

BMX055

Small, versatile 9-axis sensor module

Bosch Sensortec



BOSCH

Invented for life



BMX055: Data sheet

Document revision	1.2
Document release date	November, 2020
Document number	BST-BMX055-DS000-03
Technical reference code(s)	0 273 141 179

Notes

Data and descriptions within this document are subject to change without notice.

Product photos and pictures are for illustration purposes only and may differ from the real product's appearance.

BMX055

Basic Description

Key features

- 3 sensors in one device
 - Small package
 - Common voltage supplies
 - Digital interface
 - Smart operation and integration
 - Consumer electronics suite
- an advanced triaxial 16bit gyroscope, a versatile, leading edge triaxial 12bit accelerometer and a full performance geomagnetic sensor
LGA package 20 pins
footprint 3.0 x 4.5 mm², height 0.95mm
V_{DD} voltage range: 2.4V to 3.6V
SPI (4-wire, 3-wire), I²C, 4 interrupt pins
V_{DDIO} voltage range: 1.2V to 3.6V
All sensors can be operated individually
9-axis FusionLib software compatible
MSL1, RoHS and RoHS2 compliant, halogen-free
Operating temperature: -40°C ... +85°C

Accelerometer features

- Programmable functionality
 - On-chip FIFO
 - On-chip interrupt controller
 - On-chip temperature sensor
 - Ultra-low power IC
- Acceleration ranges $\pm 2g/\pm 4g/\pm 8g/\pm 16g$
Low-pass filter bandwidths 1kHz - <8Hz
Integrated FIFO with a depth of 32 frames
Motion-triggered interrupt-signal generation for
 - new data
 - any-motion (slope) detection
 - tap sensing (single tap / double tap)
 - orientation- & motion inactivity recognition
 - flat/low-g/high-g detectionfactory trimmed, 8-bit, typical slope 0.5K/LSB.
130 μ A current consumption, 1.3ms wake-up time, advanced features for system power management

Gyroscope features

- Programmable functionality
 - On-chip FIFO
 - On-chip interrupt controller
 - Low power IC
- Ranges switchable from $\pm 125^\circ/s$ to $\pm 2000^\circ/s$
Low-pass filter bandwidths 230Hz - 12Hz
Fast and slow offset controller (FOC and SOC)
Integrated FIFO with a depth of 100 frames
Motion-triggered interrupt-signal generation for
 - new data
 - any-motion (slope) detection
 - high rate< 5mA current consumption, 30ms start-up time
wake-up time in fast power-up mode only 10ms

Magnetometer features

- Flexible functionality
Magnetic field range typical 1300 μ T (x-, y-axis);
 \pm 2500 μ T (z-axis)
Magnetic field resolution of \sim 0.3 μ T
- On-chip interrupt controller
Interrupt-signal generation for
 - new data
 - magnetic low-/high-threshold detection
- Ultra-low power
Low current consumption (170 μ A @ 10Hz in low power preset), short wake-up time, advanced features for system power management

Typical applications

- Advanced gaming, HMI and augmented reality
- Advanced gesture recognition
- Indoor navigation
- Tilt measurement and compensation
- Free-fall detection and drop detection for warranty logging
- Display profile switching
- Advanced system power management for mobile applications
- Menu scrolling, tap / double tap sensing

General description

The BMX055 is an integrated 9-axis sensor for the detection of movements and rotations and magnetic heading. It comprises the full functionality of a triaxial, low-g acceleration sensor, a triaxial angular rate sensor and a triaxial geomagnetic sensor.

The BMX055 senses orientation, tilt, motion, acceleration, rotation, shock, vibration and heading in cell phones, handhelds, computer peripherals, man-machine interfaces, virtual reality features and game controllers.

Advanced evaluation circuitry (ASIC) converts the outputs of the micro-electromechanical and geomagnetic sensing structures (MEMS), developed, produced and tested in BOSCH facilities. The programmable on-chip interrupt engine enables motion-based applications without use of a microcontroller by providing contextual status of accelerometer, gyroscope and geomagnetic sensor. The integrated FIFO memories allow buffering the inertial sensor data.

The corresponding chip-sets are integrated into one single 20-pin LGA 3.0mm x 4.5mm x 0.95 mm housing. For optimum system integration the BMX055 is equipped with digital bi-directional SPI and I²C interfaces. To provide maximum performance and reliability each device is tested and ready-to-use calibrated.

Package and interfaces of the BMX055 have been defined to match a multitude of hardware requirements. Since the sensor features a small footprint, a flat package and very low power consumption it is ideally suited for mobile-phone and tablet PC applications.

The BMX055 offers a variable V_{DDIO} voltage range from 1.2V to 3.6V and can be programmed to optimize functionality, performance and power consumption in customer specific applications.

Index of Contents

BASIC DESCRIPTION	2
1 SPECIFICATION	10
1.1 ELECTRICAL SPECIFICATION	10
1.2 ELECTRICAL AND PHYSICAL CHARACTERISTICS, MEASUREMENT PERFORMANCE	11
2 ABSOLUTE MAXIMUM RATINGS	20
3 BLOCK DIAGRAM	21
4 BASIC POWER MANAGEMENT	22
5 FUNCTIONAL DESCRIPTION ACCELEROMETER	23
5.1 ACCELERATION DATA	23
5.2 IMU DATA ACCELEROMETER	27
5.2.1 ACCELERATION DATA	27
5.2.2 TEMPERATURE SENSOR	28
5.3 SELF-TEST ACCELEROMETER	29
5.4 OFFSET COMPENSATION ACCELEROMETER	30
5.4.1 FAST COMPENSATION	31
5.4.2 FAST COMPENSATION	31
5.4.3 MANUAL COMPENSATION	32
5.4.4 INLINE CALIBRATION	32
5.5 NON-VOLATILE MEMORY ACCELEROMETER	33
5.6 INTERRUPT CONTROLLER ACCELEROMETER	33
5.6.1 GENERAL FEATURES	34
5.6.2 MAPPING TO PHYSICAL INTERRUPT PINS (INTTYPE TO INT PIN#)	35
5.6.3 ELECTRICAL BEHAVIOR (INT PIN# TO OPEN-DRIVE OR PUSH-PULL)	35
5.6.4 NEW DATA INTERRUPT	36
5.6.5 SLOPE / ANY-MOTION DETECTION	36
5.6.6 TAP SENSING	37
5.6.7 ORIENTATION RECOGNITION	39
5.6.8 FLAT DETECTION	43
5.6.9 LOW-G INTERRUPT	44
5.6.10 HIGH-G INTERRUPT	45
5.6.11 NO-MOTION / SLOW MOTION DETECTION	45
5.7 SOFTRESET ACCELEROMETER	47
6 REGISTER DESCRIPTION ACCELEROMETER	48
6.1 GENERAL REMARKS ACCELEROMETER	48
6.2 REGISTER MAP ACCELEROMETER	49

ACC REGISTER 0x00 (BGW_CHIPID)	50
ACC REGISTER 0x01 IS RESERVED.....	50
ACC REGISTER 0x02 (ACCD_X_LSB)	50
ACC REGISTER 0x03 (ACCD_X_MSB)	51
ACC REGISTER 0x04 (ACCD_Y_LSB)	51
ACC REGISTER 0x05 (ACCD_Y_MSB)	52
ACC REGISTER 0x06 (ACCD_Z_LSB).....	52
ACC REGISTER 0x07 (ACCD_Z_MSB).....	53
ACC REGISTER 0x08 (ACCD_TEMP).....	53
ACC REGISTER 0x09 (INT_STATUS_0).....	54
ACC REGISTER 0x0A (INT_STATUS_1)	54
ACC REGISTER 0x0B (INT_STATUS_2)	55
ACC REGISTER 0x0C (INT_STATUS_3)	56
ACC REGISTER 0x0D IS RESERVED.....	56
ACC REGISTER 0x0E (FIFO_STATUS).....	56
ACC REGISTER 0x0F (PMU_RANGE).....	57
ACC REGISTER 0x10 (PMU_BW)	57
ACC REGISTER 0x11 (PMU_LPW)	58
ACC REGISTER 0x12 (PMU_LOW_POWER)	58
ACC REGISTER 0x13 (ACCD_HBW)	59
ACC REGISTER 0x14 (BGW_SOFTRESET).....	60
ACC REGISTER 0x15 IS RESERVED.....	60
ACC REGISTER 0x16 (INT_EN_0)	60
ACC REGISTER 0x17 (INT_EN_1)	61
ACC REGISTER 0x18 (INT_EN_2)	61
ACC REGISTER 0x19 (INT_MAP_0)	62
ACC REGISTER 0x1A (INT_MAP_1).....	62
ACC REGISTER 0x1B (INT_MAP_2).....	63
ACC REGISTER 0x1C IS RESERVED.....	63
ACC REGISTER 0x1D IS RESERVED.....	63
ACC REGISTER 0x1E (INT_SRC)	63
ACC REGISTER 0x1F IS RESERVED	64
ACC REGISTER 0x20 (INT_OUT_CTRL).....	64
ACC REGISTER 0x21 (INT_RST_LATCH).....	65
ACC REGISTER 0x22 (INT_0)	65
ACC REGISTER 0x23 (INT_1)	66
ACC REGISTER 0x24 (INT_2).....	66
ACC REGISTER 0x25 (INT_3).....	66
ACC REGISTER 0x26 (INT_4).....	67
ACC REGISTER 0x27 (INT_5).....	67
ACC REGISTER 0x28 (INT_6).....	68
ACC REGISTER 0x29 (INT_7)	69
ACC REGISTER 0x2A (INT_8).....	69
ACC REGISTER 0x2B (INT_9).....	70
ACC REGISTER 0x2C (INT_A)	70
ACC REGISTER 0x2D (INT_B)	71
ACC REGISTER 0x2E (INT_C)	71
ACC REGISTER 0x2F (INT_D)	72
ACC REGISTER 0x30 (FIFO_CONFIG_0).....	72
ACC REGISTER 0x31 IS RESERVED.....	73
ACC REGISTER 0x32 (PMU_SELF_TEST).....	73
ACC REGISTER 0x33 (TRIM_NVM_CTRL).....	73
ACC REGISTER 0x34 (BGW_SPI3_WDT)	74
ACC REGISTER 0x35 IS RESERVED.....	74
ACC REGISTER 0x36 (OFC_CTRL).....	74
ACC REGISTER 0x37 (OFC_SETTING).....	75

ACC REGISTER 0x38 (OFC_OFFSET_X).....	76
ACC REGISTER 0x39 (OFC_OFFSET_Y).....	76
ACC REGISTER 0x3A (OFC_OFFSET_Z)	77
ACC REGISTER 0x3B (TRIM_GP0)	77
ACC REGISTER 0x3C (TRIM_GP1)	78
ACC REGISTER 0x3D IS RESERVED.....	78
ACC REGISTER 0x3E (FIFO_CONFIG_1)	78
ACC REGISTER 0x3F (FIFO_DATA).....	79
7 FUNCTIONAL DESCRIPTION GYROSCOPE	80
7.1 POWER MODES GYROSCOPE.....	80
7.1.1 ADVANCED POWER-SAVING MODES.....	81
7.2 BMX055 DATA GYROSCOPE.....	83
7.2.1 RATE DATA.....	83
7.3 ANGULAR RATE READ-OUT.....	84
7.4 SELF-TEST GYRO.....	84
7.5 OFFSET COMPENSATION GYROSCOPE.....	84
7.5.1 SLOW COMPENSATION.....	85
7.5.2 FAST COMPENSATION.....	85
7.5.3 MANUAL COMPENSATION.....	86
7.5.4 INLINE CALIBRATION.....	86
7.6 NON-VOLATILE MEMORY GYROSCOPE	86
7.7 INTERRUPT CONTROLLER GYROSCOPE	87
7.7.1 GENERAL FEATURES	87
7.7.2 MAPPING TO PHYSICAL INTERRUPT PINS (INTTYPE TO INT PIN#).....	88
7.7.3 ELECTRICAL BEHAVIOUR (INT PIN# TO OPEN-DRIVE OR PUSH-PULL)	88
7.7.4 NEW DATA INTERRUPT.....	88
7.7.5 ANY-MOTION DETECTION / INTERRUPT	89
7.7.6 HIGH-RATE INTERRUPT.....	90
8 REGISTER DESCRIPTION GYROSCOPE	91
8.1 GENERAL REMARKS.....	91
8.2 REGISTER MAP GYROSCOPE	92
GYR REGISTER 0x00 (CHIP_ID)	93
GYR REGISTER 0x01 IS RESERVED	93
GYR REGISTER 0x02 (RATE_X_LSB).....	93
GYR REGISTER 0x03 (RATE_X_MSB).....	94
GYR REGISTER 0x04 (RATE_Y_LSB).....	94
GYR REGISTER 0x05 (RATE_Y_MSB).....	95
GYR REGISTER 0x06 (RATE_Z_LSB).....	95
GYR REGISTER 0x07 (RATE_Z_MSB)	96
GYR REGISTER 0x08 RESERVED.....	96
GYR REGISTER 0x09 (INT_STATUS_0).....	96
GYR REGISTER 0x0A (INT_STATUS_1)	97
GYR REGISTER 0x0B (INT_STATUS_2)	97
GYR REGISTER 0x0C (INT_STATUS_3).....	97
GYR REGISTER 0x0D IS RESERVED.....	98

GYR REGISTER 0x0E (FIFO_STATUS).....	98
GYR REGISTER 0x0F (RANGE).....	99
GYR REGISTER 0x10 (BW).....	99
GYR REGISTER 0x11 (LPM1).....	100
GYR REGISTER 0x12 (LPM2).....	101
GYR REGISTER 0x13 (RATE_HBW).....	102
GYR REGISTER 0x14 (BGW_SOFTRESET).....	103
GYR REGISTER 0x15 (INT_EN_0).....	103
GYR REGISTER 0x16 (INT_EN_1).....	104
GYR REGISTER 0x17 (INT_MAP_0).....	104
GYR REGISTER 0x18 (INT_MAP_1).....	104
GYR REGISTER 0x19 (INT_MAP_2).....	105
GYR REGISTER 0x1A.....	106
GYR REGISTER 0x1B.....	106
GYR REGISTER 0x1C.....	106
GYR REGISTER 0x1D IS RESERVED.....	107
GYR REGISTER 0x1E.....	107
GYR REGISTER 0x1F AND 0x20 ARE RESERVED.....	107
GYR REGISTER 0x21 (INT_RST_LATCH).....	108
GYR REGISTER 0x22 (HIGH_TH_X).....	108
GYR REGISTER 0x23 (HIGH_DUR_X).....	109
GYR REGISTER 0x24 (HIGH_TH_Y).....	109
GYR REGISTER 0x25 (HIGH_DUR_Y).....	110
GYR REGISTER 0x26 (HIGH_TH_Z).....	110
GYR REGISTER 0x27 (HIGH_DUR_Z).....	111
GYR REGISTER 0x28 TO 0x30 ARE RESERVED.....	111
GYR REGISTER 0x31 (SOC).....	111
GYR REGISTER 0x32 (A_FOC).....	112
GYR REGISTER 0x33 (TRIM_NVM_CTRL).....	112
GYR REGISTER 0x34 (BGW_SPI3_WDT).....	113
GYR REGISTER 0x35 IS RESERVED.....	113
GYR REGISTER 0x36 (OFC1).....	114
GYR REGISTER 0x37 (OFC2).....	114
GYR REGISTER 0x38 (OFC3).....	115
GYR REGISTER 0x39 (OFC4).....	115
GYR REGISTER 0x3A (TRIM_GP0).....	116
GYR REGISTER 0x3B (TRIM_GP1).....	116
GYR REGISTER 0x3C (BIST).....	117
GYR REGISTER 0x3D (FIFO_CONFIG_0).....	117
GYR REGISTER 0x3E (FIFO_CONFIG_1).....	118

9 FUNCTIONAL DESCRIPTION MAGNETOMETER.....	120
9.1 MAGNETOMETER POWER MANAGEMENT.....	120
9.2 MAGNETOMETER POWER MODES.....	120
9.2.1 POWER OFF MODE.....	120
9.2.2 SUSPEND MODE.....	120
9.2.3 SLEEP MODE.....	120
9.2.4 ACTIVE MODE.....	120
9.3 MAGNETOMETER OUTPUT DATA.....	122
9.3.1 MAGNETIC FIELD DATA.....	122
9.3.2 MAGNETIC FIELD DATA TEMPERATURE COMPENSATION.....	123
9.4 SELF-TEST MAGNETOMETER.....	124

9.4.1	NORMAL SELF TEST.....	124
9.4.2	ADVANCED SELF TEST.....	124
9.5	NON-VOLATILE MEMORY	125
9.6	MAGNETOMETER INTERRUPT CONTROLLER.....	125
9.6.1	GENERAL FEATURES	126
9.6.2	ELECTRICAL BEHAVIOR OF MAGNETIC INTERRUPT PINS	127
9.6.3	DATA READY / DRDY INTERRUPT.....	127
9.6.4	LOW-THRESHOLD INTERRUPT.....	127
9.6.5	HIGH-THRESHOLD INTERRUPT.....	128
9.6.6	OVERFLOW.....	129
10	REGISTER DESCRIPTION MAGNETOMETER	130
10.1	GENERAL REMARKS.....	130
10.2	REGISTER MAP MAGNETOMETER.....	130
10.3	CHIP ID MAGNETOMETER	131
	MAG REGISTER (0x40)	131
	MAG REGISTER (0x41) IS RESERVED.....	131
10.4	MAGNETIC FIELD DATA.....	131
	MAG REGISTER (0x42)	131
	MAG REGISTER (0x43)	131
	MAG REGISTER (0x44)	132
	MAG REGISTER (0x45)	132
	MAG REGISTER (0x46)	132
	MAG REGISTER (0x47)	133
	MAG REGISTER (0x48)	133
	MAG REGISTER (0x49)	133
10.5	INTERRUPT STATUS REGISTER MAGNETOMETER.....	134
	MAG REGISTER (0x4A).....	134
10.6	POWER AND OPERATION MODES, SELF-TEST, DATA OUTPUT RATE CONTROL REGISTERS	134
	MAG REGISTER (0x4B).....	134
	MAG REGISTER (0x4C).....	135
10.7	INTERRUPT AND AXIS ENABLE SETTINGS CONTROL REGISTERS.....	136
	MAG REGISTER (0x4D).....	136
	MAG REGISTER (0x4E).....	137
	MAG REGISTER (0x4F).....	137
	MAG REGISTER (0x50)	138
10.8	NUMBER OF REPETITIONS CONTROL REGISTERS	138
	MAG REGISTER (0x51)	138
	MAG REGISTER (0x52)	139
11	DIGITAL INTERFACE OF THE DEVICE.....	140
11.1	SERIAL PERIPHERAL INTERFACE (SPI)	141
11.2	INTER-INTEGRATED CIRCUIT (I ² C)	145
11.2.1	SPI AND I ² C ACCESS RESTRICTIONS	149

12	FIFO OPERATION	150
12.1	FIFO OPERATING MODES.....	150
12.2	FIFO DATA READOUT.....	151
12.2.1	DATA READOUT ACCELEROMETER.....	151
12.2.2	DATA READOUT GYROSCOPE.....	152
12.2.3	EXTERNAL FIFO SYNCHRONIZATION (EFS) FOR THE GYROSCOPE.....	152
12.3	FIFO FRAME COUNTER AND OVERRUN FLAG	153
12.4	FIFO INTERRUPTS.....	153
13	PIN-OUT AND CONNECTION DIAGRAM	155
13.1	PIN-OUT	155
13.2	CONNECTION DIAGRAM 4-WIRE SPI.....	157
13.3	CONNECTION DIAGRAM 3-WIRE SPI.....	158
13.4	CONNECTION DIAGRAM I ² C	159
14	PACKAGE	160
14.1	OUTLINE DIMENSIONS.....	160
14.2	SENSING AXES ORIENTATION	161
14.3	ANDROID AXES ORIENTATION.....	162
14.4	LANDING PATTERN RECOMMENDATION	164
14.5	MARKING	165
14.5.1	MASS PRODUCTION DEVICES.....	165
14.5.2	ENGINEERING SAMPLES.....	165
14.6	SOLDERING GUIDELINES	166
14.7	HANDLING INSTRUCTIONS.....	167
14.8	TAPE AND REEL SPECIFICATION.....	168
14.8.1	ORIENTATION WITHIN THE REEL	168
14.9	ENVIRONMENTAL SAFETY	168
14.9.1	HALOGEN CONTENT.....	169
14.9.2	INTERNAL PACKAGE STRUCTURE	169
15	LEGAL DISCLAIMER	170
15.1	ENGINEERING SAMPLES.....	170
15.2	PRODUCT USE.....	170
15.3	APPLICATION EXAMPLES AND HINTS.....	170
16	DOCUMENT HISTORY AND MODIFICATION	171

1 Specification

If not stated otherwise, the given values are over lifetime and full performance temperature and voltage ranges, minimum/maximum values are $\pm 3\sigma$.

1.1 Electrical specification

Table 1: Electrical parameter specification

OPERATING CONDITIONS						
Parameter	Symbol	Condition	Min	Typ	Max	Unit
Supply Voltage Internal Domains	V_{DD}		2.4	3.0	3.6	V
Supply Voltage I/O Domain	V_{DDIO}		1.2	2.4	3.6	V
Voltage Input Low Level	$V_{IL,a}$	SPI & I ² C			$0.3V_{DDIO}$	-
Voltage Input High Level	$V_{IH,a}$	SPI & I ² C	$0.7V_{DDIO}$			-
Voltage Output Low Level	$V_{OL,a}$	$I_{OL} = 3mA$, SPI & I ² C			$0.23V_{DDIO}$	-
Voltage Output High Level	V_{OH}	$I_{OH} = 3mA$, SPI	$0.8V_{DDIO}$			-
Operating Temperature	T_A		-40		+85	°C

1.2 Electrical and physical characteristics, measurement performance

Table 2: Electrical characteristics accelerometer

OPERATING CONDITIONS ACCELEROMETER						
Parameter	Symbol	Condition	Min	Typ	Max	Units
Acceleration Range	g_{FS2g}	Selectable via serial digital interface		± 2		g
	g_{FS4g}			± 4		g
	g_{FS8g}			± 8		g
	g_{FS16g}			± 16		g
Total Supply Current in Normal Mode	I_{DD}	see ¹		130		μA
Total Supply Current in Suspend Mode	I_{DDsum}	see ¹		2.1		μA
Total Supply Current in Deep Suspend Mode	I_{DDdsum}	see ¹		1.0		μA
Total Supply Current in Low-power Mode 1	I_{DDlp1}	see ¹ sleep duration $\geq 25ms$		6.5		μA
Total Supply Current in Low-power Mode 2	I_{DDlp2}	see ¹ sleep duration $\geq 25ms$		66		μA
Total Supply Current in Standby Mode	I_{DDsbm}	see ¹		62		μA
Wake-Up Time 1	$t_{w,up1}$	from Low-power Mode 1 or Suspend Mode or Deep Suspend Mode bw = 1kHz		1.3		ms
Wake-Up Time 2	$t_{w,up2}$	from Low-power Mode 2 or Stand-by Mode bw = 1kHz		1		ms
Start-Up Time	$t_{s,up}$	POR, bw = 1kHz				ms
Non-volatile memory (NVM) write-cycles	n_{NVM}				15	Cycles

¹ Conditions of current consumption if not specified otherwise: $T_A=25^\circ C$, $BW_Accel=1kHz$, $V_{DD} = V_{DDIO} = 2.4V$, digital protocol on, no streaming data

OUTPUT SIGNAL ACCELEROMETER						
Parameter	Symbol	Condition	Min	Typ	Max	Units
Sensitivity	S_{2g}	$g_{FS2g}, T_A=25^\circ C$		1024		LSB/g
	S_{4g}	$g_{FS4g}, T_A=25^\circ C$		512		LSB/g
	S_{8g}	$g_{FS8g}, T_A=25^\circ C$		256		LSB/g
	S_{16g}	$g_{FS16g}, T_A=25^\circ C$		128		LSB/g
Sensitivity Temperature Drift	TCS	g_{FS2g} , Nominal V_{DD} supplies		± 0.03		%/K
Sensitivity Supply Volt. Drift	S_{VDD}	$g_{FS2g}, T_A=25^\circ C$, $V_{DD_min} \leq V_{DD} \leq V_{DD_max}$		0.05		%/V
Zero-g Offset (x,y,z)	$Off_{x,z}$	$g_{FS2g}, T_A=25^\circ C$, nominal V_{DD} supplies, over life-time		± 80		mg
Zero-g Offset Temperature Drift	TCO	g_{FS2g} , Nominal V_{DD} supplies		± 1		mg/K
Zero-g Offset Supply Volt. Drift	Off_{VDD}	$g_{FS2g}, T_A=25^\circ C$, $V_{DD_min} \leq V_{DD} \leq V_{DD_max}$		0.5		mg/V
Bandwidth	bw_8	2 nd order filter, bandwidth programmable		8		Hz
	bw_{16}			16		Hz
	bw_{31}			31		Hz
	bw_{63}			63		Hz
	bw_{125}			125		Hz
	bw_{250}			250		Hz
	bw_{500}			500		Hz
	bw_{1000}			1,000		Hz
Nonlinearity	NL	best fit straight line, g_{FS2g}	-1	± 0.5	+1	%FS
Output Noise Density	n_{rms}	$g_{FS2g}, T_A=25^\circ C$ Nominal V_{DD} supplies Normal mode		150		$\mu g/\sqrt{Hz}$
Temperature Sensor Measurement Range	T_s		-40		85	$^\circ C$
Temperature Sensor Slope	dT_s			0.5		K/LSB
Temperature Sensor Offset	OT_s			± 2		K

**MECHANICAL CHARACTERISTICS ACCELEROMETER**

Parameter	Symbol	Condition	Min	Typ	Max	Units
Cross Axis Sensitivity	S	relative contribution between any two of the three axes		1		%
Alignment Error	E _A	relative to package outline		±0.5		deg

Table 3: Electrical characteristics gyroscope

OPERATING CONDITIONS GYROSCOPE						
Parameter	Symbol	Condition	Min	Typ	Max	Unit
Range	R _{FS125}	Selectable via serial digital interface		125		°/s
	R _{FS250}			250		°/s
	R _{FS500}			500		°/s
	R _{FS1000}			1,000		°/s
	R _{FS2000}			2,000		°/s
Supply Current in Normal Mode	I _{DD}	see ²		5		mA
Supply Current in Fast Power-up Mode	I _{DDfpm}	see ²		2.5		mA
Supply Current in Suspend Mode	I _{DDsum}	see ² , digital and analog (only IF active)		25		μA
Supply Current in Deep Suspend Mode	I _{DDdsum}	see ²		<5		μA
Start-up time	t _{su}	to ±1%/s of final value; from power-off		30		ms
Wake-up time	t _{wusm}	From suspend- and deep suspend-modes		30		ms
Wake-up time	t _{wufpm}	From fast power-up mode		10		ms
Non-volatile memory (NVM) write-cycles	n _{NVM}				15	cycles

² Conditions of current consumption if not specified otherwise: T_A=25°C, BW_Gyro=1kHz, V_{DD}=2.4V, V_{DDIO}=1.8V, digital protocol on, no streaming data

OUTPUT SIGNAL GYROSCOPE						
Parameter	Symbol	Condition	Min	Typ	Max	Unit
Sensitivity		Ta=25°C, R _{FS2000}		16.4		LSB/°/s
		Ta=25°C, R _{FS1000}		32.8		LSB/°/s
		Ta=25°C, R _{FS500}		65.6		LSB/°/s
		Ta=25°C, R _{FS250}		131.2		LSB/°/s
		Ta=25°C, R _{FS125}		262.4		LSB/°/s
Sensitivity tolerance		Ta=25°C, R _{FS2000}		±1		%
Sensitivity Change over Temperature	TCS	Nominal V _{DD} supplies -40°C ≤ T _A ≤ +85°C R _{FS2000}		±0.03		%/K
Sensitivity Supply Volt. Drift	S _{VDD}	T _A =25°C, V _{DD_min} ≤ V _{DD} ≤ V _{DD_max}		<0.4		%/V
Nonlinearity	NL	best fit straight line R _{FS1000} , R _{FS2000}		±0.05		%FS
g- Sensitivity		Sensitivity to acceleration stimuli in all three axis (frequency <20kHz)			0.1	°/s/g
Zero-rate Offset	Off Ω _x Ω _y and Ω _z	Nominal V _{DD} supplies T _A =25°C, slow and fast offset cancellation off		±1		°/s
Zero-Ω Offset Change over Temperature	TCO	Nominal V _{DD} supplies -40°C ≤ T _A ≤ +85°C R _{FS2000}		±0.015		°/s per K
Zero-Ω Offset Supply Volt. Drift	OffΩ _{VDD}	T _A =25°C, V _{DD_min} ≤ V _{DD} ≤ V _{DD_max}		<0.1		°/s /V
Output Noise	n _{rms}	rms, BW=47Hz (@ 0.014°/s/√Hz)		0.1		°/s



Bandwidth BW	f_{-3dB}			unfiltered 230 116 64 47 32 23 12		Hz
Data rate (set of x,y,z rate)				2000 1000 400 200 100		Hz
Data rate tolerance (set of x,y,z rate)				±0.3		%
Cross Axis Sensitivity		Sensitivity to stimuli in non-sense-direction		±1		%

Table 4: Electrical characteristics magnetometer

OPERATING CONDITIONS MAGNETOMETER						
Parameter	Symbol	Condition	Min	Typ	Max	Units
Magnetic field range ³	Brg,xy	TA=25°C	±1200	±1300		µT
	Brg,z		±2000	±2500		µT
Magnetometer heading accuracy ⁴	AC _{heading}	30µT horizontal geomagnetic field component, TA=25°C			±2.5	deg
System heading accuracy ⁵	AS _{heading}	30µT horizontal geomagnetic field component, TA=25°C			±3.0	deg
Supply Current in Active Mode (average) ⁶	IDD,lp,m	Low power preset Nominal VDD supplies TA=25°C, ODR=10Hz		170		µA
	IDD,rg,m	Regular preset Nominal VDD supplies TA=25°C, ODR=10Hz		0.5		mA
	IDD,eh,m	Enhanced regular preset Nominal VDD supplies TA=25°C, ODR=10Hz		0.8		mA
	IDD,ha,m	High accuracy preset Nominal VDD supplies TA=25°C, ODR=20Hz		4.9		mA
Supply Current in Suspend Mode	IDDsm,m	Nominal VDD/VDDIO supplies, TA=25°C		1		µA
Peak supply current in Active Mode	IDDpk,m	In measurement phase Nominal VDD supplies TA=25°C		18		mA
Peak logic supply current in active mode	IDDIOPk,m	Only during measurement phase Nominal VDDIO supplies TA=25°C		210		µA
POR time	tw _{up} ,m	from OFF to Suspend; time starts when VDD>1.5V and VDDIO>1.1V			1.0	ms
Start-Up Time	ts _{up} ,m	from Suspend to sleep			3.0	ms

³ Full linear measurement range considering sensor offsets.

⁴ The heading accuracy depends on hardware and software. For detailed information of the software performance please contact Bosch Sensortec.

⁵ Heading accuracy of the tilt-compensated 9-axis system, assuming calibration with Bosch Sensortec FusionLib software. Average value over various device orientations (typical device usage).

⁶ For details on magnetometer current consumption calculation refer to chapter 9.2.4

MAGNETOMETER OUTPUT SIGNAL						
Parameter	Symbol	Condition	Min	Typ	Max	Unit
Device Resolution	$D_{res,m}$	$T_A=25^{\circ}C$		0.3		μT
Gain error ⁷	$G_{err,m}$	After API compensation $T_A=25^{\circ}C$ Nominal V_{DD} supplies		± 5		%
Sensitivity Temperature Drift	TCS_m	After API compensation $-40^{\circ}C \leq T_A \leq +85^{\circ}C$ Nominal V_{DD} supplies		± 0.01		%/K
Zero-B offset	OFF_m	$T_A=25^{\circ}C$		± 40		μT
Zero-B offset ⁸	$OFF_{m,cal}$	After software calibration with Bosch Sensortec eCompass software $-40^{\circ}C \leq T_A \leq +85^{\circ}C$		± 2		μT
	odr_{lp}	Low power preset		10		Hz
ODR (data output rate), normal mode	odr_{rg}	Regular preset		10		Hz
	odr_{eh}	Enhanced regular preset		10		Hz
	odr_{ha}	High accuracy preset		20		Hz
ODR (data output rate), forced mode	odr_{lp}	Low power preset	0		>300	Hz
	odr_{rg}	Regular preset	0		100	Hz
	odr_{eh}	Enhanced regular preset	0		60	Hz
	odr_{ha}	High accuracy preset	0		20	Hz
Full-scale Nonlinearity	$NL_{m,FS}$	best fit straight line			1	%FS
Output Noise	$n_{rms,lp,m,xy}$	Low power preset x, y-axis, $T_A=25^{\circ}C$ Nominal V_{DD} supplies		1.0		μT
	$n_{rms,lp,m,z}$	Low power preset z-axis, $T_A=25^{\circ}C$ Nominal V_{DD} supplies		1.4		μT
	$n_{rms,rg,m}$	Regular preset $T_A=25^{\circ}C$ Nominal V_{DD} supplies		0.6		μT
	$n_{rms,eh,m}$	Enhanced regular preset $T_A=25^{\circ}C$ Nominal V_{DD} supplies		0.5		μT

⁷ Definition: $gain\ error = (measured\ field\ after\ API\ compensation) / (applied\ field) - 1$

⁸ Magnetic zero-B offset assuming calibration with Bosch Sensortec eCompass software. Typical value after applying calibration movements containing various device orientations (typical device usage).



	$\eta_{\text{rms,ha,m}}$	High accuracy preset $T_A=25^\circ\text{C}$ Nominal V_{DD} supplies		0.3		μT
Power Supply Rejection Rate	PSRR _m	$T_A=25^\circ\text{C}$ Nominal V_{DD} supplies		± 0.5		$\mu\text{T/V}$

2 Absolute maximum ratings

Table 5: Absolute maximum ratings

Parameter	Condition	Min	Max	Units
Voltage at Supply Pin	V _{DD} Pin	-0.3	4.25	V
	V _{DDIO} Pin	-0.3	4.25	V
Voltage at any Logic Pin	Non-Supply Pin	-0.3	V _{DDIO} +0.3	V
Passive Storage Temp. Range	≤ 65% rel. H.	-50	+150	°C
None-volatile memory (NVM) Data Retention	T = 85°C, after 15 cycles	10		y
Mechanical Shock	Duration ≤ 200μs		10,000	g
	Duration ≤ 1.0ms		2,000	g
	Free fall onto hard surfaces		1.8	m
ESD	HBM, at any Pin		2	kV
	CDM		500	V
	MM		200	V

Note: Stress above these limits may cause damage to the device. Exceeding the specified electrical limits may affect the device reliability or cause malfunction.

3 Block diagram

Figure 1 shows the basic building blocks of the BMX055:

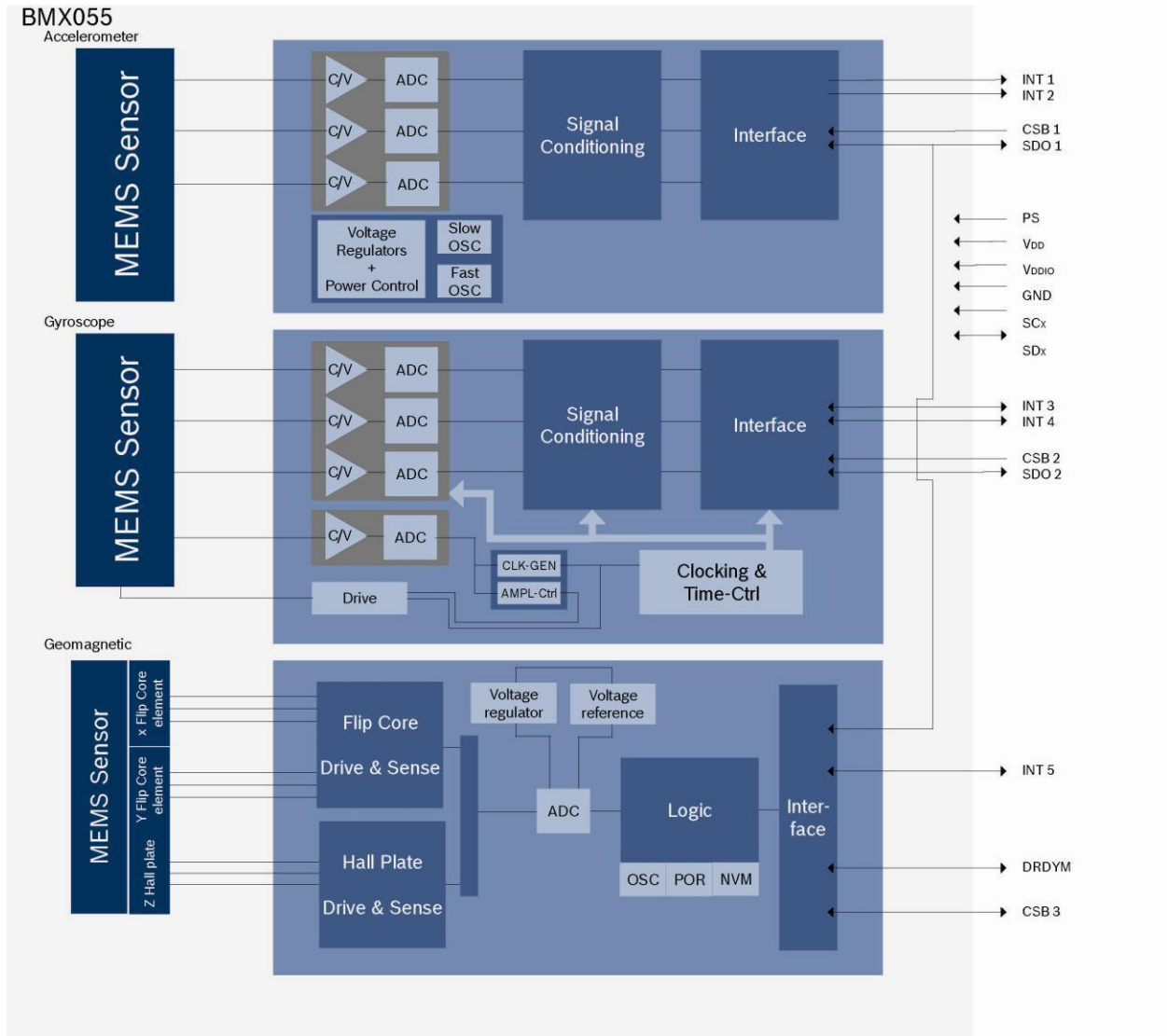

Figure 1: Block diagram of the BMX055

4 Basic power management

The BMX055 has two distinct power supply pins:

- V_{DD} is the main power supply for the internal blocks
- V_{DDIO} is a separate power supply pin mainly used for the supply of the interface

There are no limitations on the voltage levels of both pins relative to each other, as long as each of them lies within its operating range. Furthermore, the device can be completely switched off ($V_{DD} = 0V$) while keeping the V_{DDIO} supply on ($V_{DDIO} > 0V$) or vice versa.

When the V_{DDIO} supply is switched off, all interface pins (CSB, SDI, SCK, PS) must be kept close to GND_{IO} potential.

The device contains a power-on reset (POR) generator. It resets the logic part and the register values after powering-on V_{DD} and V_{DDIO} . Please note, that all application specific settings which are not equal to the default settings (refer to 6.2 register map accelerometer, to 8.2 register map gyroscope and to 10.2 register map magnetometer), must be re-set to its designated values after POR.

In case the I²C interface shall be used, a direct electrical connection between V_{DDIO} supply and the PS pin is needed in order to ensure reliable protocol selection. For SPI interface mode the PS pin must be directly connected to GND_{IO} .

5 Functional description accelerometer

Note: Default values for registers can be found in Chapter 6.

5.1 Acceleration data

The accelerometer has six different power modes. Besides normal mode, which represents the fully operational state of the device, there are five energy saving modes: deep-suspend mode, suspend mode, standby mode, low-power mode 1 and low-power mode 2.

The possible transitions between the power modes are illustrated in Figure 2:

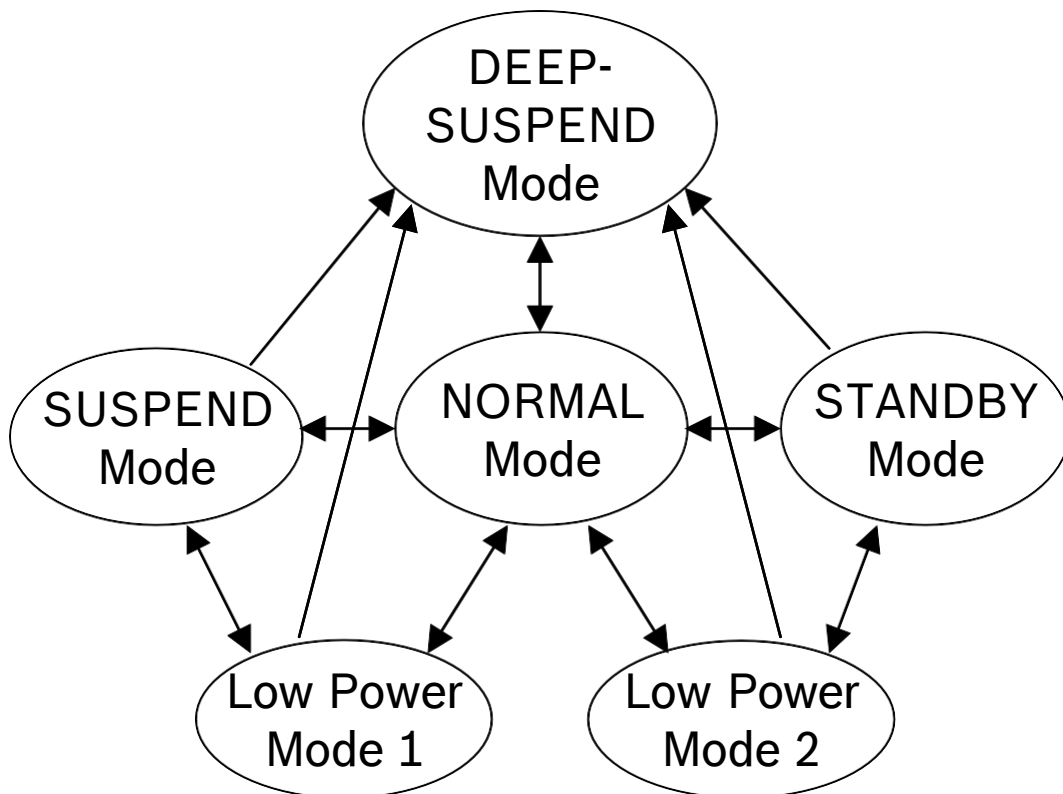

Figure 2: Power mode transition diagram

After power-up accelerometer is in normal mode so that all parts of the device are held powered-up and data acquisition is performed continuously.

In **deep-suspend** mode the device reaches the lowest possible power consumption. Only the interface section is kept alive. No data acquisition is performed and the content of the configuration registers is lost. Deep suspend mode is entered (left) by writing '1' ('0') to the (ACC 0x11) *deep_suspend* bit while (ACC 0x11) *suspend* bit is set to '0'. The I²C watchdog timer remains functional. The (ACC 0x11) *deep_suspend* bit, the (ACC 0x34) *spi3* bit, (ACC 0x34) *i2c_wdt_en* bit and the (ACC 0x34) *i2c_wdt_sel* bit are functional in deep-suspend mode. Equally the interrupt level and driver configuration registers (ACC 0x20) *int1_lvl*, (ACC 0x20) *int1_od*, (ACC 0x20) *int2_lvl*, and (ACC 0x20) *int2_od* are accessible. Still it is possible to enter normal mode by performing a softreset as described in chapter 5.7. Please note, that all

application specific settings which are not equal to the default settings (refer to 6.2 register map accelerometer), must be re-set to its designated values after leaving deep-suspend mode.

In **suspend mode** the whole analog part is powered down. No data acquisition is performed. While in suspend mode the latest acceleration data and the content of all configuration registers are kept. Writing to and reading from registers is supported except from the (0x3E) `fifo_config_1`, (0x30) `fifo_config_0` and (0x3F) `fifo_data` register. It is possible to enter normal mode by performing a softreset as described in chapter 5.7.

Suspend mode is entered (left) by writing '1' ('0') to the (ACC 0x11) `suspend` bit after bit (ACC 0x12) `lowpower_mode` has been set to '0'. Although write access to registers is supported at the full interface clock speed (SCL or SCK), a waiting period must be inserted between two consecutive write cycles (please refer also to section 9.2.1).

In **standby mode** the analog part is powered down, while the digital part remains largely operational. No data acquisition is performed. Reading and writing registers is supported without any restrictions. The latest acceleration data and the content of all configuration registers are kept. Standby mode is entered (left) by writing '1' ('0') to the (ACC 0x11) `suspend` bit after bit (ACC 0x12) `lowpower_mode` has been set to '1'. It is also possible to enter normal mode by performing a softreset as described in chapter 5.7.

In **low-power mode 1**, the device is periodically switching between a sleep phase and a wake-up phase. The wake-up phase essentially corresponds to operation in normal mode with complete power-up of the circuitry. The sleep phase essentially corresponds to operation in suspend mode. Low-power mode is entered (left) by writing '1' ('0') to the (ACC 0x11) `lowpower_en` bit with bit (ACC 0x12) `lowpower_mode` set to '0'. Read access to registers is possible except from the (0x3F) `fifo_data` register. However, unless the register access is synchronised with the wake-up phase, the restrictions of the suspend mode apply.

Low-power mode 2 is very similar to low-power mode 1, but register access is possible at any time without restrictions. It consumes more power than low-power mode 1. In low-power mode 2 the device is periodically switching between a sleep phase and a wake-up phase. The wake-up phase essentially corresponds to operation in normal mode with complete power-up of the circuitry. The sleep phase essentially corresponds to operation in standby mode. Low-power mode is entered (left) by writing '1' ('0') to the (ACC 0x11) `lowpower_en` bit with bit (ACC 0x12) `lowpower_mode` set to '1'.

The timing behaviour of the low-power modes 1 and 2 depends on the setting of the (ACC 0x12) `sleeptimer_en` bit. When (ACC 0x12) `sleeptimer_en` is set to '0', the event-driven time-base mode (EDT) is selected. In EDT the duration of the wake-up phase depends on the number of samples required by the enabled interrupt engines. If an interrupt is detected, the device stays in the wake-up phase as long as the interrupt condition endures (non-latched interrupt), or until the latch time expires (temporary interrupt), or until the interrupt is reset (latched interrupt). If no interrupt is detected, the device enters the sleep phase immediately after the required number of acceleration samples have been taken and an active interface access cycle has ended. The EDT mode is recommended for power-critical applications which do not use the FIFO. Also, EDT mode is compatible with legacy BST sensors. Figure 3 shows the timing diagram for low-power modes 1 and 2 when EDT is selected.

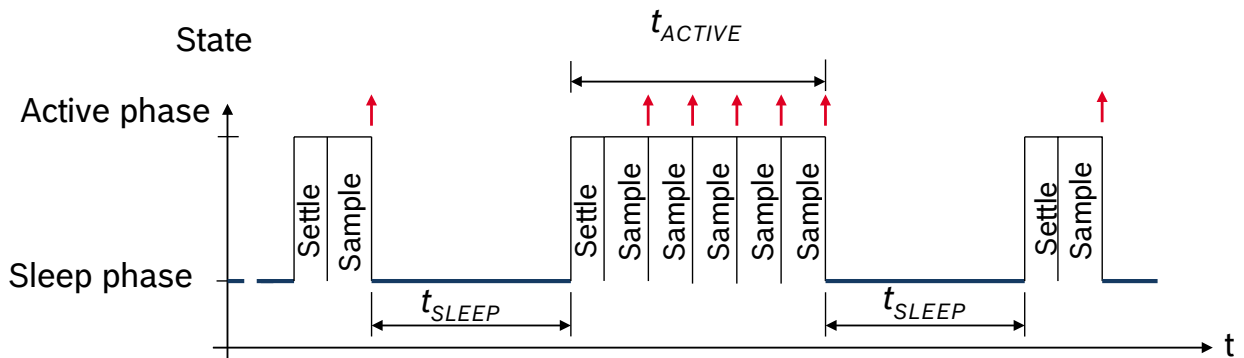

Figure 3: Timing Diagram for low-power mode 1/2, EDT

When (*ACC 0x12*) *sleeptimer_en* is set to '1', the equidistant-sampling mode (EST) is selected. The use of the EST mode is recommended when the FIFO is used since it ensures that equidistant samples are sampled into the FIFO regardless of whether the active phase is extended by active interrupt engines or interface activity. In EST mode the sleep time t_{SLEEP} is defined as shown in Figure 4. The FIFO sampling time t_{SAMPLE} is the sum of the sleep time t_{SLEEP} and the sensor data sampling time t_{SSMP} . Since interrupt engines can extend the active phase to exceed the sleep time t_{SLEEP} , equidistant sampling is only guaranteed if the bandwidth has been chosen such that $1/(2 * bw) = n * t_{SLEEP}$ where n is an integer. If this condition is infringed, equidistant sampling is not possible. Once the sleep time has elapsed the device will store the next available sample in the FIFO. This set-up condition is not recommended as it may result in timing jitter.

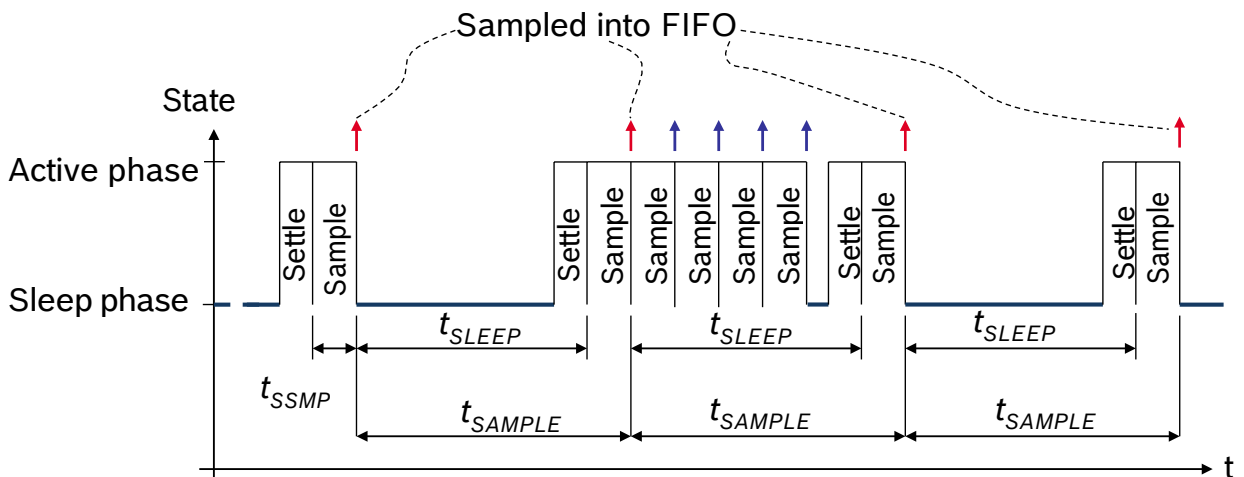

Figure 4: Timing Diagram for low-power mode 1/2, EST

The sleep time for lower-power mode 1 and 2 is set by the (ACC 0x11) *sleep_dur* bits as shown in the following table:

Table 6: Sleep phase duration settings

(ACC 0x11) <i>sleep_dur</i>	Sleep Phase Duration t_{sleep}
0000b	0.5ms
0001b	0.5ms
0010b	0.5ms
0011b	0.5ms
0100b	0.5ms
0101b	0.5ms
0110b	1ms
0111b	2ms
1000b	4ms
1001b	6ms
1010b	10ms
1011b	25ms
1100b	50ms
1101b	100ms
1110b	500ms
1111b	1s

The current consumption of the accelerometer in low-power mode 1 (I_{DDlp1}) and low-power mode 2 (I_{DDlp2}) can be estimated according to the following formulae:

$$I_{DDlp1} \approx \frac{t_{sleep} \cdot I_{DDsum} + t_{active} \cdot I_{DD}}{t_{sleep} + t_{active}}$$

$$I_{DDlp2} \approx \frac{t_{sleep} \cdot I_{DDsbm} + t_{active} \cdot I_{DD}}{t_{sleep} + t_{active}}$$

When estimating the length of the wake-up phase t_{active} , the corresponding typical wake-up time, $t_{w,up1}$ or $t_{w,up2}$ and t_{ut} (given in Table 7) have to be considered:

If bandwidth is ≥ 31.25 Hz:

$$t_{active} = t_{ut} + t_{w,up1} - 0.9 \text{ ms (or } t_{active} = t_{ut} + t_{w,up2} - 0.9 \text{ ms)}$$

else:

$$t_{active} = 4 t_{ut} + t_{w,up1} - 0.9 \text{ ms (or } t_{active} = 4 t_{ut} + t_{w,up2} - 0.9 \text{ ms)}$$

During the wake-up phase all analog modules are held powered-up, while during the sleep phase most analog modules are powered down. Consequently, a wake-up time of more than $t_{w,up1}$ ($t_{w,up2}$) ms is needed to settle the analog modules so that reliable acceleration data are generated.

5.2 IMU data accelerometer

5.2.1 Acceleration data

The width of acceleration data is 12 bits given in two's complement representation. The 12 bits for each axis are split into an MSB upper part (one byte containing bits 11 to 4) and an LSB lower part (one byte containing bits 3 to 0 of acceleration and a (ACC 0x02, 0x04, 0x06) *new_data* flag). Reading the acceleration data registers shall always start with the LSB part. In order to ensure the integrity of the acceleration data, the content of an MSB register is locked by reading the corresponding LSB register (shadowing procedure). When shadowing is enabled, the MSB must always be read in order to remove the data lock. The shadowing procedure can be disabled (enabled) by writing '1' ('0') to the bit *shadow_dis*. With shadowing disabled, the content of both MSB and LSB registers is updated by a new value immediately. Unused bits of the LSB registers may have any value and should be ignored. The (ACC 0x02, 0x04, 0x06) *new_data* flag of each LSB register is set if the data registers have been updated. The flag is reset if either the corresponding MSB or LSB part is read.

Two different streams of acceleration data are available, unfiltered and filtered. The unfiltered data is sampled with 2kHz. The sampling rate of the filtered data depends on the selected filter bandwidth and is always twice the selected bandwidth ($BW = ODR/2$). Which kind of data is stored in the acceleration data registers depends on bit (ACC 0x13) *data_high_bw*. If (ACC 0x13) *data_high_bw* is '0' ('1'), then filtered (unfiltered) data is stored in the registers. Both data streams are offset-compensated.

The bandwidth of filtered acceleration data is determined by setting the (ACC 0x10) *bw* bit as followed:

Table 7: Bandwidth configuration

bw	Bandwidth	Update Time t_{ut}
00xxx	*)	-
01000	7.81Hz	64ms
01001	15.63Hz	32ms
01010	31.25Hz	16ms
01011	62.5Hz	8ms
01100	125Hz	4ms
01101	250Hz	2ms
01110	500Hz	1ms
01111	1000Hz	0.5ms
1xxxx	*)	-

*) Note: Settings 00xxx result in a bandwidth of 7.81 Hz; settings 1xxxx result in a bandwidth of 1000 Hz. It is recommended to actively set an application specific and an appropriate bandwidth and to use the range from '01000b' to '01111b' only in order to be compatible with future products.

The accelerometer supports four different acceleration measurement ranges. A measurement range is selected by setting the (*ACC 0x0F*) range bits as follows:

Table 8: Range selection

Range	Acceleration measurement range	Resolution
0011	±2g	0.98mg/LSB
0101	±4g	1.95mg/LSB
1000	±8g	3.91mg/LSB
1100	±16g	7.81mg/LSB
others	reserved	-

5.2.2 Temperature Sensor

The width of temperature data is 8 bits given in two's complement representation. Temperature values are available in the (*ACC 0x08*) *temp* register.

The slope of the temperature sensor is 0.5K/LSB, its center temperature is 23°C [(*ACC 0x08*) *temp* = 0x00].

5.3 Self-test accelerometer

This feature permits to check the sensor functionality by applying electrostatic forces to the sensor core instead of external accelerations. By actually deflecting the seismic mass, the entire signal path of the sensor can be tested. Activating the self-test results in a static offset of the acceleration data; any external acceleration or gravitational force applied to the sensor during active self-test will be observed in the output as a superposition of both acceleration and self-test signal.

Before the self-test is enabled the g-range should be set to 8 g. The self-test is activated individually for each axis by writing the proper value to the (*ACC 0x32*) *self_test_axis* bits ('01b' for x-axis, '10b' for y-axis, '11b' for z-axis, '00b' to deactivate self-test). It is possible to control the direction of the deflection through bit (*ACC 0x32*) *self_test_sign*. The excitation occurs in negative (positive) direction if (*ACC 0x32*) *self_test_sign* = '0b' ('1b'). The amplitude of the deflection has to be set high by writing (*ACC 0x32*) *self_test_amp*='1b'. After the self-test is enabled, the user should wait 50ms before interpreting the acceleration data.

In order to ensure a proper interpretation of the self-test signal it is recommended to perform the self-test for both (positive and negative) directions and then to calculate the difference of the resulting acceleration values. Table 9 shows the minimum differences for each axis. The actually measured signal differences can be significantly larger.

Table 9: Self-test difference values

	x-axis signal	y-axis signal	z-axis signal
resulting minimum difference signal	800 mg	800 mg	400 mg

It is recommended to perform a reset of the device after a self-test has been performed. If the reset cannot be performed, the following sequence must be kept to prevent unwanted interrupt generation: disable interrupts, change parameters of interrupts, wait for at least 50ms, enable desired interrupts.



BOSCH

BMX055
Figure 5: Principle of offset compensation
Data sheet

Page 2

The public offset compensation registers (*ACC 0x38*) *offset_x*, (*ACC 0x39*) *offset_y*, (*ACC 0x3A*) *offset_z* are images of the corresponding registers in the NVM. With each image update (see section 5.5 Non-volatile memory accelerometer for details) the contents of the NVM registers are written to the public registers. The public registers can be over-written by the user at any time. After changing the contents of the public registers by either an image update or manually, all 8bit values are extended to 12bit values for internal computation. In the opposite direction, if an internally computed value changes it is converted to an 8bit value and stored in the public register.

Depending on the selected g-range the conversion from 12bit to 8bit values can result in a loss of accuracy of one to several LSB. This is shown in Figure 5.

In case an internally computed compensation value is too small or too large to fit into the corresponding register, it is saturated in order to prevent an overflow error.

By writing '1' to the (*ACC 0x36*) *offset_reset* bit, all offset compensation registers are reset to zero.

5.4.1 Fast compensation

Slow compensation is based on a 1st order high-pass filter, which continuously drives the average value of the output data stream of each axis to zero. The bandwidth of the high-pass filter is configured with bit (*ACC 0x37*) *cut_off* according to Table 10.

Table 10: Compensation period settings

(<i>ACC 0x37</i>) <i>cut_off</i>	high-pass filter bandwidth
0b	1
1b	10 Hz

The slow compensation can be enabled (disabled) for each axis independently by setting the bits (*ACC 0x36*) *hp_x_en*, *hp_y_en*, *hp_z_en* to '1' ('0'), respectively.

Slow compensation should not be used in combination with low-power mode. In low-power mode the conditions (availability of necessary data) for proper function of slow compensation are not fulfilled.

5.4.2 Fast compensation

Fast compensation is a one-shot process by which the compensation value is set in such a way that when added to the raw acceleration, the resulting acceleration value of each axis approaches the target value. This is best suited for "end-of-line trimming" with the customer's device positioned in a well-defined orientation. For fast compensation the g-range has to be switched to 2g.

The algorithm in detail: An average of 16 consecutive acceleration values is computed and the difference between target value and computed value is written to (*ACC 0x38*, *0x39*, *0x3A*) *offset_filt_x/y/z*. The public registers (*ACC 0x38*, *0x39*, *0x3A*) *offset_filt_x/y/z* are updated with the contents of the internal registers (using saturation if necessary) and can be read by the user.

Fast compensation is triggered for each axis individually by setting the (*ACC 0x36*) *cal_trigger* bits as shown in Table 11:

Table 11: Fast compensation axis selection

(ACC 0x36) <i>cal_trigger</i>	Selected Axis
00b	none
01b	x
10b	y
11b	z

Register (ACC 0x36) *cal_trigger* is a write-only register. Once triggered, the status of the fast correction process is reflected in the status bit (ACC 0x36) *cal_rdy*. Bit (ACC 0x36) *cal_rdy* is '0' while the correction is in progress. Otherwise it is '1'. Bit (ACC 0x36) *cal_rdy* is '0' when (ACC 0x36) *cal_trigger* is not '00'.

For the fast offset compensation, the compensation target can be chosen by setting the bits (ACC 0x37) *offset_target_x*, (ACC 0x37) *offset_target_y*, and (ACC 0x37) *offset_target_z* according to Table 12:

Table 12: Offset target settings

(ACC 0x37) <i>offset_target_x/y/z</i>	Target value
00b	0g
01b	+1g
10b	-1g
11b	0g

Fast compensation should not be used in combination with any of the low-power modes. In low-power mode the conditions (availability of necessary data) for proper function of fast compensation are not fulfilled.

5.4.3 Manual compensation

The contents of the public compensation registers (ACC 0x38, 0x39, 0x3A) *offset_filt_x/y/z* can be set manually via the digital interface. It is recommended to write into these registers directly after a new data interrupt has occurred in order not to disturb running offset computations.

Writing to the offset compensation registers is not allowed while the fast compensation procedure is running.

5.4.4 Inline calibration

For certain applications, it is often desirable to calibrate the offset once and to store the compensation values permanently. This can be achieved by using one of the aforementioned offset compensation methods to determine the proper compensation values and then storing these values permanently in the NVM. See section 5.5 Non-volatile memory accelerometer for details of the storing procedure.

Each time the device is reset, the compensation values are loaded from the non-volatile memory into the image registers and used for offset compensation. until they are possibly overwritten using one of the other compensation methods.

5.5 Non-volatile memory accelerometer

The entire memory of the accelerometer consists of three different kinds of registers: hard-wired, volatile, and non-volatile. Part of it can be both read and written by the user. Access to non-volatile memory is only possible through (volatile) image registers.

Altogether, there are eight registers (octets) with NVM backup which are accessible by the user. The addresses of the image registers range from (ACC 0x38) to (ACC 0x3C). While the addresses up to (ACC 0x3A) are used for offset compensation (see 5.4 Offset Compensation), addresses (ACC 0x3B) and (ACC 0x3C) are general purpose registers not linked to any sensor-specific functionality.

The content of the NVM is loaded to the image registers after a reset (either POR or softreset) or after a user request which is performed by writing '1' to the write-only bit (ACC 0x33) *nvm_load*. As long as the image update is in progress, bit (ACC 0x33) *nvm_rdy* is '0', otherwise it is '1'.

The image registers can be read and written like any other register.

Writing to the NVM is a three-step procedure:

1. Write the new contents to the image registers.
2. Write '1' to bit (ACC 0x33) *nvm_prog_mode* in order to unlock the NVM.
3. Write '1' to bit (ACC 0x33) *nvm_prog_trig* and keep '1' in bit (ACC 0x33) *nvm_prog_mode* in order to trigger the write process.

Writing to the NVM always renews the entire NVM contents. It is possible to check the write status by reading bit (ACC 0x33) *nvm_rdy*. While (ACC 0x33) *nvm_rdy* = '0', the write process is still in progress; if (ACC 0x33) *nvm_rdy* = '1', then writing is completed. As long as the write process is ongoing, no change of power mode and image registers is allowed. Also, the NVM write cycle must not be initiated while image registers are updated, in low-power mode, and in suspend mode.

Please note that the number of permitted NVM write-cycles is limited as specified in table 2. The number of remaining write-cycles can be obtained by reading bits (ACC 0x33) *nvm_remain*.

5.6 Interrupt controller accelerometer

The accelerometer is equipped with eight programmable interrupt engines. Each interrupt can be independently enabled and configured. If the trigger condition of an enabled interrupt is fulfilled, the corresponding status bit is set to '1' and the selected interrupt pin is activated. The accelerometer provides two interrupt pins, INT1 and INT2; interrupts can be freely mapped to any of these pins. The state of a specific interrupt pin is derived from a logic 'or' combination of all interrupts mapped to it.

The interrupt status registers are updated when a new data word is written into the acceleration data registers. If an interrupt is disabled, all active status bits associated with it are immediately reset.

5.6.1 General features

An interrupt is cleared depending on the selected interrupt mode, which is common to all interrupts. There are three different interrupt modes: non-latched, latched, and temporary. The mode is selected by the *(ACC 0x21) latch_int* bits according to Table 13.

Table 13: Interrupt mode selection

<i>(ACC 0x21) latch_int</i>	Interrupt mode
0000b	non-latched
0001b	temporary, 250ms
0010b	temporary, 500ms
0011b	temporary, 1s
0100b	temporary, 2s
0101b	temporary, 4s
0110b	temporary, 8s
0111b	latched
1000b	non-latched
1001b	temporary, 250µs
1010b	temporary, 500µs
1011b	temporary, 1ms
1100b	temporary, 12.5ms
1101b	temporary, 25ms
1110b	temporary, 50ms
1111b	latched

An interrupt is generated if its activation condition is met. It cannot be cleared as long as the activation condition is fulfilled. In the non-latched mode the interrupt status bit and the selected pin (the contribution to the 'or' condition for INT1 and/or INT2) are cleared as soon as the activation condition is no more valid. Exceptions to this behavior are the new data, orientation, and flat interrupts, which are automatically reset after a fixed time.

In latched mode an asserted interrupt status and the selected pin are cleared by writing '1' to bit *(ACC 0x21) reset_int*. If the activation condition still holds when it is cleared, the interrupt status is asserted again with the next change of the acceleration registers.

In the temporary mode an asserted interrupt and selected pin are cleared after a defined period of time. The behavior of the different interrupt modes is shown graphically in Figure 6. The timings in this mode are subject to the same tolerances as the bandwidths (see table 2).

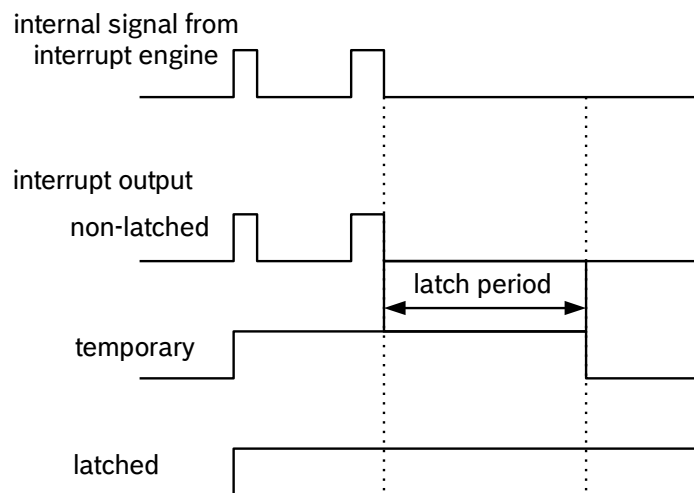

Figure 6: Interrupt modes

Several interrupt engines can use either unfiltered or filtered acceleration data as their input. For these interrupts, the source can be selected with the bits in register (ACC 0x1E). These are (ACC 0x1E) *int_src_data*, (ACC 0x1E) *int_src_tap*, (ACC 0x1E) *int_src_slo_no_mot*, (ACC 0x1E) *int_src_slope*, (ACC 0x1E) *int_src_high*, and (ACC 0x1E) *int_src_low*. Setting the respective bits to '0' ('1') selects filtered (unfiltered) data as input. The orientation recognition and flat detection interrupt always use filtered input data.

It is strongly recommended to set interrupt parameters prior to enabling the interrupt. Changing parameters of an already enabled interrupt may cause unwanted interrupt generation and generation of a false interrupt history. A safe way to change parameters of an enabled interrupt is to keep the following sequence: disable the desired interrupt, change parameters, wait for at least 10ms, and then re-enable the desired interrupt.

5.6.2 Mapping to physical interrupt pins (inttype to INT Pin#)

Registers (ACC 0x19) to (ACC 0x1B) are dedicated to mapping of interrupts to the interrupt pins "INT1" or "INT2". Setting (ACC 0x19) *int1_"inttype"* to '1' ('0') maps (unmaps) "inttype" to pin "INT1". Correspondingly setting (ACC 0x1B) *int2_"inttype"* to '1' ('0') maps (unmaps) "inttype" to pin "INT2".

Note: "inttype" to be replaced with the precise notation, given in the memory map in chapter 6.

Example: For flat interrupt (*int1_flat*): Setting (ACC 0x19) *int1_flat* to '1' maps *int1_flat* to pin "INT1".

5.6.3 Electrical behavior (INT pin# to open-drive or push-pull)

Both interrupt pins can be configured to show the desired electrical behavior. The 'active' level of each interrupt pin is determined by the (ACC 0x20) *int1_lvl* and (ACC 0x20) *int2_lvl* bits.

If (ACC 0x20) *int1_lvl* = '1' ('0') / (ACC 0x20) *int2_lvl* = '1' ('0'), then pin "INT1" / pin "INT2" is active '1' ('0'). The characteristic of the output driver of the interrupt pins may be configured with bits (ACC 0x20) *int1_od* and (ACC 0x20) *int2_od*. By setting bits (ACC 0x20) *int1_od* / (ACC 0x20) *int2_od* to '1', the output driver shows open-drive characteristic, by setting the configuration bits to '0', the output driver shows push-pull characteristic. When open-drive characteristic is selected in the design, external pull-up or pull-down resistor should be applied

according to the `int_lvl` configuration. When open-drive characteristic is selected in the design, external pull-up or pull-down resistor should be applied according to the `int_lvl` configuration.

5.6.4 New data interrupt

This interrupt serves for synchronous reading of acceleration data. It is generated after storing a new value of z-axis acceleration data in the data register. The interrupt is cleared automatically when the next data acquisition cycle starts. The interrupt status is '0' for at least 50µs.

The interrupt mode of the new data interrupt is fixed to non-latched.

It is enabled (disabled) by writing '1' ('0') to bit (`ACC 0x17`) `data_en`. The interrupt status is stored in bit (`ACC 0x0A`) `data_int`.

Due to the settling time of the filter, the first interrupt after wake-up from suspend or standby mode will take longer than the update time.

5.6.5 Slope / any-motion detection

Slope / any-motion detection uses the slope between successive acceleration signals to detect changes in motion. An interrupt is generated when the slope (absolute value of acceleration difference) exceeds a preset threshold. It is cleared as soon as the slope falls below the threshold. The principle is made clear in Figure 7.

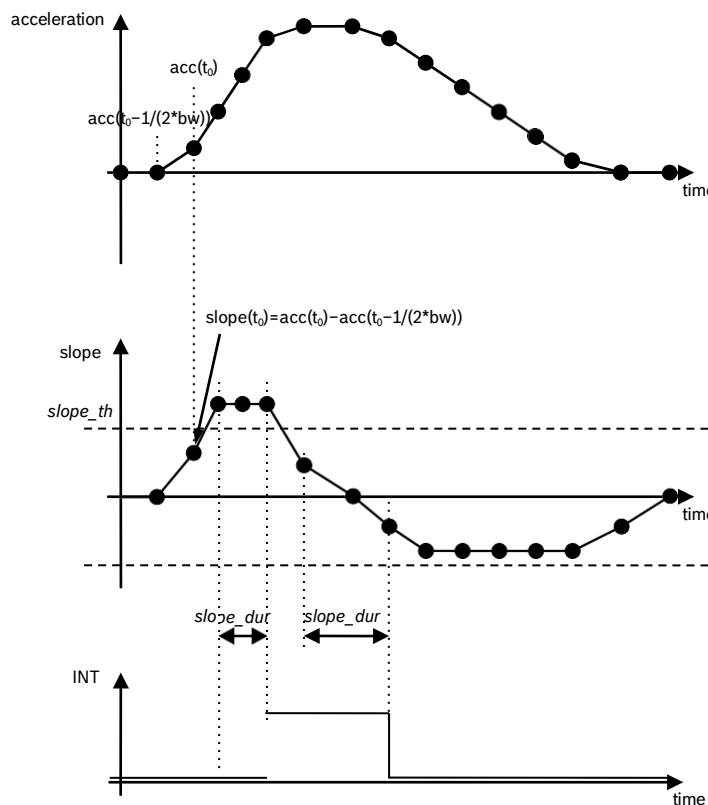

Figure 7: Principle of any-motion detection

The threshold is defined through register (ACC 0x28) *slope_th*. In terms of scaling 1 LSB of (ACC 0x28) *slope_th* corresponds to 3.91 mg in 2g-range (7.81 mg in 4g-range, 15.6 mg in 8g-range and 31.3 mg in 16g-range). Therefore the maximum value is 996 mg in 2g-range (1.99g in 4g-range, 3.98g in 8g-range and 7.97g in 16g-range).

The time difference between the successive acceleration signals depends on the selected bandwidth and equates to $1/(2 \cdot \text{bandwidth})$ ($t=1/(2 \cdot \text{bw})$). In order to suppress false triggers, the interrupt is only generated (cleared) if a certain number N of consecutive slope data points is larger (smaller) than the slope threshold given by (ACC 0x28) *slope_th*. This number is set by the (ACC 0x27) *slope_dur* bits. It is $N = (\text{ACC } 0x27) \text{ slope_dur} + 1$ for (ACC 0x27).

Example: (ACC 0x27) *slope_dur* = 00b, ..., 11b = 1decimal, ..., 4decimal.

5.6.5.1 Enabling (disabling) for each axis

Any-motion detection can be enabled (disabled) for each axis separately by writing '1' ('0') to bits (ACC 0x16) *slope_en_x*, (ACC 0x16) *slope_en_y*, (ACC 0x16) *slope_en_z*. The criteria for any-motion detection are fulfilled and the slope interrupt is generated if the slope of any of the enabled axes exceeds the threshold (ACC 0x28) *slope_th* for [(ACC 0x27) *slope_dur* + 1] consecutive times. As soon as the slopes of all enabled axes fall or stay below this threshold for [(ACC 0x27) *slope_dur* + 1] consecutive times the interrupt is cleared unless interrupt signal is latched.

5.6.5.2 Axis and sign information of slope / any motion interrupt

The interrupt status is stored in bit (ACC 0x09) *slope_int*. The any-motion interrupt supplies additional information about the detected slope. The axis which triggered the interrupt is given by that one of bits (ACC 0x0B) *slope_first_x*, (ACC 0x0B) *slope_first_y*, (ACC 0x0B) *slope_first_z* that contains a value of '1'. The sign of the triggering slope is held in bit (ACC 0x0B) *slope_sign* until the interrupt is retriggered. If (ACC 0x0B) *slope_sign* = '0' ('1'), the sign is positive (negative).

5.6.6 Tap sensing

Tap sensing has a functional similarity with a common laptop touch-pad or clicking keys of a computer mouse. A tap event is detected if a pre-defined slope of the acceleration of at least one axis is exceeded. Two different tap events are distinguished: A 'single tap' is a single event within a certain time, followed by a certain quiet time. A 'double tap' consists of a first such event followed by a second event within a defined time frame.

Single tap interrupt is enabled (disabled) by writing '1' ('0') to bit (ACC 0x16) *s_tap_en*. Double tap interrupt is enabled (disabled) by writing '1' ('0') to bit (ACC 0x16) *d_tap_en*.

The status of the single tap interrupt is stored in bit (ACC 0x09) *s_tap_int*, the status of the double tap interrupt is stored in bit (ACC 0x09) *d_tap_int*.

The slope threshold for detecting a tap event is set by bits (ACC 0x2B) *tap_th*. The meaning of (ACC 0x2B) *tap_th* depends on the range setting. 1 LSB of (ACC 0x2B) *tap_th* corresponds to a slope of 62.5mg in 2g-range, 125mg in 4g-range, 250mg in 8g-range, and 500mg in 16g-range.

In Figure 8 the meaning of the different timing parameters is visualized:

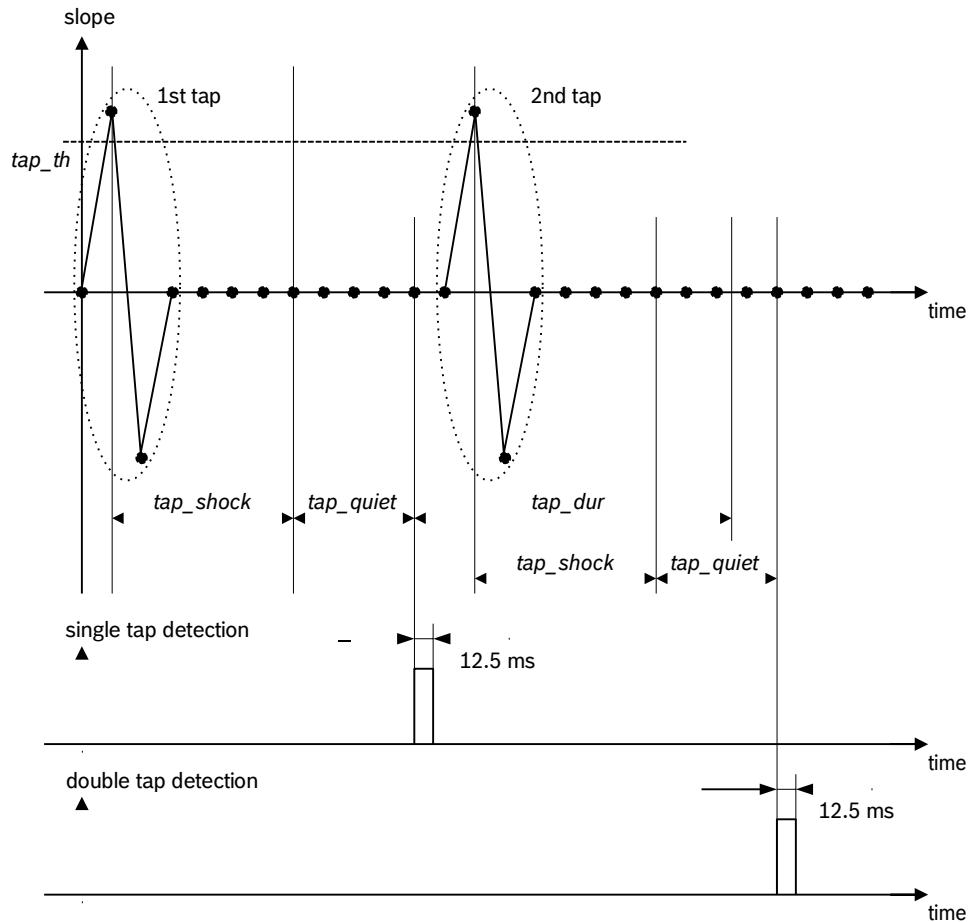

Figure 8: Timing of tap detection

The parameters (ACC 0x2A) *tap_shock* and (ACC 0x2A) *tap_quiet* apply to both single tap and double tap detection, while (ACC 0x2A) *tap_dur* applies to double tap detection only. Within the duration of (ACC 0x2A) *tap_shock* any slope exceeding (ACC 0x2B) *tap_th* after the first event is ignored. Contrary to this, within the duration of (ACC 0x2A) *tap_quiet* no slope exceeding (ACC 0x2B) *tap_th* must occur, otherwise the first event will be cancelled.

5.6.6.1 Single tap detection

A single tap is detected and the single tap interrupt is generated after the combined durations of (ACC 0x2A) *tap_shock* and (ACC 0x2A) *tap_quiet*, if the corresponding slope conditions are fulfilled. The interrupt is cleared after a delay of 12.5 ms.

Do not map single-tap to any INT pin if you do not want to use it.

5.6.6.2 Double tap detection

A double tap interrupt is generated if an event fulfilling the conditions for a single tap occurs within the set duration in (ACC 0x2A) *tap_dur* after the completion of the first tap event. The interrupt is automatically cleared after a delay of 12.5 ms.

5.6.6.3 Selecting the timing of tap detection

For each of parameters (ACC 0x2A) *tap_shock* and (ACC 0x2A) *tap_quiet* two values are selectable. By writing '0' ('1') to bit (ACC 0x2A) *tap_shock* the duration of (ACC 0x2A) *tap_shock* is set to 50 ms (75 ms). By writing '0' ('1') to bit (ACC 0x2A) *tap_quiet* the duration of (ACC 0x2A) *tap_quiet* is set to 30 ms (20 ms).

The length of (ACC 0x2A) *tap_dur* can be selected by setting the (ACC 0x2A) *tap_dur* bits according to Table 14:

Table 14: Selection of *tap_dur*

(ACC 0x2A) <i>tap_dur</i>	length of <i>tap_dur</i>
000b	50 ms
001b	100 ms
010b	150 ms
011b	200 ms
100b	250 ms
101b	375 ms
110b	500 ms
111b	700 ms

5.6.6.4 Axis and sign information of tap sensing

The sign of the slope of the first tap which triggered the interrupt is stored in bit (ACC 0x0B) *tap_sign* ('0' means positive sign, '1' means negative sign). The value of this bit persists after clearing the interrupt.

The axis which triggered the interrupt is indicated by bits (ACC 0x0B) *tap_first_x*, (ACC 0x0B) *tap_first_y*, and (ACC 0x0B) *tap_first_z*.

The bit corresponding to the triggering axis contains a '1' while the other bits hold a '0'. These bits are cleared together with clearing the interrupt status.

5.6.6.5 Tap sensing in low power mode

In low-power mode, a limited number of samples is processed after wake-up to decide whether an interrupt condition is fulfilled. The number of samples is selected by bits (ACC 0x2B) *tap_samp* according to Table 15.

Table 15: Meaning of (ACC 0x2B) *tap_samp*

(ACC 0x2B) <i>tap_samp</i>	Number of Samples
00b	2
01b	4
10b	8
11b	16

5.6.7 Orientation recognition

The orientation recognition feature informs on an orientation change of the sensor with respect to the gravitational field vector 'g'. The measured acceleration vector components with respect to the gravitational field are defined as shown in Figure 9.

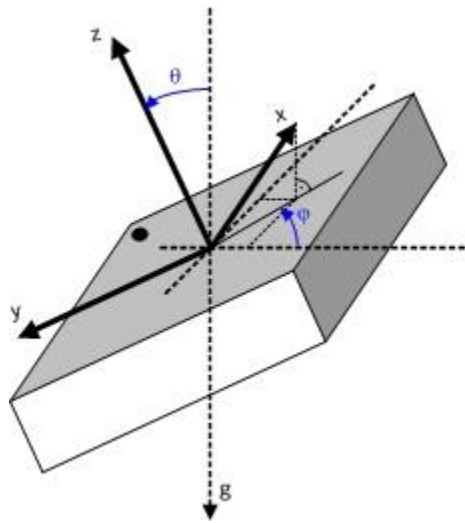

Figure 9: Definition of vector components

Therefore, the magnitudes of the acceleration vectors are calculated as follows:

$$\begin{aligned} \text{acc_x} &= 1g \times \sin\theta \times \cos\varphi \\ \text{acc_y} &= -1g \times \sin\theta \times \sin\varphi \\ \text{acc_z} &= 1g \times \cos\theta \\ \text{acc_y/acc_x} &= -\tan\varphi \end{aligned}$$

Depending on the magnitudes of the acceleration vectors the orientation of the device in the space is determined and stored in the three (*ACC 0x0C*) *orient* bits. These bits may not be reset in the sleep phase of low-power mode. There are three orientation calculation modes with different thresholds for switching between different orientations: symmetrical, high- asymmetrical, and low-asymmetrical. The mode is selected by setting the (*ACC 0x2C*) *orient_mode* bits as given in Table 16.

Table 16: Orientation mode settings

<i>(ACC 0x2C) orient_mode</i>	Orientation Mode
00b	symmetrical
01b	high-asymmetrical
10b	low-asymmetrical
11b	symmetrical

For each orientation mode the (*ACC 0x0C*) *orient* bits have a different meaning as shown in Table 17 to Table 19:

Table 17: Meaning of the (ACC 0x0C) orient bits in symmetrical mode

(ACC 0x0C) orient	Name	Angle	Condition
x00	portrait upright	$315^\circ < \varphi < 45^\circ$	$ \text{acc_y} < \text{acc_x} - \text{'hyst'}$ and $\text{acc_x} - \text{'hyst'} \geq 0$
x01	portrait upside down	$135^\circ < \varphi < 225^\circ$	$ \text{acc_y} < \text{acc_x} - \text{'hyst'}$ and $\text{acc_x} + \text{'hyst'} < 0$
x10	landscape left	$45^\circ < \varphi < 135^\circ$	$ \text{acc_y} \geq \text{acc_x} + \text{'hyst'}$ and $\text{acc_y} < 0$
x11	landscape right	$225^\circ < \varphi < 315^\circ$	$ \text{acc_y} \geq \text{acc_x} + \text{'hyst'}$ and $\text{acc_y} \geq 0$

Table 18: Meaning of the (ACC 0x0C) orient bits in high-asymmetrical mode

(ACC 0x0C) orient	Name	Angle	Condition
x00	portrait upright	$297^\circ < \varphi < 63^\circ$	$ \text{acc_y} < 2 \cdot \text{acc_x} - \text{'hyst'}$ and $\text{acc_x} - \text{'hyst'} \geq 0$
x01	portrait upside down	$117^\circ < \varphi < 243^\circ$	$ \text{acc_y} < 2 \cdot \text{acc_x} - \text{'hyst'}$ and $\text{acc_x} + \text{'hyst'} < 0$
x10	landscape left	$63^\circ < \varphi < 117^\circ$	$ \text{acc_y} \geq 2 \cdot \text{acc_x} + \text{'hyst'}$ and $\text{acc_y} < 0$
x11	landscape right	$243^\circ < \varphi < 297^\circ$	$ \text{acc_y} \geq 2 \cdot \text{acc_x} + \text{'hyst'}$ and $\text{acc_y} \geq 0$

Table 19: Meaning of the (ACC 0x0C) orient bits in low-asymmetrical mode

(ACC 0x0C) orient	Name	Angle	Condition
x00	portrait upright	$333^\circ < \varphi < 27^\circ$	$ \text{acc_y} < 0.5 \cdot \text{acc_x} - \text{'hyst'}$ and $\text{acc_x} - \text{'hyst'} \geq 0$
x01	portrait upside down	$153^\circ < \varphi < 207^\circ$	$ \text{acc_y} < 0.5 \cdot \text{acc_x} - \text{'hyst'}$ and $\text{acc_x} + \text{'hyst'} < 0$
x10	landscape left	$27^\circ < \varphi < 153^\circ$	$ \text{acc_y} \geq 0.5 \cdot \text{acc_x} + \text{'hyst'}$ and $\text{acc_y} < 0$
x11	landscape right	$207^\circ < \varphi < 333^\circ$	$ \text{acc_y} \geq 0.5 \cdot \text{acc_x} + \text{'hyst'}$ and $\text{acc_y} \geq 0$

In the preceding tables, the parameter 'hyst' stands for a hysteresis, which can be selected by setting the (ACC 0x2C) orient_hyst bits. 1 LSB of (ACC 0x2C) orient_hyst always corresponds to 62.5 mg, in any g-range (i.e. increment is independent from g-range setting). It is important to note that by using a hysteresis $\neq 0$ the actual switching angles become different from the angles given in the tables since there is an overlap between the different orientations.

The most significant bit of the (ACC 0x0C) orient bits (which is displayed as an 'x' in the above given tables) contains information about the direction of the z-axis. It is set to '0' ('1') if $\text{acc_z} \geq 0$ ($\text{acc_z} < 0$).

Figure 10 shows the typical switching conditions between the four different orientations for the symmetrical mode i.e. without hysteresis:

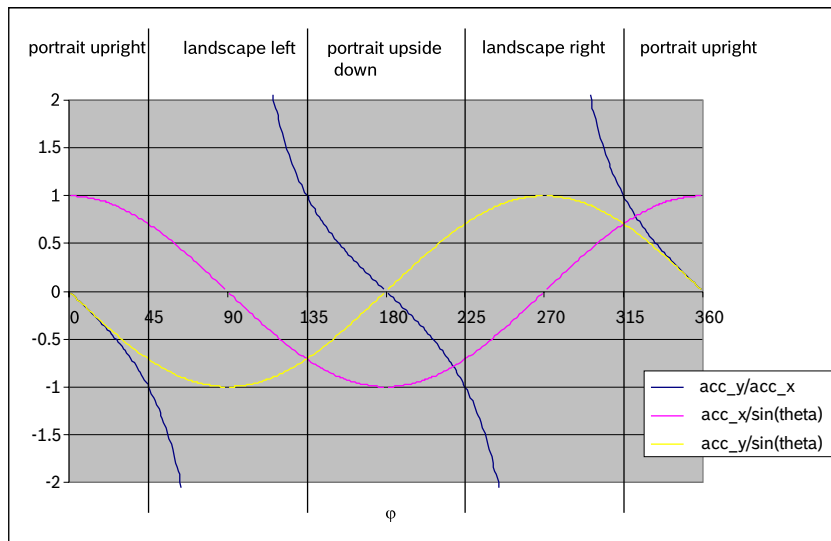

Figure 10: Typical orientation switching conditions w/o hysteresis

The orientation interrupt is enabled (disabled) by writing '1' ('0') to bit (*ACC 0x16*) *orient_en*. The interrupt is generated if the value of (*ACC 0x0C*) *orient* has changed. It is automatically cleared after one stable period of the (*ACC 0x0C*) *orient* value. The interrupt status is stored in the (*ACC 0x09*) *orient_int* bit. The register (*ACC 0x0C*) *orient* always reflects the current orientation of the device, irrespective of which interrupt mode has been selected. Bit (*ACC 0x0C*) *orient*<2> reflects the device orientation with respect to the z-axis. The bits (*ACC 0x0C*) *orient*<1:0> reflect the device orientation in the x-y-plane. The conventions associated with register (*ACC 0x0C*) *orient* are detailed in chapter 6.

5.6.7.1 Orientation blocking

The change of the (*ACC 0x0C*) *orient* value and – as a consequence – the generation of the interrupt can be blocked according to conditions selected by setting the value of the (*ACC 0x2C*) *orient_blocking* bits as described by Table 20.

Table 20: Blocking conditions for orientation recognition

(<i>ACC 0x2C</i>) <i>orient_blocking</i>	Conditions
00b	no blocking
01b	theta blocking or acceleration in any axis > 1.5g
10b	theta blocking or acceleration slope in any axis > 0.2 g or acceleration in any axis > 1.5g
11b	theta blocking or acceleration slope in any axis > 0.4 g or acceleration in any axis > 1.5g and value of orient is not stable for at least 100 ms

The theta blocking is defined by the following inequality:

$$|\tan \theta| < \frac{\sqrt{\text{blocking_theta}}}{8}$$

The parameter *blocking_theta* of the above given equation stands for the contents of the (ACC 0x2D) *orient_theta* bits. It is possible to define a blocking angle between 0° and 44.8°. The internal blocking algorithm saturates the acceleration values before further processing. As a consequence, the blocking angles are strictly valid only for a device at rest; they can be different if the device is moved.

Example:

To get a maximum blocking angle of 19° the parameter *blocking_theta* is determined in the following way: $(8 * \tan(19^\circ))^2 = 7.588$, therefore, *blocking_value* = 8dec = 001000b has to be chosen.

In order to avoid unwanted generation of the orientation interrupt in a nearly flat position ($z \sim 0$, sign change due to small movements or noise), a hysteresis of 0.2 g is implemented for the z-axis, i. e. a after a sign change the interrupt is only generated after $|z| > 0.2$ g.

5.6.7.2 Up-Down Interrupt Suppression Flag

Per default an orientation interrupt is triggered when any of the bits in register (ACC 0x0C) *orient* changes state. The accelerometer can be configured to trigger orientation interrupts only when the device position changes in the x-y-plane while orientation changes with respect to the z-axis are ignored. A change of the orientation of the z-axis, and hence a state change of bit (ACC 0x0C) *orient<2>* is ignored (considered) when bit (ACC 0x2D) *orient_ud_en* is set to '0' ('1').

5.6.8 Flat detection

The flat detection feature gives information about the orientation of the devices' z-axis relative to the g-vector, i. e. it recognizes whether the device is in a flat position or not.

The flat angle Θ is adjustable by (0x2E) *flat_theta* from 0° to 44.8°. The flat angle can be set according to following formula:

$$\Theta = \text{atan}\left(\frac{1}{8} \sqrt{\text{flat_theta}}\right)$$

A hysteresis of the flat detection can be enabled by (0x2F) *flat_hy* bits. In this case the flat position is set if the angle drops below following threshold:

$$\Theta_{\text{hyst},l} = \text{atan}\left(\frac{1}{8} \sqrt{\text{flat_theta} \cdot \left(1 - \frac{\text{flat_hy}}{1024}\right) - \frac{\text{flat_hy}}{16}}\right)$$

The flat position is reset if the angle exceeds the following threshold:

$$\Theta_{hyst,ul} = \text{atan} \left(\frac{1}{8} \sqrt{|\text{flat_theta}| \left(1 + \frac{\text{flat_hy}}{1024} \right) + \frac{\text{flat_hy}}{16}} \right)$$

The flat interrupt is enabled (disabled) by writing '1' ('0') to bit (*ACC 0x16*) *flat_en*. The flat value is stored in the (*ACC 0x0C*) *flat* bit if the interrupt is enabled. This value is '1' if the device is in the flat position, it is '0' otherwise. The flat interrupt is generated if the flat value has changed and the new value is stable for at least the time given by the (*ACC 0x2F*) *flat_hold_time* bits. A flat interrupt may be also generated if the flat interrupt is enabled. The actual status of the interrupt is stored in the (*ACC 0x09*) *flat_int* bit. The flat orientation of the sensor can always be determined from reading the (*ACC 0x0C*) *flat* bit after interrupt generation. If unlatched interrupt mode is used, the (*ACC 0x09*) *flat_int* value and hence the interrupt is automatically cleared after one sample period. If temporary or latched interrupt mode is used, the (*ACC 0x09*) *flat_int* value is kept fixed until the latch time expires or the interrupt is reset.

The meaning of the (*ACC 0x2F*) *flat_hold_time* bits can be seen from Table 21.

Table 21: Meaning of *flat_hold_time*

(<i>ACC 0x2F</i>) <i>flat_hold_time</i>	Time
00b	0
01b	512 ms
10b	1024 ms
11b	2048 ms

5.6.9 Low-g interrupt

This interrupt is based on the comparison of acceleration data against a low-g threshold, which is most useful for free-fall detection.

The interrupt is enabled (disabled) by writing '1' ('0') to the (*ACC 0x17*) *low_en* bit. There are two modes available, 'single' mode and 'sum' mode. In 'single' mode, the acceleration of each axis is compared with the threshold; in 'sum' mode, the sum of absolute values of all accelerations $|acc_x| + |acc_y| + |acc_z|$ is compared with the threshold. The mode is selected by the contents of the (*ACC 0x24*) *low_mode* bit: '0' means 'single' mode, '1' means 'sum' mode.

The low-g threshold is set through the (*ACC 0x23*) *low_th* register. 1 LSB of (*ACC 0x23*) *low_th* always corresponds to an acceleration of 7.81 mg (i.e. increment is independent from g-range setting).

A hysteresis can be selected by setting the (*ACC 0x24*) *low_hy* bits. 1 LSB of (*ACC 0x24*) *low_hy* always corresponds to an acceleration difference of 125 mg in any g-range (as well, increment is independent from g-range setting).

The low-g interrupt is generated if the absolute values of the acceleration of all axes ('and' relation, in case of single mode) or their sum (in case of sum mode) are lower than the threshold for at least the time defined by the (*ACC 0x22*) *low_dur* register. The interrupt is reset

if the absolute value of the acceleration of at least one axis ('or' relation, in case of single mode) or the sum of absolute values (in case of sum mode) is higher than the threshold plus the hysteresis for at least one data acquisition. In bit (*ACC 0x09*) *low_int* the interrupt status is stored.

The relation between the content of (*ACC 0x22*) *low_dur* and the actual delay of the interrupt generation is: $\text{delay [ms]} = [(\text{ACC } 0x22) \text{ low_dur} + 1] \cdot 2 \text{ ms}$. Therefore, possible delay times range from 2 ms to 512 ms.

5.6.10 High-g interrupt

This interrupt is based on the comparison of acceleration data against a high-g threshold for the detection of shock or other high-acceleration events.

The high-g interrupt is enabled (disabled) per axis by writing '1' ('0') to bits (*ACC 0x17*) *high_en_x*, (*ACC 0x17*) *high_en_y*, and (*ACC 0x17*) *high_en_z*, respectively. The high-g threshold is set through the (*ACC 0x26*) *high_th* register. The meaning of an LSB of (*ACC 0x26*) *high_th* depends on the selected g-range: it corresponds to 7.81 mg in 2g-range, 15.63 mg in 4g-range, 31.25 mg in 8g-range, and 62.5 mg in 16g-range (i.e. increment depends from g-range setting).

A hysteresis can be selected by setting the (*ACC 0x24*) *high_hy* bits. Analogously to (*ACC 0x26*) *high_th*, the meaning of an LSB of (*ACC 0x24*) *high_hy* is g-range dependent: It corresponds to an acceleration difference of 125 mg in 2g-range, 250 mg in 4g-range, 500 mg in 8g-range, and 1000mg in 16g-range (as well, increment depends from g-range setting).

The high-g interrupt is generated if the absolute value of the acceleration of at least one of the enabled axes ('or' relation) is higher than the threshold for at least the time defined by the (*ACC 0x25*) *high_dur* register. The interrupt is reset if the absolute value of the acceleration of all enabled axes ('and' relation) is lower than the threshold minus the hysteresis for at least the time defined by the (*ACC 0x25*) *high_dur* register. In bit (*ACC 0x09*) *high_int* the interrupt status is stored. The relation between the content of (*ACC 0x25*) *high_dur* and the actual delay of the interrupt generation is $\text{delay [ms]} = [(\text{ACC } 0x22) \text{ low_dur} + 1] \cdot 2 \text{ ms}$. Therefore, possible delay times range from 2 ms to 512 ms. The interrupt will be cleared immediately once acceleration is lower than threshold.

5.6.10.1 Axis and sign information of high-g interrupt

The axis which triggered the interrupt is indicated by bits (*ACC 0x0C*) *high_first_x*, (*ACC 0x0C*) *high_first_y*, and (*ACC 0x0C*) *high_first_z*. The bit corresponding to the triggering axis contains a '1' while the other bits hold a '0'. These bits are cleared together with clearing the interrupt status. The sign of the triggering acceleration is stored in bit (*ACC 0x0C*) *high_sign*. If (*ACC 0x0C*) *high_sign* = '0' ('1'), the sign is positive (negative).

5.6.11 No-motion / slow motion detection

The slow-motion/no-motion interrupt engine can be configured in two modes.

In slow-motion mode an interrupt is triggered when the measured slope of at least one enabled axis exceeds the programmable slope threshold for a programmable number of samples. Hence the engine behaves similar to the any-motion interrupt, but with a different set of parameters. In order to suppress false triggers, the interrupt is only generated (cleared) if a certain number *N* of consecutive slope data points is larger (smaller) than the slope threshold given by (*ACC 0x27*) *slo_no_mot_dur<1:0>*. The number is $N = (\text{ACC } 0x27)$

slo_no_mot_dur<1:0> + 1.

In no-motion mode an interrupt is generated if the slope on all selected axes remains smaller than a programmable threshold for a programmable delay time. Figure 11 shows the timing diagram for the no-motion interrupt. The scaling of the threshold value is identical to that of the slow-motion interrupt. However, in no-motion mode register (ACC 0x27) *slo_no_mot_dur* defines the delay time before the no-motion interrupt is triggered. Table 22 lists the delay times adjustable with register (ACC 0x27) *slo_no_mot_dur*. The timer tick period is 1 second. Hence using short delay times can result in considerable timing uncertainty.

If bit (ACC 0x18) *slo_no_mot_sel* is set to '1' ('0') the no-motion/slow-motion interrupt engine is configured in the no-motion (slow-motion) mode. Common to both modes, the engine monitors the slopes of the axes that have been enabled with bits (ACC 0x18) *slo_no_mot_en_x*, (ACC 0x18) *slo_no_mot_en_y*, and (ACC 0x18) *slo_no_mot_en_z* for the x-axis, y-axis and z-axis, respectively. The measured slope values are continuously compared against the threshold value defined in register (ACC 0x29) *slo_no_mot_th*. The scaling is such that 1 LSB of (ACC 0x29) *slo_no_mot_th* corresponds to 3.91 mg in 2g-range (7.81 mg in 4g-range, 15.6 mg in 8g-range and 31.3 mg in 16g-range). Therefore the maximum value is 996 mg in 2g-range (1.99g in 4g-range, 3.98g in 8g-range and 7.97g in 16g-range). The time difference between the successive acceleration samples depends on the selected bandwidth and equates to $1/(2 * bw)$.

Table 22: No-motion time-out periods

(ACC 0x27) <i>slo_no_mot_dur</i>	Delay time	(ACC 0x27) <i>slo_no_mot_dur</i>	Delay time	(ACC 0x27) <i>slo_no_mot_dur</i>	Delay Time
0	1 s	16	40 s	32	88 s
1	2 s	17	48 s	33	96 s
2	3 s	18	56 s	34	104 s
...	...	19	64 s
14	15 s	20	72 s	62	328 s
15	16 s	21	80 s	63	336 s

Note: *slo_no_mot_dur* values 22 to 31 are not specified

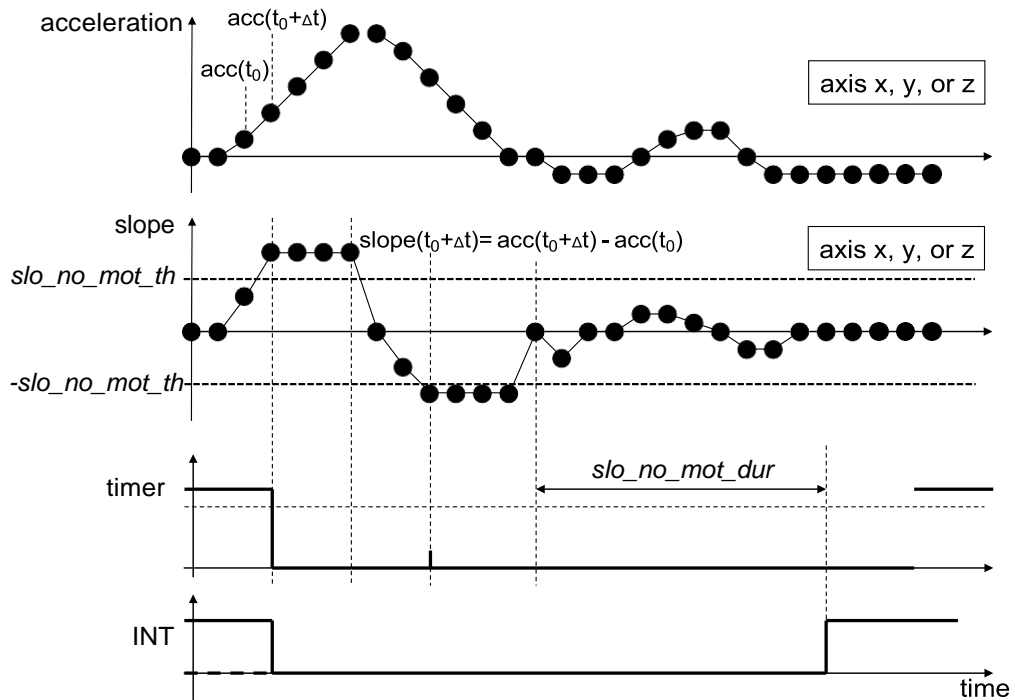

Figure 11: Timing of no-motion interrupt

5.7 Softreset accelerometer

A softreset causes all user configuration settings to be overwritten with their default value and the sensor to enter normal mode.

A softreset is initiated by means of writing value '0xB6' to register (ACC 0x14) *softrset*. Subsequently a waiting time of $t_{w,up1}$ (max.) is required prior to accessing any configuration register.

6 Register description accelerometer

6.1 General remarks accelerometer

The entire communication with the device is performed by reading from and writing to registers. Registers have a width of 8 bits; they are mapped to a common space of 64 addresses from (*ACC 0x00*) up to (*ACC 0x3F*). Within the used range there are several registers which are either completely or partially marked as 'reserved'. Any reserved bit is ignored when it is written and no specific value is guaranteed when read. It is recommended not to use registers at all which are completely marked as 'reserved'. Furthermore it is recommended to mask out (logical *and* with zero) reserved bits of registers which are partially marked as reserved.

Registers with addresses from (*ACC 0x00*) up to (*ACC 0x0E*) are read-only. Any attempt to write to these registers is ignored. There are bits within some registers that trigger internal sequences. These bits are configured for write-only access, e. g. (*ACC 0x21*) *reset_int* or the entire (*ACC 0x14*) *softreset* register, and read as value '0'.

6.2 Register map accelerometer

Register Address	bit7	bit6	bit5	bit4	bit3	bit2	bit1	bit0	Access	Default		
0x3F	fifo_data_output_register<7:0>								ro	0x00		
0x3E	fifo_mode<1:0>				fifo_data_select<1:0>				w/r	0x00		
0x3D									w/r	0xFF		
0x3C	GP1<7:0>								w/r	0x00		
0x3B	GP0<7:0>								w/r	0x00		
0x3A	offset_z<7:0>								w/r	0x00		
0x39	offset_y<7:0>								w/r	0x00		
0x38	offset_x<7:0>								w/r	0x00		
0x37	offset_target_z<1:0>		offset_target_y<1:0>		offset_target_x<1:0>		cut_off		w/r	0x00		
0x36	offset_reset	cal_trigger<1:0>		cal_rdy	hp_z_en		hp_y_en	hp_x_en	w/r	0x10		
0x35									w/r	0x00		
0x34									w/r	0x00		
0x33	nvm_remain<3:0>			nvm_load		nvm_rdy	nvm_prog_trig	nvm_prog_mode	w/r	0xF0		
0x32				self_test_amp	self_test_sign		self_test_axis<1:0>		w/r	0x00		
0x31									w/r	0xFF		
0x30	fifo_water_mark_level_trigger_retain<5:0>								w/r	0x00		
0x2F	flat_hold_time<1:0>				flat_theta<5:0>		flat_hy<2:0>		w/r	0x11		
0x2E									w/r	0x08		
0x2D	orient_ud_en		orient_theta<5:0>				orient_mode<1:0>		w/r	0x48		
0x2C	orient_hyst<2:0>			orient_blocking<1:0>		orient_mode<1:0>				w/r	0x18	
0x2B	tap_samp<1:0>		tap_th<4:0>			tap_dur<2:0>				w/r	0x0A	
0x2A	tap_quiet	tap_shock									w/r	0x04
0x29	slo_no_mot_th<7:0>								w/r	0x14		
0x28	slope_th<7:0>								w/r	0x14		
0x27	slo_no_mot_dur<5:0>				slope_dur<1:0>						w/r	0x00
0x26	high_th<7:0>								w/r	0xC0		
0x25	high_dur<7:0>								w/r	0x0F		
0x24	high_hy<1:0>		low_mode		low_hy<1:0>						w/r	0x81
0x23	low_th<7:0>								w/r	0x30		
0x22	low_dur<7:0>								w/r	0x09		
0x21	reset_int					latch_int<3:0>				w/r	0x00	
0x20					int2_od	int2_lv1	int1_od	int1_lv1	w/r	0x05		
0x1F									w/r	0xFF		
0x1E	int_src_data		int_src_tap	int_src_slo_no_mot	int_src_slope	int_src_high	int_src_low			w/r	0x00	
0x1D									w/r	0xFF		
0x1C									w/r	0xFF		
0x1B	int2_flat	int2_orient	int2_s_tap	int2_d_tap	int2_slo_no_mot	int2_slope	int2_high	int2_low	w/r	0x00		
0x1A	int2_data	int2_fwm	int2_full	int1_full		int1_fwm	int1_data			w/r	0x00	
0x19	int1_flat	int1_orient	int1_s_tap	int1_d_tap	int1_slo_no_mot	int1_slope	int1_high	int1_low	w/r	0x00		
0x18			slo_no_mot_sel		slo_no_mot_en_z	slo_no_mot_en_y	slo_no_mot_en_x			w/r	0x00	
0x17	flat_en	orient_en	s_tap_en	d_tap_en	low_en	high_en_z	high_en_y	high_en_x	w/r	0x00		
0x16			slope_en_z		slope_en_y	slope_en_x			w/r	0x00		
0x15									w/r	0xFF		
0x14	softreset								wo	0x00		
0x13	data_high_bw	shadow_dis	sleep_timer_mode		sleep_dur<3:0>				w/r	0x00		
0x12	lowpower_mode	deep_suspend			bw<4:0>				w/r	0x0F		
0x11	suspend	lowpower_en			range<3:0>				w/r	0x03		
0x10									w/r	0x00		
0x0F	fifo_overrun		fifo_frame_counter<6:0>						ro	0x00		
0x0D									w/r	0xFF		
0x0C	flat	orient<2:0>		high_sign	high_first_z	high_first_y	high_first_x			ro	0x00	
0x0B	tap_sign	tap_first_z	tap_first_y	tap_first_x	slope_sign	slope_first_z	slope_first_y	slope_first_x	ro	0x00		
0x0A	data_int	fifo_wm_int	fifo_full_int							ro	0x00	
0x09	flat_int	orient_int	s_tap_int	d_tap_int	slo_no_mot_int	slope_int	high_int	low_int	ro	0x00		
0x08	temp<7:0>								ro	0x00		
0x07	acc_z_msb<11:4>								ro	0x00		
0x06	acc_z_lsb<3:0>							new_data_z	ro	0x00		
0x05	acc_y_msb<11:4>								ro	0x00		
0x04	acc_y_lsb<3:0>							new_data_y	ro	0x00		
0x03	acc_x_msb<11:4>								ro	0x00		
0x02	acc_x_lsb<3:0>							new_data_x	ro	0x00		
0x01									ro	--		
0x00	chip_id<7:0>								ro	0xFA		

common w/r registers: Application specific settings which are not equal to the default settings, must be re-set to its designated values after POR, soft-reset and wake up from deep suspend.

user w/r registers: Initial default content = 0x00. Freely programmable by the user. Remains unchanged after POR, soft-reset and wake up from deep suspend.

Figure 12: Register map accelerometer part

ACC Register 0x00 (BGW_CHIPID)

The register contains the chip identification code.

Name	0x00	BGW_CHIPID			
Bit	7	6	5	4	
Read/Write	R	R	R	R	
Reset Value	n/a	n/a	n/a	n/a	
Content	chip_id<7:4>				
Bit	3	2	1	0	
Read/Write	R	R	R	R	
Reset Value	n/a	n/a	n/a	n/a	
Content	chip_id<3:0>				

chip_id<7:0>: Fixed value b'1111'1010

ACC Register 0x01 is reserved

ACC Register 0x02 (ACCD_X_LSB)

The register contains the least-significant bits of the X-channel acceleration readout value. When reading out X-channel acceleration values, data consistency is guaranteed if the ACCD_X_LSB is read out before the ACCD_X_MSB and shadow_dis='0'. In this case, after the ACCD_X_LSB has been read, the value in the ACCD_X_MSB register is locked until the ACCD_X_MSB has been read. This condition is inherently fulfilled if a burst-mode read access is performed. Acceleration data may be read from register ACCD_X_LSB at any time except during power-up and in DEEP_SUSPEND mode.

Name	0x02	ACCD_X_LSB			
Bit	7	6	5	4	
Read/Write	R	R	R	R	
Reset Value	n/a	n/a	n/a	n/a	
Content	acc_x_lsb<3:0>				
Bit	3	2	1	0	
Read/Write	R	R	R	R	
Reset Value	n/a	n/a	n/a	n/a	
Content	undefined	undefined	undefined	new_data_x	

acc_x_lsb<3:0>: Least significant 4 bits of acceleration read-back value; (two's-complement format)

undefined: random data; to be ignored.

new_data_x: ,0': acceleration value has not been updated since it has been read out last
 ,1': acceleration value has been updated since it has been read out last

ACC Register 0x03 (ACCD_X_MSB)

The register contains the most-significant bits of the X-channel acceleration readout value. When reading out X-channel acceleration values, data consistency is guaranteed if the ACCD_X_LSB is read out before the ACCD_X_MSB and shadow_dis='0'. In this case, after the ACCD_X_LSB has been read, the value in the ACCD_X_MSB register is locked until the ACCD_X_MSB has been read. This condition is inherently fulfilled if a burst-mode read access is performed. Acceleration data may be read from register ACCD_X_MSB at any time except during power-up and in DEEP_SUSPEND mode.

Name	0x02	ACCD_X_MSB		
Bit	7	6	5	4
Read/Write	R	R	R	R
Reset Value	n/a	n/a	n/a	n/a
Content	acc_x_msb<11:8>			
Bit	3	2	1	0
Read/Write	R	R	R	R
Reset Value	n/a	n/a	n/a	n/a
Content	acc_x_msb<7:4>			

acc_x_msb<11:4>: Most significant 8 bits of acceleration read-back value (two's-complement format)

ACC Register 0x04 (ACCD_Y_LSB)

The register contains the least-significant bits of the Y-channel acceleration readout value. When reading out Y-channel acceleration values, data consistency is guaranteed if the ACCD_Y_LSB is read out before the ACCD_Y_MSB and shadow_dis='0'. In this case, after the ACCD_Y_LSB has been read, the value in the ACCD_Y_MSB register is locked until the ACCD_Y_MSB has been read. This condition is inherently fulfilled if a burst-mode read access is performed. Acceleration data may be read from register ACCD_Y_LSB at any time except during power-up and in DEEP_SUSPEND mode.

Name	0x04	ACCD_Y_LSB		
Bit	7	6	5	4
Read/Write	R	R	R	R
Reset Value	n/a	n/a	n/a	n/a
Content	acc_y_lsb<3:0>			
Bit	3	2	1	0
Read/Write	R	R	R	R
Reset Value	n/a	n/a	n/a	n/a
Content	undefined	undefined	undefined	new_data_y

acc_y_lsb<3:0>: Least significant 4 bits of acceleration read-back value; (two's-complement format)

undefined: random data; to be ignored

new_data_y: ,0': acceleration value has not been updated since it has been read out last
 ,1': acceleration value has been updated since it has been read out last

ACC Register 0x05 (ACCD_Y_MSB)

The register contains the most-significant bits of the Y-channel acceleration readout value. When reading out Y-channel acceleration values, data consistency is guaranteed if the ACCD_Y_LSB is read out before the ACCD_Y_MSB and shadow_dis='0'. In this case, after the ACCD_Y_LSB has been read, the value in the ACCD_Y_MSB register is locked until the ACCD_Y_MSB has been read. This condition is inherently fulfilled if a burst-mode read access is performed. Acceleration data may be read from register ACCD_Y_MSB at any time except during power-up and in DEEP_SUSPEND mode.

Name	0x05	ACCD_Y_MSB			
Bit	7	6	5	4	
Read/Write	R	R	R	R	
Reset Value	n/a	n/a	n/a	n/a	
Content	acc_y_msb<11:8>				
Bit	3	2	1	0	
Read/Write	R	R	R	R	
Reset Value	n/a	n/a	n/a	n/a	
Content	acc_y_msb<7:4>				

acc_y_msb<11:4>: Most significant 8 bits of acceleration read-back value (two's-complement format)

ACC Register 0x06 (ACCD_Z_LSB)

The register contains the least-significant bits of the Z-channel acceleration readout value. When reading out Z-channel acceleration values, data consistency is guaranteed if the ACCD_Z_LSB is read out before the ACCD_Z_MSB and shadow_dis='0'. In this case, after the ACCD_Z_LSB has been read, the value in the ACCD_Z_MSB register is locked until the ACCD_Z_MSB has been read. This condition is inherently fulfilled if a burst-mode read access is performed. Acceleration data may be read from register ACCD_Z_LSB at any time except during power-up and in DEEP_SUSPEND mode.

Name	0x06	ACCD_Z_LSB			
Bit	7	6	5	4	
Read/Write	R	R	R	R	
Reset Value	n/a	n/a	n/a	n/a	
Content	acc_z_lsb<3:0>				

Bit	3	2	1	0
Read/Write	R	R	R	R
Reset Value	n/a	n/a	n/a	n/a
Content	undefined	undefined	undefined	new_data_z

Acc_z_lsb<3:0>: Least significant 4 bits of acceleration read-back value; (two's-complement format)

undefined: random data; to be ignored

new_data_z: ,0': acceleration value has not been updated since it has been read out last
 ,1': acceleration value has been updated since it has been read out last

ACC Register 0x07 (ACCD_Z_MSB)

The register contains the most-significant bits of the Z-channel acceleration readout value. When reading out Z-channel acceleration values, data consistency is guaranteed if the ACCD_Z_LSB is read out before the ACCD_Z_MSB and shadow_dis='0'. In this case, after the ACCD_Z_LSB has been read, the value in the ACCD_Z_MSB register is locked until the ACCD_Z_MSB has been read. This condition is inherently fulfilled if a burst-mode read access is performed. Acceleration data may be read from register ACCD_Z_MSB at any time except during power-up and in DEEP_SUSPEND mode.

Name	0x07	ACCD_Z_MSB		
Bit	7	6	5	4
Read/Write	R	R	R	R
Reset Value	n/a	n/a	n/a	n/a
Content	acc_z_msb<11:8>			
Bit	3	2	1	0
Read/Write	R	R	R	R
Reset Value	n/a	n/a	n/a	n/a
Content	acc_z_msb<7:4>			

acc_z_msb<11:4>: Most significant 8 bits of acceleration read-back value (two's-complement format)

ACC Register 0x08 (ACCD_TEMP)

The register contains the current chip temperature represented in two's complement format. A readout value of temp<7:0>=0x00 corresponds to a temperature of 23°C.

Name	0x08	ACCD_TEMP		
Bit	7	6	5	4
Read/Write	R	R	R	R
Reset Value	n/a	n/a	n/a	n/a
Content	temp<7:4>			

Bit	3	2	1	0
Read/Write	R	R	R	R
Reset Value	n/a	n/a	n/a	n/a
Content	temp<3:0>			

temp<7:0>: Temperature value (two s-complement format)

ACC Register 0x09 (INT_STATUS_0)

The register contains interrupt status flags. Each flag is associated with a specific interrupt function. It is set when the associated interrupt triggers. The setting of latch_int<3:0> controls if the interrupt signal and hence the respective interrupt flag will be permanently latched, temporarily latched or not latched. The interrupt function associated with a specific status flag must be enabled.

Name	0x09	INT_STATUS_0			
Bit	7	6	5	4	
Read/Write	R	R	R	R	
Reset Value	n/a	n/a	n/a	n/a	
Content	flat_int	orient_int	s_tap_int	d_tap_int	
Bit	3	2	1	0	
Read/Write	R	R	R	R	
Reset Value	n/a	n/a	n/a	n/a	
Content	slo_no_mot_int	slope_int	high_int	low_int	

flat_int: flat interrupt status: '0'→inactive, '1' →active
 orient_int: orientation interrupt status: '0'→inactive, '1' →active
 s_tap_int: single tap interrupt status: '0'→inactive, '1' →active
 d_tap_int: double tap interrupt status: '0'→inactive, '1' →active
 slo_not_mot_int: slow/no-motion interrupt status: '0'→inactive, '1' →active
 slope_int: slope interrupt status: '0'→inactive, '1' →active
 high_int: high-g interrupt status: '0'→inactive, '1' →active
 low_int: low-g interrupt status: '0'→inactive, '1' →active

ACC Register 0x0A (INT_STATUS_1)

The register contains interrupt status flags. Each flag is associated with a specific interrupt function. It is set when the associated interrupt engine triggers. The setting of latch_int<3:0> controls if the interrupt signal and hence the respective interrupt flag will be permanently latched, temporarily latched or not latched. The interrupt function associated with a specific status flag must be enabled.

Name	0x0A	INT_STATUS_1			
Bit	7	6	5	4	
Read/Write	R	R	R	R	

Reset Value	n/a	n/a	n/a	n/a
Content	data_int	fifo_wm_int	fifo_full_int	reserved
Bit	3	2	1	0
Read/Write	R	R	R	R
Reset Value	n/a	n/a	n/a	n/a
Content	reserved			

data_int: data ready interrupt status: '0' → inactive, '1' → active
 fifo_wm_int: FIFO watermark interrupt status: '0' → inactive, '1' → active
 fifo_full_int: FIFO full interrupt status: '0' → inactive, '1' → active
 reserved: reserved, write to '0'

ACC Register 0x0B (INT_STATUS_2)

The register contains interrupt status flags. Each flag is associated with a specific interrupt engine. It is set when the associated interrupt engine triggers. The setting of latch_int<3:0> controls if the interrupt signal and hence the respective interrupt flag will be permanently latched, temporarily latched or not latched. The interrupt function associated with a specific status flag must be enabled.

Name	0x0B	INT_STATUS_2		
Bit	7	6	5	4
Read/Write	R	R	R	R
Reset Value	n/a	n/a	n/a	n/a
Content	tap_sign	tap_first_z	tap_first_y	tap_first_x
Bit	3	2	1	0
Read/Write	R	R	R	R
Reset Value	n/a	n/a	n/a	n/a
Content	slope_sign	slope_first_z	slope_first_y	slope_first_x

tap_sign: sign of single/double tap triggering signal was '0' → positive, or '1' → negative
 tap_first_z: single/double tap interrupt: '1' → triggered by, or '0' → not triggered by z-axis
 tap_first_y: single/double tap interrupt: '1' → triggered by, or '0' → not triggered by y-axis
 tap_first_x: single/double tap interrupt: '1' → triggered by, or '0' → not triggered by x-axis
 slope_sign: slope sign of slope tap triggering signal was '0' → positive, or '1' → negative
 slope_first_z: slope interrupt: '1' → triggered by, or '0' → not triggered by z-axis
 slope_first_y: slope interrupt: '1' → triggered by, or '0' → not triggered by y-axis
 slope_first_x: slope interrupt: '1' → triggered by, or '0' → not triggered by x-axis

ACC Register 0x0C (INT_STATUS_3)

The register contains interrupt status flags. Each flag is associated with a specific interrupt engine. It is set when the associated interrupt engine triggers. With the exception of orient<3:0> the setting of latch_int<3:0> controls if the interrupt signal and hence the respective interrupt flag will be permanently latched, temporarily latched or not latched. The interrupt function associated with a specific status flag must be enabled.

Name	0x0C	INT_STATUS_3			
Bit	7	6	5	4	
Read/Write	R	R	R	R	
Reset Value	n/a	n/a	n/a	n/a	
Content	flat	orient<2:0>			

Bit	3	2	1	0
Read/Write	R	R	R	R
Reset Value	n/a	n/a	n/a	n/a
Content	high_sign	high_first_z	high_first_y	high_first_x

- flat: device is in '1' → flat, or '0' → non flat position;
only valid if (ACC 0x16) flat_en = '1'
- orient<2>: Orientation value of z-axis: '0' → upward looking, or '1' → downward looking. The flag always reflect the current orientation status, independent of the setting of latch_int<3:0>. The flag is not updated as long as an orientation blocking condition is active.
- orient<1:0>: orientation value of x-y-plane:
'00' → portrait upright; '01' → portrait upside down;
'10' → landscape left; '11' → landscape right;
The flags always reflect the current orientation status, independent of the setting of latch_int<3:0>. The flag is not updated as long as an orientation blocking condition is active.
- high_sign: sign of acceleration signal that triggered high-g interrupt was '0' → positive, '1' → negative
- high_first_z: high-g interrupt: '1' → triggered by, or '0' → not triggered by z-axis
- high_first_y: high-g interrupt: '1' → triggered by, or '0' → not triggered by y-axis
- high_first_x: high-g interrupt: '1' → triggered by, or '0' → not triggered by x-axis

ACC Register 0x0D is reserved ACC

Register 0x0E (FIFO_STATUS)

The register contains FIFO status flags.

Name	0x0E	FIFO_STATUS			
Bit	7	6	5	4	
Read/Write	R	R	R	R	
Reset	n/a	n/a	n/a	n/a	

Value				
Content	fifo_overrun	fifo_frame_counter<6:4>		
Bit	3	2	1	0
Read/Write	R	R	R	R
Reset Value	n/a	n/a	n/a	n/a
Content	fifo_frame_counter<3:0>			

fifo_overrun: FIFO overrun condition has '1' → occurred, or '0' → not occurred; flag can be cleared by writing to the FIFO configuration register FIFO_CONFIG_1 only

fifo_frame_counter<6:4>: Current fill level of FIFO buffer. An empty FIFO corresponds to 0x00. The frame counter can be cleared by reading out all frames from the FIFO buffer or writing to the FIFO configuration register FIFO_CONFIG_1.

ACC Register 0x0F (PMU_RANGE)

The register allows the selection of the accelerometer g-range.

Name	0x0F	PMU_RANGE		
Bit	7	6	5	4
Read/Write	R/W	R/W	R/W	R/W
Reset Value	0	0	0	0
Content	reserved			
Bit	3	2	1	0
Read/Write	R/W	R/W	R/W	R/W
Reset Value	0	0	1	1
Content	range<3:0>			

range<3:0>: Selection of accelerometer g-range:
 '0011b' → ±2g range; '0101b' → ±4g range; '1000b' → ±8g range;
 '1100b' → ±16g range; all other settings → reserved (do not use)

reserved: write '0'

ACC Register 0x10 (PMU_BW)

The register allows the selection of the acceleration data filter bandwidth.

Name	0x10	PMU_BW		
Bit	7	6	5	4
Read/Write	R/W	R/W	R/W	R/W
Reset Value	0	0	0	0
Content	reserved			bw<4>
Bit	3	2	1	0
Read/Write	R/W	R/W	R/W	R/W
Reset	1	1	1	1

Value			
Content	bw<3:0>		

bw<4:0>: Selection of data filter bandwidth:
 '00xxx' → 7.81 Hz, '01000' → 7.81 Hz, '01001' → 15.63 Hz,
 '01010' → 31.25 Hz, '01011' → 62.5 Hz, '01100' → 125 Hz,
 '01101' → 250 Hz, '01110' → 500 Hz, '01111' → 1000 Hz,
 '1xxxx' → 1000 Hz

reserved: write '0'

ACC Register 0x11 (PMU_LPW)

Selection of the main power modes and the low power sleep period.

Name	0x11	PMU_LPW		
Bit	7	6	5	4
Read/Write	R/W	R/W	R/W	R/W
Reset Value	0	0	0	0
Content	suspend	lowpower_en	deep_suspend	sleep_dur<3>
Bit	3	2	1	0
Read/Write	R/W	R/W	R/W	R/W
Reset Value	0	0	0	0
Content	sleep_dur<2:0>			reserved

suspend, low_power_en, deep_suspend:

Main power mode configuration setting {suspend; lowpower_en; deep_suspend}:

{0; 0; 0} → NORMAL mode;
 {0; 0; 1} → DEEP_SUSPEND mode;
 {0; 1; 0} → LOW_POWER mode;
 {1; 0; 0} → SUSPEND mode;
 {all other} → illegal

Please note that only certain power mode transitions are permitted.

sleep_dur<3:0>: Configures the sleep phase duration in LOW_POWER mode:

'0000b' to '0101b' → 0.5 ms, '0110b' → 1 ms,
 '0111b' → 2 ms, '1000b' → 4 ms,
 '1001b' → 6 ms, '1010b' → 10 ms,
 '1011b' → 25 ms, '1100b' → 50 ms,
 '1101b' → 100 ms, '1110b' → 500 ms,
 '1111b' → 1 s

Please note, that all application specific settings which are not equal to the default settings (refer to 6.2 register map), must be re-set to its designated values after DEEP_SUSPEND.

ACC Register 0x12 (PMU_LOW_POWER)

Configuration settings for low power mode.

Name	0x12	PMU_LOW_POWER		
Bit	7	6	5	4
Read/Write	R/W	R/W	R/W	R/W
Reset Value	0	0	0	0
Content	reserved	lowpower_mode	sleeptimer_mode	reserved

Bit	3	2	1	0
Read/Write	R/W	R/W	R/W	R/W
Reset Value	0	0	0	0
Content	reserved			

lowpower_mode: select '0' → LPM1, or '1' → LPM2 configuration for SUSPEND and LOW_POWER mode. In the LPM1 configuration the power consumption in LOW_POWER mode and SUSPEND mode is significantly reduced when compared to LPM2 configuration, but the FIFO is not accessible and writing to registers must be slowed down. In the LPM2 configuration the power consumption in LOW_POWER mode is reduced compared to NORMAL mode, but the FIFO is fully accessible and registers can be written to at full speed.

sleeptimer_mode: when in LOW_POWER mode '0' → use event-driven time-base mode (compatible with BMA250), or '1' → use equidistant sampling time-base mode. Equidistant sampling of data into the FIFO is maintained in equidistant time-base mode only.

reserved: write '0'

ACC Register 0x13 (ACCD_HBW)

Acceleration data acquisition and data output format.

Name	0x13	ACCD_HBW		
Bit	7	6	5	4
Read/Write	R/W	R/W	R/W	R/W
Reset Value	0	0 (1 in 8-bit mode)	0	0
Content	data_high_bw	shadow_dis	reserved	

Bit	3	2	1	0
Read/Write	R/W	R/W	R/W	R/W
Reset Value	0	0	0	0
Content	reserved			

data_high_bw: select whether '1' → unfiltered, or '0' → filtered data may be read from the acceleration data registers.

shadow_dis: '1' → disable, or '0' → the shadowing mechanism for the acceleration data output registers. When shadowing is enabled, the content of the acceleration

data component in the MSB register is locked, when the component in the LSB is read, thereby ensuring the integrity of the acceleration data during read-out. The lock is removed when the MSB is read.

reserved: write '0'

ACC Register 0x14 (BGW_SOFTRESET)

Controls user triggered reset of the sensor.

Name	0x14	BGW_SOFTRESET			
Bit	7	6	5	4	
Read/Write	W	W	W	W	
Reset Value	0	0	0	0	
Content	softreset				
Bit	3	2	1	0	
Read/Write	W	W	W	W	
Reset Value	0	0	0	0	
Content	softreset				

softreset: 0xB6 → triggers a reset. Other values are ignored. Following a delay, all user configuration settings are overwritten with their default state or the setting stored in the NVM, wherever applicable. This register is functional in all operation modes. Please note that all application specific settings which are not equal to the default settings (refer to 6.2 register map), must be reconfigured to their designated values.

ACC Register 0x15 is reserved

ACC Register 0x16 (INT_EN_0)

Controls which interrupt engines in group 0 are enabled.

Name	0x16	INT_EN_0			
Bit	7	6	5	4	
Read/Write	R/W	R/W	R/W	R/W	
Reset Value	0	0	0	0	
Content	flat_en	orient_en	s_tap_en	d_tap_en	
Bit	3	2	1	0	
Read/Write	R/W	R/W	R/W	R/W	
Reset Value	0	0	0	0	
Content	reserved	slope_en_z	slope_en_y	slope_en_x	

flat_en: flat interrupt: '0' → disabled, or '1' → enabled

orient_en: orientation interrupt: '0' → disabled, or '1' → enabled

s_tap_en: single tap interrupt: '0'→disabled, or '1' →enabled
 d_tap_en double tap interrupt: '0'→disabled, or '1' →enabled
 reserved: write '0'
 slope_en_z: slope interrupt, z-axis component: '0'→disabled, or '1' →enabled
 slope_en_y: slope interrupt, y-axis component: '0'→disabled, or '1' →enabled
 slope_en_x: slope interrupt, x-axis component: '0'→disabled, or '1' →enabled

ACC Register 0x17 (INT_EN_1)

Controls which interrupt engines in group 1 are enabled.

Name	0x17	INT_EN_1			
Bit	7	6	5	4	
Read/Write	R/W	R/W	R/W	R/W	
Reset Value	0	0	0	0	
Content	reserved	int_fwm_en	int_full_en	data_en	
Bit	3	2	1	0	
Read/Write	R/W	R/W	R/W	R/W	
Reset Value	0	0	0	0	
Content	low_en	high_en_z	high_en_y	high_en_x	

reserved: write '0'
 int_fwm_en: FIFO watermark interrupt: '0'→disabled, or '1' →enabled
 int_full_en: FIFO full interrupt: '0'→disabled, or '1' →enabled
 data_en data ready interrupt: '0'→disabled, or '1' →enabled
 low_en: low-g interrupt: '0'→disabled, or '1' →enabled
 high_en_z: high-g interrupt, z-axis component: '0'→disabled, or '1' →enabled
 high_en_y: high-g interrupt, y-axis component: '0'→disabled, or '1' →enabled
 high_en_x: high-g interrupt, x-axis component: '0'→disabled, or '1' →enabled

ACC Register 0x18 (INT_EN_2)

Controls which interrupt engines in group 2 are enabled.

Name	0x18	INT_EN_2			
Bit	7	6	5	4	
Read/Write	R/W	R/W	R/W	R/W	
Reset Value	0	0	0	0	
Content	reserved				
Bit	3	2	1	0	
Read/Write	R/W	R/W	R/W	R/W	
Reset Value	0	0	0	0	
Content	slo_no_mot_sel	slo_no_mot_en_z	slo_no_mot_en_y	slo_no_mot_en_x	

reserved: write '0'

slo_no_mot_sel: select '0'→slow-motion, '1' →no-motion interrupt function

slo_no_mot_en_z: slow/n-motion interrupt, z-axis component: '0'→disabled, or '1' →enabled

slo_no_mot_en_y: slow/n-motion interrupt, y-axis component: '0'→disabled, or '1' →enabled

slo_no_mot_en_x: slow/n-motion interrupt, x-axis component: '0'→disabled, or '1' →enabled

ACC Register 0x19 (INT_MAP_0)

Controls which interrupt signals are mapped to the INT1 pin.

Name	0x19	INT_MAP_0			
Bit	7	6	5	4	
Read/Write	R/W	R/W	R/W	R/W	
Reset Value	0	0	0	0	
Content	int1_flat	int1_orient	int1_s_tap	int1_d_tap	
Bit	3	2	1	0	
Read/Write	R/W	R/W	R/W	R/W	
Reset Value	0	0	0	0	
Content	int1_slo_no_mot	int1_slope	int1_high	int1_low	

int1_flat: map flat interrupt to INT1 pin: '0'→disabled, or '1' →enabled

int1_orient: map orientation interrupt to INT1 pin: '0'→disabled, or '1' →enabled

int1_s_tap: map single tap interrupt to INT1 pin: '0'→disabled, or '1' →enabled

int1_d_tap: map double tap interrupt to INT1 pin: '0'→disabled, or '1' →enabled

int1_slo_no_mot: map slow/no-motion interrupt to INT1 pin: '0'→disabled, or '1' →enabled

int1_slope: map slope interrupt to INT1 pin: '0'→disabled, or '1' →enabled

int1_high: map high-g to INT1 pin: '0'→disabled, or '1' →enabled

int1_low: map low-g to INT1 pin: '0'→disabled, or '1' →enabled

ACC Register 0x1A (INT_MAP_1)

Controls which interrupt signals are mapped to the INT1 and INT2 pins.

Name	0x1A	INT_MAP_1			
Bit	7	6	5	4	
Read/Write	R/W	R/W	R/W	R/W	
Reset Value	0	0	0	0	
Content	int2_data	int2_fwm	int2_full	reserved	
Bit	3	2	1	0	
Read/Write	R/W	R/W	R/W	R/W	
Reset Value	0	0	0	0	

Content	reserved	int1_full	int1_fwm	int1_data
int2_data:		map data ready interrupt to INT2 pin: '0'→disabled, or '1' →enabled		
int2_fwm:		map FIFO watermark interrupt to INT2 pin: '0'→disabled, or '1' →enabled		
int2_full:		map FIFO full interrupt to INT2 pin: '0'→disabled, or '1' →enabled		
reserved:	write '0'			
int1_full:		map FIFO full interrupt to INT1 pin: '0'→disabled, or '1' →enabled		
int1_fwm:		map FIFO watermark interrupt to INT1 pin: '0'→disabled, or '1' →enabled		
int1_data:		map data ready interrupt to INT1 pin: '0'→disabled, or '1' →enabled		

ACC Register 0x1B (INT_MAP_2)

Controls which interrupt signals are mapped to the INT2 pin.

Name	0x1B	INT_MAP_2			
Bit	7	6	5	4	
Read/Write	R/W	R/W	R/W	R/W	
Reset Value	0	0	0	0	
Content	int2_flat	int2_orient	int2_s_tap	int2_d_tap	
Bit	3	2	1	0	
Read/Write	R/W	R/W	R/W	R/W	
Reset Value	0	0	0	0	
Content	int2_slo_no_mot	int2_slope	int2_high	int2_low	

int2_flat:	map flat interrupt to INT2 pin: '0'→disabled, or '1' →enabled
int2_orient:	map orientation interrupt to INT2 pin: '0'→disabled, or '1' →enabled
int2_s_tap:	map single tap interrupt to INT2 pin: '0'→disabled, or '1' →enabled
int2_d_tap:	map double tap interrupt to INT2 pin: '0'→disabled, or '1' →enabled
int2_slo_no_mot:	map slow/no-motion interrupt to INT2 pin: '0'→disabled, or '1' →enabled
int2_slope:	map slope interrupt to INT2 pin: '0'→disabled, or '1' →enabled
int2_high:	map high-g to INT2 pin: '0'→disabled, or '1' →enabled
int2_low:	map low-g to INT2 pin: '0'→disabled, or '1' →enabled

ACC Register 0x1C is reserved

ACC Register 0x1D is reserved

ACC Register 0x1E (INT_SRC)

Contains the data source definition for interrupts with selectable data source.

Name	0x1E	INT_SRC			
Bit	7	6	5	4	
Read/Write	R/W	R/W	R/W	R/W	
Reset Value	0	0	0	0	
Content	reserved		int_src_data	int_src_tap	

Bit	3	2	1	0
Read/Write	R/W	R/W	R/W	R/W
Reset Value	0	0	0	0
Content	int_src_slo_no_mot	int_src_slope	int_src_high	int_src_low

reserved: write '0'

int_src_data: select '0' → filtered, or '1' → unfiltered data for new data interrupt

int_src_tap: select '0' → filtered, or '1' → unfiltered data for single-/double tap interrupt

int_src_slo_no_mot: select '0' → filtered, or '1' → unfiltered data for slow/no-motion interrupt

int_src_slope: select '0' → filtered, or '1' → unfiltered data for slope interrupt

int_src_high: select '0' → filtered, or '1' → unfiltered data for high-g interrupt

int_src_low: select '0' → filtered, or '1' → unfiltered data for low-g interrupt

ACC Register 0x1F is reserved

ACC Register 0x20 (INT_OUT_CTRL)

Contains the behavioural configuration (electrical behavior) of the interrupt pins.

Name	0x20	INT_OUT_CTRL		
Bit	7	6	5	4
Read/Write	R/W	R/W	R/W	R/W
Reset Value	0	0	0	0
Content	reserved			
Bit	3	2	1	0
Read/Write	R/W	R/W	R/W	R/W
Reset Value	0	1	0	1
Content	int2_od	int2_lvl	int1_od	int1_lvl

reserved: write '0'

int2_od: select '0' → push-pull, or '1' → open drain behavior for INT2 pin

int2_lvl: select '0' → active low, or '1' → active high level for INT2 pin

int1_od: select '0' → push-pull, or '1' → open drain behavior for INT1 pin

int1_lvl: select '0' → active low, or '1' → active high level for INT1 pin

ACC Register 0x21 (INT_RST_LATCH)

Contains the interrupt reset bit and the interrupt mode selection.

Name	0x21	INT_RST_LATCH			
Bit	7	6	5	4	
Read/Write	W	R/W	R/W	R/W	
Reset Value	0	0	0	0	
Content	reset_int	Reserved			
Bit	3	2	1	0	
Read/Write	R/W	R/W	R/W	R/W	
Reset Value	0	0	0	0	
Content	latch_int<3:0>				

reset_int: write '1' → clear any latched interrupts, or '0' → keep latched interrupts active

reserved: write '0'

latch_int<3:0>: '0000b' → non-latched, '0001b' → temporary, 250 ms,
 '0010b' → temporary, 500 ms, '0011b' → temporary, 1 s,
 '0100b' → temporary, 2 s, '0101b' → temporary, 4 s,
 '0110b' → temporary, 8 s, '0111b' → latched,
 '1000b' → non-latched, '1001b' → temporary, 250 μs,
 '1010b' → temporary, 500 μs, '1011b' → temporary, 1 ms,
 '1100b' → temporary, 12.5 ms, '1101b' → temporary, 25 ms,
 '1110b' → temporary, 50 ms, '1111b' → latched

ACC Register 0x22 (INT_0)

Contains the delay time definition for the low-g interrupt.

Name	0x22	INT_0			
Bit	7	6	5	4	
Read/Write	W	R/W	R/W	R/W	
Reset Value	0	0	0	0	
Content	low_dur<7:4>				
Bit	3	2	1	0	
Read/Write	R/W	R/W	R/W	R/W	
Reset Value	1	0	0	1	
Content	low_dur<3:0>				

low_dur<7:0>: low-g interrupt trigger delay according to $[low_dur<7:0> + 1] \cdot 2 \text{ ms}$ in a range from 2 ms to 512 ms; the default corresponds to a delay of 20 ms.

ACC Register 0x23 (INT_1)

Contains the threshold definition for the low-g interrupt.

Name	0x23	INT_1			
Bit	7	6	5	4	
Read/Write	W	R/W	R/W	R/W	
Reset Value	0	0	1	1	
Content	low_th<7:4>				
Bit	3	2	1	0	
Read/Write	R/W	R/W	R/W	R/W	
Reset Value	0	0	0	0	
Content	low_th<3:0>				

low_th<7:0>: low-g interrupt trigger threshold according to low_th<7:0> · 7.81 mg in a range from 0 g to 1.992 g; the default value corresponds to an acceleration of 375 mg

ACC Register 0x24 (INT_2)

Contains the low-g interrupt mode selection, the low-g interrupt hysteresis setting, and the high-g interrupt hysteresis setting.

Name	0x24	INT_2			
Bit	7	6	5	4	
Read/Write	R/W	R/W	R/W	R/W	
Reset Value	1	0	0	0	
Content	high_hy<1:0>		reserved		
Bit	3	2	1	0	
Read/Write	R/W	R/W	R/W	R/W	
Reset Value	0	0	0	1	
Content	reserved	low_mode	low_hy<1:0>		

high_hy<1:0>: hysteresis of high-g interrupt according to high_hy<1:0> · 125 mg (2-g range), high_hy<1:0> · 250 mg (4-g range), high_hy<1:0> · 500 mg (8-g range), or high_hy<1:0> · 1000 mg (16-g range)

low_mode: select low-g interrupt '0' single-axis mode, or '1' axis-summing mode

low_hy<1:0>: hysteresis of low-g interrupt according to low_hy<1:0> · 125 mg independent of the selected accelerometer g-range

ACC Register 0x25 (INT_3)

Contains the delay time definition for the high-g interrupt.

Name	0x25	INT_3		
Bit	7	6	5	4
Read/Write	R/W	R/W	R/W	R/W
Reset Value	0	0	0	0
Content	high_dur<7:4>			
Bit	3	2	1	0
Read/Write	R/W	R/W	R/W	R/W
Reset Value	1	1	1	1
Content	high_dur<3:0>			

high_dur<7:0>: high-g interrupt trigger delay according to $[high_dur<7:0> + 1] \cdot 2$ ms in a range from 2 ms to 512 ms; the default corresponds to a delay of 32 ms.

ACC Register 0x26 (INT_4)

Contains the threshold definition for the high-g interrupt.

Name	0x26	INT_4		
Bit	7	6	5	4
Read/Write	R/W	R/W	R/W	R/W
Reset Value	1	1	0	0
Content	high_th<7:4>			
Bit	3	2	1	0
Read/Write	R/W	R/W	R/W	R/W
Reset Value	0	0	0	0
Content	high_th<3:0>			

high_th<7:0>: threshold of high-g interrupt according to $high_th<7:0> \cdot 7.81$ mg (2-g range), $high_th<7:0> \cdot 15.63$ mg (4-g range), $high_th<7:0> \cdot 31.25$ mg (8-g range), or $high_th<7:0> \cdot 62.5$ mg (16-g range)

ACC Register 0x27 (INT_5)

Contains the definition of the number of samples to be evaluated for the slope interrupt (any-motion detection) and the slow/no-motion interrupt trigger delay.

Name	0x27	INT_5		
Bit	7	6	5	4
Read/Write	R/W	R/W	R/W	R/W
Reset Value	0	0	0	0
Content	slo_no_mot_dur<5:2>			

Bit	3	2	1	0
Read/Write	R/W	R/W	R/W	R/W
Reset Value	0	0	0	0
Content	slo_no_mot_dur<1:0>		slope_dur<1:0>	

slo_no_mot_dur<5:0>: Function depends on whether the slow-motion or no-motion interrupt function has been selected. If the slow-motion interrupt function has been enabled (slo_no_mot_sel = '0') then [slo_no_mot_dur<1:0>+1] consecutive slope data points must be above the slow/no-motion threshold (slo_no_mot_th) for the slow-/no-motion interrupt to trigger. If the no-motion interrupt function has been enabled (slo_no_mot_sel = '1') then slo_no_motion_dur<5:0> defines the time for which no slope data points must exceed the slow/no-motion threshold (slo_no_mot_th) for the slow/no-motion interrupt to trigger. The delay time in seconds may be calculated according with the following equation:

$$\text{slo_no_mot_dur}\langle 5:4 \rangle = \text{'b00'} \rightarrow [\text{slo_no_mot_dur}\langle 3:0 \rangle + 1]$$

$$\text{slo_no_mot_dur}\langle 5:4 \rangle = \text{'b01'} \rightarrow [\text{slo_no_mot_dur}\langle 3:0 \rangle \cdot 4 + 20]$$

$$\text{slo_no_mot_dur}\langle 5 \rangle = \text{'1'} \rightarrow [\text{slo_no_mot_dur}\langle 4:0 \rangle \cdot 8 + 88]$$

slope_dur<1:0>: slope interrupt triggers if [slope_dur<1:0>+1] consecutive slope data points are above the slope interrupt threshold slope_th<7:0>

ACC Register 0x28 (INT_6)

Contains the threshold definition for the any-motion interrupt.

Name	0x28	INT_6		
Bit	7	6	5	4
Read/Write	R/W	R/W	R/W	R/W
Reset Value	0	0	0	1
Content	slope_th<7:4>			
Bit	3	2	1	0
Read/Write	R/W	R/W	R/W	R/W
Reset Value	0	1	0	0
Content	slope_th<3:0>			

slope_th<7:0>: Threshold of the any-motion interrupt. It is range-dependent and defined as a sample-to-sample difference according to
 slope_th<7:0> · 3.91 mg (2-g range) /
 slope_th<7:0> · 7.81 mg (4-g range) /
 slope_th<7:0> · 15.63 mg (8-g range) /
 slope_th<7:0> · 31.25 mg (16-g range)

ACC Register 0x29 (INT_7)

Contains the threshold definition for the slow/no-motion interrupt.

Name	0x29	INT_7			
Bit	7	6	5	4	
Read/Write	R/W	R/W	R/W	R/W	
Reset Value	0	0	0	1	
Content	slo_no_mot_th<7:4>				
Bit	3	2	1	0	
Read/Write	R/W	R/W	R/W	R/W	
Reset Value	0	1	0	0	
Content	slo_no_mot_th<3:0>				

slo_no_mot_th<7:0>: Threshold of slow/no-motion interrupt. It is range-dependent and defined as a sample-to-sample difference according to
 slo_no_mot_th<7:0> · 3.91 mg (2-g range),
 slo_no_mot_th<7:0> · 7.81 mg (4-g range),
 slo_no_mot_th<7:0> · 15.63 mg (8-g range),
 slo_no_mot_th<7:0> · 31.25 mg (16-g range)

ACC Register 0x2A (INT_8)

Contains the timing definitions for the single tap and double tap interrupts.

Name	0x2A	INT_8			
Bit	7	6	5	4	
Read/Write	R/W	R/W	R/W	R/W	
Reset Value	0	0	0	0	
Content	tap_quiet	tap_shock	reserved	reserved	
Bit	3	2	1	0	
Read/Write	R/W	R/W	R/W	R/W	
Reset Value	0	1	0	0	
Content	reserved	tap_dur<2:0>			

tap_quiet: selects a tap quiet duration of '0' → 30 ms, '1' → 20 ms
 tap_shock: selects a tap shock duration of '0' → 50 ms, '1' → 75 ms
 reserved: write '0'
 tap_dur<2:0>: selects the length of the time window for the second shock event for double tap detection according to '000b' → 50 ms, '001b' → 100 ms, '010b' → 150 ms, '011b' → 200 ms, '100b' → 250 ms, '101b' → 375 ms, '110b' → 500 ms, '111b' → 700 ms.

ACC Register 0x2B (INT_9)

Contains the definition of the number of samples processed by the single / double-tap interrupt engine after wake-up in low-power mode. It also defines the threshold definition for the single and double tap interrupts.

Name	0x2B		INT_9	
Bit	7	6	5	4
Read/Write	R/W	R/W	R/W	R/W
Reset Value	0	0	0	0
Content	tap_samp<1:0>		reserved	tap_th<4>
Name	3	2	1	0
Read/Write	R/W	R/W	R/W	R/W
Reset Value	1	0	1	0
Content	tap_th<3:0>			

tap_samp<1:0>: selects the number of samples that are processed after wake-up in the low-power mode according to '00b' → 2 samples, '01b' → 4 samples, '10b' → 8 samples, and '11b' → 16 samples

reserved: write '0'

tap_th<4:0>: threshold of the single/double-tap interrupt corresponding to an acceleration difference of tap_th<3:0> · 62.5mg (2g-range), tap_th<3:0> · 125mg (4g-range), tap_th<3:0> · 250mg (8g-range), and tap_th<3:0> · 500mg (16g-range).

ACC Register 0x2C (INT_A)

Contains the definition of hysteresis, blocking, and mode for the orientation interrupt

Name	0x2C		INT_A	
Bit	7	6	5	4
Read/Write	R/W	R/W	R/W	R/W
Reset Value	0	0	0	1
Content	reserved	orient_hyst<2:0>		
Name	3	2	1	0
Read/Write	R/W	R/W	R/W	R/W
Reset Value	1	0	0	0
Content	orient_blocking<1:0>		orient_mode<1:0>	

reserved: write '0'

orient_hyst<2:0>: sets the hysteresis of the orientation interrupt; 1 LSB corresponds to 62.5 mg irrespective of the selected g-range

orient_blocking<1:0>: selects the blocking mode that is used for the generation of the orientation interrupt. The following blocking modes are available:

'00b' → no blocking,
 '01b' → theta blocking or acceleration in any axis > 1.5g,
 '10b' → ,theta blocking or acceleration slope in any axis > 0.2 g or
 acceleration in any axis > 1.5g
 '11b' → theta blocking or acceleration slope in any axis > 0.4 g or
 acceleration in any axis > 1.5g and value of orient is not stable for
 at least 100ms

orient_mode<1:0>:sets the thresholds for switching between the different orientations. The settings: '00b' → symmetrical, '01b' → high-asymmetrical, '10b' → low-asymmetrical, '11b' → symmetrical.

ACC Register 0x2D (INT_B)

Contains the definition of the axis orientation, up/down masking, and the theta blocking angle for the orientation interrupt.

Name	0x2D	INT_B			
Bit	7	6	5	4	
Read/Write	R/W	R/W	R/W	R/W	
Reset Value	n/a	1	0	0	
Content	reserved	orient_ud_en	orient_theta<5:4>		
Bit	3	2	1	0	
Read/Write	R/W	R/W	R/W	R/W	
Reset Value	1	0	0	0	
Content	orient_theta<3:0>				

orient_ud_en: change of up/down-bit '1' → generates an orientation interrupt, '0' → is ignored and will not generate an orientation interrupt

orient_theta<5:0>: defines a blocking angle between 0° and 44.8°

ACC Register 0x2E (INT_C)

Contains the definition of the flat threshold angle for the flat interrupt.

Name	0x2E	INT_C			
Bit	7	6	5	4	
Read/Write	R/W	R/W	R/W	R/W	
Reset Value	n/a	n/a	0	0	
Content	reserved		flat_theta<5:4>		
Bit	3	2	1	0	
Read/Write	R/W	R/W	R/W	R/W	
Reset Value	1	0	0	0	
Content	flat_theta<3:0>				

reserved: write '0'

flat_theta<5:0>: defines threshold for detection of flat position in range from 0° to 44.8°.

ACC Register 0x2F (INT_D)

Contains the definition of the flat interrupt hold time and flat interrupt hysteresis.

Name	0x2F	INT_D			
Bit	7	6	5	4	
Read/Write	R/W	R/W	R/W	R/W	
Reset Value	0	0	0	1	
Content	reserved		flat_hold_time<1:0>		
Bit	3	2	1	0	
Read/Write	R/W	R/W	R/W	R/W	
Reset Value	0	0	0	1	
Content	reserved	flat_hy<2:0>			

reserved: write '0'

flat_hold_time<1:0>: delay time for which the flat value must remain stable for the flat interrupt to be generated: '00b' → 0 ms, '01b' → 512 ms, '10b' → 1024 ms, '11b' → 2048 ms

flat_hy<2:0>: defines flat interrupt hysteresis; flat value must change by more than twice the value of flat interrupt hysteresis to detect a state change. For details see chapter 5.6.8.

'000b' → hysteresis of the flat detection disabled

ACC Register 0x30 (FIFO_CONFIG_0)

Contains the FIFO watermark level.

Name	0x30	FIFO_CONFIG_0			
Bit	7	6	5	4	
Read/Write	R/W	R/W	R/W	R/W	
Reset Value	n/a	n/a	0	0	
Content	reserved		fifo_water_mark_level_trigger_retain<5:4>		
Bit	3	2	1	0	
Read/Write	R/W	R/W	R/W	R/W	
Reset Value	0	0	0	0	
Content	fifo_water_mark_level_trigger_retain<3:0>				

reserved: write '0'

fifo_water_mark_level_trigger_retain<5:0>: fifo_water_mark_level_trigger_retain<5:0> defines the FIFO watermark level. An interrupt will be generated, when the number of entries in the FIFO is equal to fifo_water_mark_level_trigger_retain<5:0>;

ACC Register 0x31 is reserved
ACC Register 0x32 (PMU_SELF_TEST)

Contains the settings for the sensor self-test configuration and trigger.

Name	0x32	PMU_SELF_TEST		
Bit	7	6	5	4
Read/Write	R/W	R/W	R/W	R/W
Reset Value	0	0	0	0
Content	reserved			self_test_amp
Bit	3	2	1	0
Read/Write	R/W	R/W	R/W	R/W
Reset Value	0	0	0	0
Content	reserved_0	self_test_sign	self_test-axis<1:0>	

reserved: write '0x0'

reserved_0: write '0x0'

self_test_amp: select amplitude of the selftest deflection '1' → high, default value is low ('0'),

self_test_sign: select sign of self-test excitation as '1' → positive, or '0' → negative

self_test_axis: select axis to be self-tested: '00b' → self-test disabled, '01b' → x-axis, '10b' → y-axis, or '11b' → z-axis; when a self-test is performed, only the acceleration data readout value of the selected axis is valid; after the self-test has been enabled a delay of a least 50 ms is necessary for the read-out value to settle

ACC Register 0x33 (TRIM_NVM_CTRL)

Contains the control settings for the few-time programmable non-volatile memory (NVM).

Name	0x33	TRIM_NVM_CTRL		
Bit	7	6	5	4
Read/Write	R	R	R	R
Reset Value	n/a	n/a	n/a	n/a
Content	nvm_remain<3:0>			

Bit	3	2	1	0
Read/Write	R/W	R	W	R/W
Reset Value	0	n/a	0	0
Content	nvm_load	nvm_rdy	nvm_prog_trig	nvm_prog_mode

nvm_remain<3:0>: number of remaining write cycles permitted for NVM; the number is decremented each time a write to the NVM is triggered

nvm_load: '1' → trigger, or '0' → do not trigger an update of all configuration registers from NVM; the nvm_rdy flag must be '1' prior to triggering the update

nvm_rdy: status of NVM controller: '0' → NVM write / NVM update operation is in progress, '1' → NVM is ready to accept a new write or update trigger

nvm_prog_trig: '1' → trigger, or '0' → do not trigger an NVM write operation; the trigger is only accepted if the NVM was unlocked before and nvm_remain<3:0> is greater than '0'; flag nvm_rdy must be '1' prior to triggering the write cycle

nvm_prog_mode: '1' → unlock, or '0' → lock NVM write operation

ACC Register 0x34 (BGW_SPI3_WDT)

Contains settings for the digital interfaces.

Name	0x34	BGW_SPI3_WDT		
Bit	7	6	5	4
Read/Write	R/W	R/W	R/W	R/W
Reset Value	0	0	0	0
Content	reserved			
Bit	3	2	1	0
Read/Write	R/W	R/W	R/W	R/W
Reset Value	0	0	0	0
Content	reserved	i2c_wdt_en	i2c_wdt_sel	spi3

reserved: write '0'

i2c_wdt_en: if I²C interface mode is selected then '1' → enable, or '0' → disables the watchdog at the SDI pin (= SDA for I²C)

i2c_wdt_sel: select an I²C watchdog timer period of '0' → 1 ms, or '1' → 50 ms

spi3: select '0' → 4-wire SPI, or '1' → 3-wire SPI mode

ACC Register 0x35 is reserved

ACC Register 0x36 (OFC_CTRL)

Contains control signals and configuration settings for the fast and the slow offset compensation.

Name	0x36	OFC_CTRL		
Bit	7	6	5	4
Read/Write	W	W	W	R
Reset Value	0	0	0	0
Content	offset_reset	cal_trigger<1:0>		cal_rdy
Bit	3	2	1	0
Read/Write	R/W	R/W	R/W	R/W
Reset Value	0	0	0	0
Content	reserved	hp_z_en	hp_y_en	hp_x_en

offset_reset: '1' → set all offset compensation registers (0x38 to 0x3A) to zero, or '0' → keep their values

offset_trigger<1:0>: trigger fast compensation for '01b' → x-axis, '10b' → y-axis, or '11b' → z-axis; '00b' → do not trigger offset compensation; offset compensation must not be triggered when cal_rdy is '0'

cal_rdy: indicates the state of the fast compensation: '0' → offset compensation is in progress, or '1' → offset compensation is ready to be retriggered

reserved: write '0'

hp_z_en: '1' → enable, or '0' → disable slow offset compensation for the z-axis

hp_y_en: '1' → enable, or '0' → disable slow offset compensation for the y-axis

hp_x_en: '1' → enable, or '0' → disable slow offset compensation for the x-axis

ACC Register 0x37 (OFC_SETTING)

Contains configuration settings for the fast and the slow offset compensation.

Name	0x37	OFC_SETTING		
Bit	7	6	5	4
Read/Write	R/W	R/W	R/W	R/W
Reset Value	0	0	0	0
Content	reserved	offset_target_z<1:0>		offset_target_y<1>
Bit	3	2	1	0
Read/Write	R/W	R/W	R/W	R/W
Reset Value	0	0	0	0
Content	offset_target_y<0>	offset_target_x<1:0>		cut_off

reserved: write '0'

offset_target_z<1:0>: offset compensation target value for z-axis is '00b' → 0 g, '01b' → +1 g, '10b' → -1 g, or '11b' → 0 g

offset_target_y<1:0>: offset compensation target value for y-axis is '00b' → 0 g, '01b' → +1 g, '10b' → -1 g, or '11b' → 0 g

offset_target_x<1:0>: offset compensation target value for x-axis is '00b' → 0 g, '01b' → +1 g, '10b' → -1 g, or '11b' → 0 g

cut_off: select '0' → 1 Hz, or '1' → 10 Hz cut-off frequency for slow offset compensation high-pass filter

ACC Register 0x38 (OFC_OFFSET_X)

Contains the offset compensation value for x-axis acceleration readout data.

Name	0x38	OFC_OFFSET_X			
Bit	7	6	5	4	
Read/Write	R/W	R/W	R/W	R/W	
Reset Value	0	0	0	0	
Content	offset_x<7:4>				
Bit	3	2	1	0	
Read/Write	R/W	R/W	R/W	R/W	
Reset Value	0	0	0	0	
Content	offset_x<3:0>				

offset_x<7:0>: offset value, which is added to the internal filtered and unfiltered x-axis acceleration data; the offset value is represented with two's complement notation, with a mapping of +127 → +0.992g, 0 → 0 g, and -128 → -1 g; the scaling is independent of the selected g-range; the content of the offset_x<7:0> may be written to the NVM; it is automatically restored from the NVM after each power-on or softreset; offset_x<7:0> may be written directly by the user; it is generated automatically after triggering the fast offset compensation procedure for the x-axis

Example:

Original readout value	Value in offset register	Compensated readout value
0 g	127	0.992 g
0 g	0	0 g
0 g	-128	-1 g

ACC Register 0x39 (OFC_OFFSET_Y)

Contains the offset compensation value for y-axis acceleration readout data.

Name	0x39	OFC_OFFSET_Y			
Bit	7	6	5	4	
Read/Write	R/W	R/W	R/W	R/W	
Reset Value	0	0	0	0	

Content	offset_y<7:4>			
Bit	3	2	1	0
Read/Write	R/W	R/W	R/W	R/W
Reset Value	0	0	0	0
Content	offset_y<3:0>			

offset_y<7:0>: offset value, which is added to the internal filtered and unfiltered y-axis acceleration data; the offset value is represented with two's complement notation, with a mapping of +127 → +0.992g, 0 → 0 g, and -128 → -1 g; the scaling is independent of the selected g-range; the content of the offset_y<7:0> may be written to the NVM; it is automatically restored from the NVM after each power-on or softreset; offset_y<7:0> may be written directly by the user; it is generated automatically after triggering the fast offset compensation procedure for the y-axis

For reference see example at ACC Register 0x38 (OFC_OFFSET_X)

ACC Register 0x3A (OFC_OFFSET_Z)

Contains the offset compensation value for z-axis acceleration readout data.

Name	0x3A	OFC_OFFSET_Z		
Bit	7	6	5	4
Read/Write	R/W	R/W	R/W	R/W
Reset Value	0	0	0	0
Content	offset_z<7:4>			
Bit	3	2	1	0
Read/Write	R/W	R/W	R/W	R/W
Reset Value	0	0	0	0
Content	offset_z<3:0>			

offset_z<7:0>: offset value, which is added to the internal filtered and unfiltered z-axis acceleration data; the offset value is represented with two's complement notation, with a mapping of +127 → +0.992g, 0 → 0 g, and -128 → -1 g; the scaling is independent of the selected g-range; the content of the offset_z<7:0> may be written to the NVM; it is automatically restored from the NVM after each power-on or softreset; offset_z<7:0> may be written directly by the user; it is generated automatically after triggering the fast offset compensation procedure for the z-axis

For reference see example at ACC Register 0x38 (OFC_OFFSET_X)

ACC Register 0x3B (TRIM_GP0)

Contains general purpose data register with NVM back-up.

Name	0x3B	TRIM_GP0		
Bit	7	6	5	4

Read/Write	R/W	R/W	R/W	R/W
Reset Value	0	0	0	0
Content	GP0<7:4>			
Bit	3	2	1	0
Read/Write	R/W	R/W	R/W	R/W
Reset Value	0	0	0	0
Content	GP0<3:0>			

GP0<7:0>: general purpose NVM image register not linked to any sensor-specific functionality; register may be written to NVM and is restored after each power-up or softreset

ACC Register 0x3C (TRIM_GP1)

Contains general purpose data register with NVM back-up.

Name	0x3C	TRIM_GP1		
Bit	7	6	5	4
Read/Write	R/W	R/W	R/W	R/W
Reset Value	0	0	0	0
Content	GP1<7:4>			
Bit	3	2	1	0
Read/Write	R/W	R/W	R/W	R/W
Reset Value	0	0	0	0
Content	GP1<3:0>			

GP1<7:0>: general purpose NVM image register not linked to any sensor-specific functionality; register may be written to NVM and is restored after each power-up or softreset

ACC Register 0x3D is reserved

ACC Register 0x3E (FIFO_CONFIG_1)

Contains FIFO configuration settings. The FIFO buffer memory is cleared and the fifo-full flag is cleared when writing to FIFO_CONFIG_1 register.

Name	0x3E	FIFO_CONFIG_1		
Bit	7	6	5	4
Read/Write	R/W	R/W	R/W	R/W
Reset Value	0	0	0	0
Content	fifo_mode<1:0>		Reserved	

Bit	3	2	1	0
Read/Write	R/W	R/W	R/W	R/W
Reset Value	0	0	0	0
Content	Reserved		fifo_data_select<1:0>	

fifo_mode<1:0>: selects the FIFO operating mode:
 '00b' → BYPASS (buffer depth of 1 frame; old data is discarded),
 '01b' → FIFO (data collection stops when buffer is filled with 32 frames),
 '10b' → STREAM (sampling continues when buffer is full; old is discarded),
 '11b' → reserved, do not use

fifo_data_select<1:0>: selects whether '00b' → X+Y+Z, '01b' → X only, '10b' → Y only,
 '11b' → Z only acceleration data are stored in the FIFO

ACC Register 0x3F (FIFO_DATA)

FIFO data readout register. The format of the LSB and MSB components corresponds to that of the acceleration data readout registers. The new data flag is preserved. Read burst access may be used since the address counter will not increment when the read burst is started at the address of FIFO_DATA. The entire frame is discarded when a frame is only partially read out.

Name	0x3F	FIFO_DATA		
Bit	7	6	5	4
Read/Write	R	R	R	R
Reset Value	n/a	n/a	n/a	n/a
Content	fifo_data_output_register<7:4>			
Bit	3	2	1	0
Read/Write	R	R	R	R
Reset Value	n/a	n/a	n/a	n/a
Content	fifo_data_output_register<3:0>			

fifo_data_output_register<7:0>: FIFO data readout; data format depends on the setting of register fifo_data_select<1:0>:

if X+Y+Z data are selected, the data of frame n is reading out in the order of X-lsb(n), X-msb(n), Y-lsb(n), Y-msb(n), Z-lsb(n), Z-msb(n);
 if X-only is selected, the data of frame n and n+1 are reading out in the order of X-lsb(n), X-msb(n), X-lsb(n+1), X-msb(n+1); the Y-only and Z-only modes behave analogously

7 Functional description Gyroscope

Note: Default values for registers can be found in chapter 8.

7.1 Power modes gyroscope

The gyroscope has four different power modes. Besides normal mode, which represents the fully operational state of the device, there are three energy saving modes: deep-suspend mode, suspend mode, and fast power up

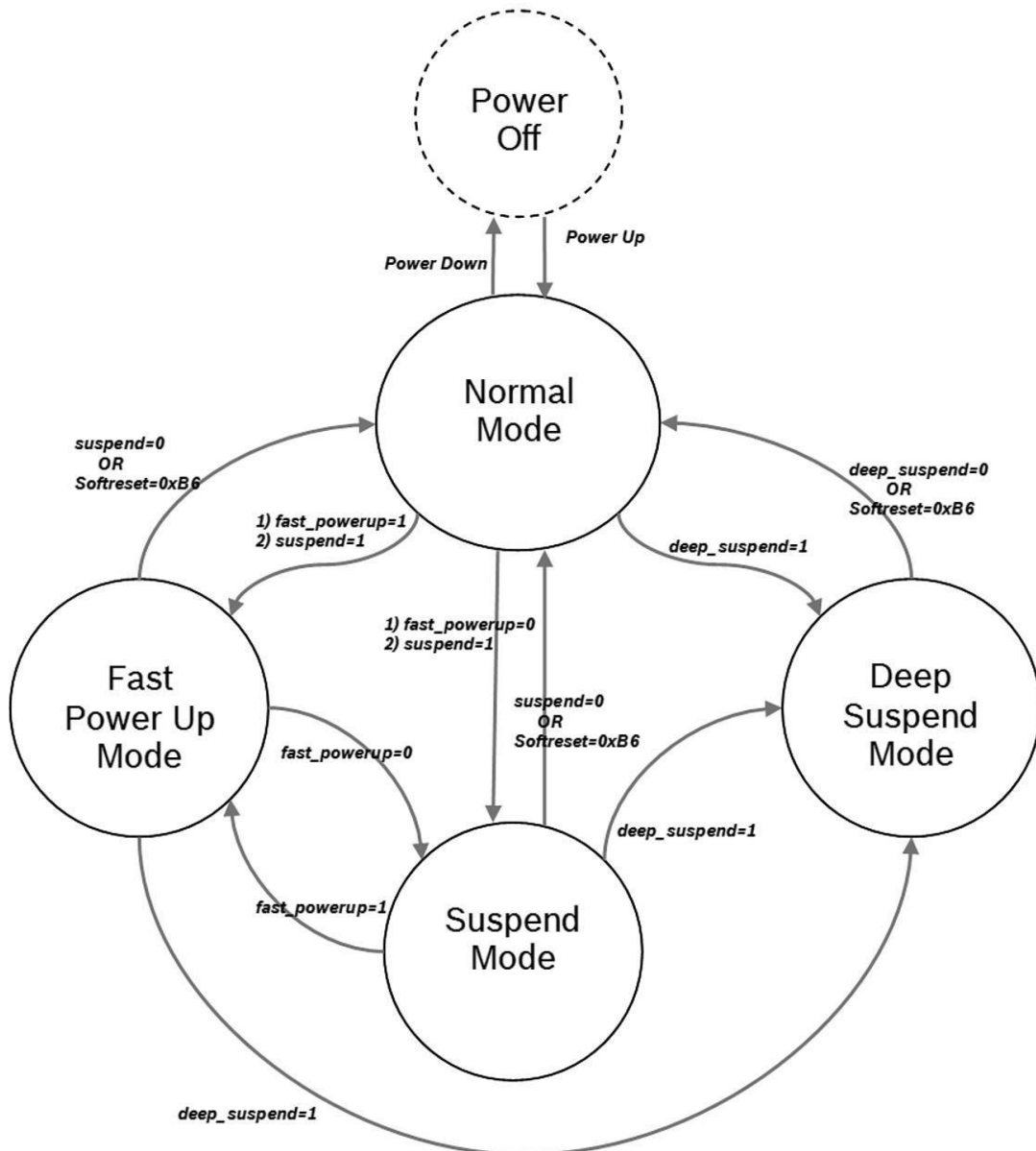

Figure 13: Block diagram of the power modes of gyroscope

After power-up gyro is in normal mode so that all parts of the device are held powered-up and data acquisition is performed continuously.

In **deep-suspend mode** the device reaches the lowest possible power consumption. Only the interface section is kept alive. No data acquisition is performed and the content of the configuration registers is lost. Deep suspend mode is entered (left) by writing '1' ('0') to the (*GYR 0x11*) *deep_suspend* bit. The I²C watchdog timer remains functional. The (*GYR 0x11*) *deep_suspend* bit, the (*GYR 0x34*) *spi3* bit, (*GYR 0x34*) *i2c_wdt_en* bit and the (*GYR 0x34*) *i2c_wdt_sel* bit are functional in deep-suspend mode. Equally the interrupt level and driver configuration registers (*GYR 0x20*) *int1_lvl*, (*GYR 0x20*) *int1_od*, (*GYR 0x20*) *int2_lvl*, and (*GYR 0x20*) *int2_od* are accessible. Still it is possible to enter normal mode by writing to the (*GYR 0x14*) *softreset* register. Please note, that all application specific settings which are not equal to the default settings (refer to 8.2 register map gyroscope), must be re-set to its designated values after leaving deep-suspend mode.

In **suspend mode** the whole analog part is powered down. No data acquisition is performed. While in suspend mode the latest rate data and the content of all configuration registers are kept. The only supported operations are reading and writing registers as well as writing to the (*GYR 0x14*) *softreset* register.

Suspend mode is entered (left) by writing '1' ('0') to the (*GYR 0x11*) *suspend* bit. Bit (*GYR 0x12*) *fast_power_up* must be set to '0'.

Although write access to registers is supported at the full interface clock speed (SCL or SCK), a waiting period must be inserted between two consecutive write cycles (please refer also to section 9.2.1).

In **external wake-up mode**, when the device is in deep suspend mode or suspend mode, it can be woken-up by external trigger to pin INT3/4. Register settings:

Table 23: Trigger source

ext_trig_sel [1:0]	Trigger source
'00'	No
'01'	INT3 pin
'10'	INT4 pin
'11'	SDO2 pin (SPI3 mode)

In **fast power-up mode** the sensing analog part is powered down, while the drive and the digital part remains largely operational. No data acquisition is performed. Reading and writing registers as well as writing to the (*GYR 0x14*) *softreset* register are supported without any restrictions. The latest rate data and the content of all configuration registers are kept. Fast power-up mode is entered (left) by writing '1' ('0') to the (*GYR 0x11*) *suspend* bit with bit (*GYR 0x12*) *fast_power_up* set to '1'.

7.1.1 Advanced power-saving modes

In addition to the power modes described in Figure 13, there are other advanced power modes that can be used to optimize the power consumption of the BMX055.

The *power_save_mode* is set by setting *power_save_mode*='1' (*GYR 0x12*). This power mode implements a duty cycle and change between normal mode and fast-power-up mode. By setting the *sleep_dur* (time in ms in fast-power-up mode) (*GYR 0x11* bits <1:3>) and *auto_sleep_dur* (time in ms in normal mode) (*GYR 0x12* bits <0:2>) different timings can be used. Some of these settings allow the sensor to consume less than 3mA. See also diagram below:

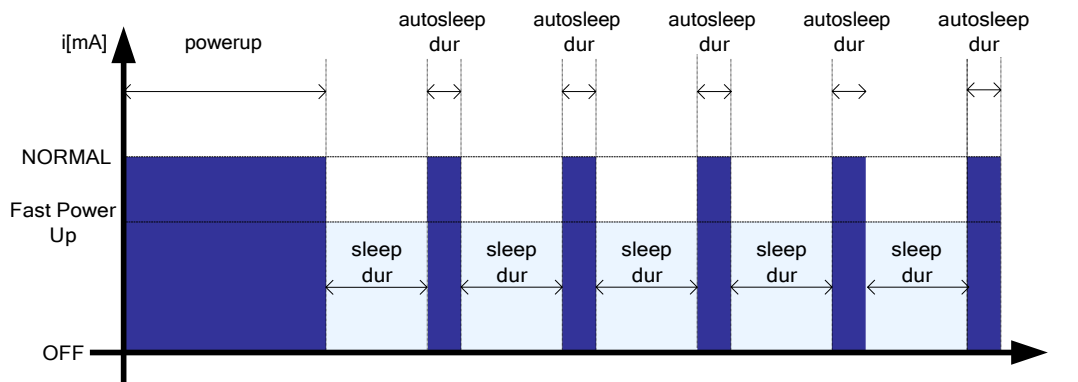

Figure 14: Duty-cycling

The possible configuration for the `autosleep_dur` and `sleep_dur` are indicated in the table below:

Table 24: Sleep durations gyroscope

<code>sleep_dur<2:0></code>	Time (ms)
'000'	2 ms
'001'	4 ms
'010'	5 ms
'011'	8 ms
'100'	10 ms
'101'	15 ms
'110'	18 ms
'111'	20 ms

Table 25: Autosleep durations gyroscope

<code>autosleep_dur<2:0></code>	Time (ms)
'000'	Not allowed
'001'	4 ms
'010'	5 ms
'011'	8 ms
'100'	10 ms
'101'	15 ms
'110'	20 ms
'111'	40 ms

The only restriction for the use of the power save mode comes from the configuration of the digital filter bandwidth (`GYR 0x10`). For each Bandwidth configuration, a minimum `autosleep_dur` must be ensured. For example, for Bandwidth=47Hz, the minimum `autosleep_dur` is 5ms. This is specified in the table below. For `sleep_dur` there is no restriction.

Table 26: Minimum autosleep duration according to bandwidth

bw<3:0>	Bandwidth (Hz)	min. autosleep_dur (ms)
'0111'	32 Hz	20 ms
'0110'	64 Hz	10 ms
'0101'	12 Hz	20 ms
'0100'	23 Hz	10 ms
'0011'	47 Hz	5 ms
'0010'	116 Hz	4 ms
'0001'	230 Hz	4 ms
'0000'	Unfiltered (523Hz)	4 ms

7.2 BMX055 Data Gyroscope

7.2.1 Rate data

The angular rate data can be read-out through addresses *GYR 0x02* through *GYR 0x07*. The angular rate data is in 2's complement form according to Table 27 below. In order to not corrupt the angular rate data, the LSB should always be read out first. Once the LSB of the x,y, or z read-out registers have been read, the MSBs are locked until the MSBs are read out.

This default behavior can be switched off by setting the address (*GYR 0x13*) bit 6 (*shadow_dis*) = '1'. In this case there is no MSB locking, and the data is updated between each read.

The burst-access mechanism provides an efficient way to read out the angular rate data in I²C or SPI mode. During a burst-access, the gyro automatically increments the starting read address after each byte. Any address in the user space can be used as a starting address. When the address (*GYR 0x3F* – *fifo_data*) is reached, the address counter is stopped. In the user space address range, the (*GYR 0x3F* – *fifo_data*) will be continuously read out until burst read ends. It is also possible to start directly with address 0x3F. In this case, the *fifo_data* (*GYR 0x3F*) data will be read out continuously. The burst-access allows data to be transferred over the I²C bus with an up to 50% reduced data density. The angular rate data in all read-out registers is locked as long as the burst read access is active. Reading the chip angular rate registers in burst read access mode ensures that the angular rate values in all readout registers belong to the same sample.

Table 27: Gyroscope register content for 16bit mode

Decimal value	Angular rate (in 2000°/s range mode)
+32767	+ 2000°/s
...	...
0	0°/s
...	...
-32767	- 2000°/s

Per default, the bandwidth of the data being read-out is limited by the internal low-pass filters according to the filter configuration. Unfiltered (high-bandwidth) data can be read out through the serial interface when the *data_high_bw* (*GYR 0x13* bit 7) is set to '1'.

7.3 Angular rate Read-Out

Bandwidth configuration: The gyro processes the 2kHz data out of the analog front end with a CIC/Decimation filter, followed by an IIR filter before sending this data to the interrupt handler. The possible decimation factors are 2, 5, 10 and 20. It is also possible to bypass these filters, and use the unfiltered 2kHz data. The decimation factor / bandwidth of the filter can be set by setting the address space GYR 0x10 bits<3:0> (bw<3:0>) as shown in the memory map section.

7.4 Self-test Gyro

A built-in self test (BIST) facility has been implemented which provides a quick way to determine if the gyroscope is operational within the specified conditions.

The BIST uses three parameters for evaluation of proper device operation:

- Drive voltage regulator
- Sense frontend offset regulator of x-,y- and z-channel
- Quad regulator for x-,y- and z-channel

If any of the three parameters is not within the limits the BIST result will be “Fail”.

To trigger the BIST 'bit0' bite_trig in address GYR 0x3C must be set '1'. When the test is performed, bit1 bist_rdy will be '1'. If the result is failed the bit bist_failed will be set to '1', otherwise stay a '0'.

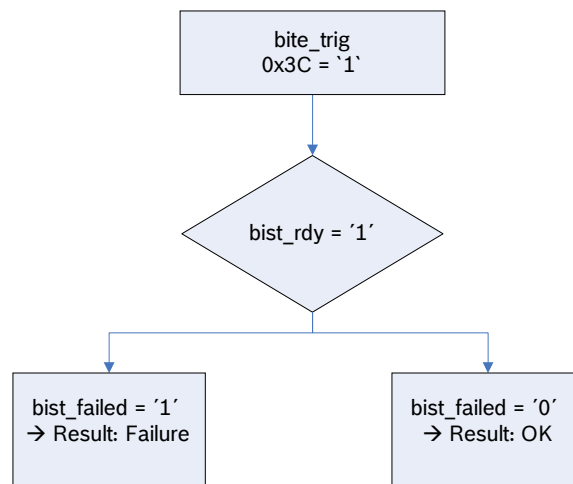

Figure 15: Flow Diagram

Another possibility to get information about the sensor status is to read out rate_ok GYR 0x3C bit4. '1' indicates proper sensor function, no trigger is needed for this.

7.5 Offset compensation gyroscope

Offsets in measured signals can have several causes but they are always unwanted and disturbing in many cases. Therefore, the gyro offers an advanced set of four digital offset compensation methods which are closely matched to each other. These are slow, fast, and manual compensation as well as inline calibration.

The compensation is performed with filtered data, and is then applied to both, unfiltered and filtered data. If necessary the result of this computation is saturated to prevent any overflow errors (the smallest or biggest possible value is set, depending on the sign). However, the registers used to read and write compensation values have a width of 8 bits.

The public offset compensation registers (*GYR 0x36*) to (*GYR 0x39*) are image of the corresponding registers in the NVM. With each image update (see section 7.6 Non-volatile memory gyroscope for details) the contents of the NVM registers are written to the public registers. The public register can be over-written by the user at any time.

In case an internally computed compensation value is too small or too large to fit into the corresponding register, it is saturated in order to prevent an overflow error.

For every axes an offset up to 125°/s with 12 bits full resolution can be calibrated (resolution 0.06°/s).

The modes will be controlled using SPI/I²C commands.

By writing '1' to the (*GYR 0x21*) *offset_reset* bit, all dynamic (fast & slow) offset compensation registers are reset to zero.

7.5.1 Slow compensation

In slow regulation mode, the rate data is monitored permanently. If the rate data is above 0°/s for a certain period of time, an adjustable rate is subtracted by the offset controller. This procedure of monitoring the rate data and subtracting of the adjustable rate at a time is repeated continuously. Thus, the output of the offset converges to 0°/s.

The slow regulation can be enabled through the *slow_offset_en_x/y/z* (*GYR 0x31 <0:2>*) bits for each axis. The slow offset cancellation will work for filtered and unfiltered data (*slow_offset_unfilt* (*GYR 0x1A <5>*); *slow_offset_unfilt=1* → unfiltered data are selected)

Slow Offset cancellation settings are the adjustable rate (*slow_offset_th 0x31 <7:6>*) and the time period (*slow_offset_dur 0x31 <5:3>*)

7.5.2 Fast compensation

A fast offset cancellation controller is implemented in gyro. The fast offset cancellation process is triggerable via SPI/I²C.

The fast offset cancellation can be enabled through the *fast_offset_en_x/y/z* (*GYR 0x32 <0:2>*) bits for each axis. The enable bits will not start the fast offset cancellation! The fast offset cancellation has to be started by setting the *fast_offset_en* (*GYR 0x32 <3>*) bit. Afterwards the algorithm will start and if the algorithm is finished the *fast_offset_en* (*GYR 0x32 <3>*) will be reset to 0.

The fast offset cancellation will work for filtered and unfiltered data (*fast_offset_unfilt* (*GYR 0x1B <7>*); *fast_offset_unfilt=1* → unfiltered data are selected)

The fast offset cancellation parameters are *fast_offset_wordlength* (*GYR 0x32 <5:4>*)

The sample rate for the fast offset cancellation corresponds to the sample rate of the selected bandwidth. For unfiltered data and bandwidth settings 0-2 the sample rate for the fast offset cancellation will be 400Hz.

The resolution of the calculated offset values for the fast offset compensation depends on the, range setting being less accurate for higher range (e.g. range=2000°/s). Therefore we recommend a range setting of range=125°/s for fast offset compensation.

7.5.3 Manual compensation

The contents of the public compensation registers (*GYR 0x36 ... 0x39*) *offset_x/y/z* can be set manually via the digital interface. It is recommended to write into these registers directly after a new data interrupt has occurred in order not to disturb running offset computations.

Writing to the offset compensation registers is not allowed while the fast compensation procedure is running.

7.5.4 Inline calibration

For certain applications, it is often desirable to calibrate the offset once and to store the compensation values permanently. This can be achieved by using one of the aforementioned offset compensation methods to determine the proper compensation values and then storing these values permanently in the NVM. See section 7.6 Non-volatile memory gyroscope for details of the storing procedure.

Each time the device is reset, the compensation values are loaded from the non-volatile memory into the image registers and used for offset compensation until they are possibly overwritten using one of the other compensation methods.

7.6 Non-volatile memory gyroscope

The entire memory of the gyro consists of three different kinds of registers: hard-wired, volatile, and non-volatile. Part of it can be both read and written by the user. Access to non-volatile memory is only possible through (volatile) image registers.

Altogether, there are eight registers (octets) with NVM backup which are accessible by the user. The addresses of the image registers range from (*GYR 0x36*) to (*GYR 0x3B*). While the addresses up to (*GYR 0x39*) are used for offset compensation (see 7.5 Offset compensation gyroscope), addresses (*GYR 0x3A*) and (*GYR 0x3B*) are general purpose registers not linked to any sensor-specific functionality.

The content of the NVM is loaded to the image registers after a reset (either POR or softreset) or after a user request which is performed by writing '1' to the write-only bit (*GYR 0x33*) *nvm_load*. As long as the image update is in progress, bit (*GYR 0x33*) *nvm_rdy* is '0', otherwise it is '1'. In order to read out the correct values (after NVM loading) waiting time is min. 1ms.

The image registers can be read and written like any other register.

Writing to the NVM is a three-step procedure:

4. Write the new contents to the image registers.
5. Write '1' to bit (*GYR 0x33*) *nvm_prog_mode* in order to unlock the NVM.
6. Write '1' to bit (*GYR 0x33*) *nvm_prog_trig* and keep '1' in bit (*GYR 0x33*) *nvm_prog_mode* in order to trigger the write process.

Writing to the NVM always renews the entire NVM contents. It is possible to check the write status by reading bit (*GYR 0x33*) *nvm_rdy*. While (*GYR 0x33*) *nvm_rdy* = '0', the write process is still in progress; if (*GYR 0x33*) *nvm_rdy* = '1', then writing is completed. As long as the write process is ongoing, no change of power mode and image registers is allowed. Also, the NVM write cycle must not be initiated while image registers are updated, in suspend mode.

Please note that the number of permitted NVM write-cycles is limited as specified in Table 3. The number of remaining write-cycles can be obtained by reading bits (*GYR 0x33*) *nvm_remain*.

7.7 Interrupt controller Gyroscope

The gyro is equipped with 3 programmable interrupt engines. Each interrupt can be independently enabled and configured. If the trigger condition of an enabled interrupt is fulfilled, the corresponding status bit is set to '1' and the selected interrupt pin is activated. The gyro provides two interrupt pins, INT3 and INT4; interrupts can be freely mapped to any of these pins. The state of a specific interrupt pin is derived from a logic 'or' combination of all interrupts mapped to it.

The interrupt status registers are updated when a new data word is written into the rate data registers. If an interrupt is disabled, all active status bits associated with it are immediately reset. Gyro Interrupts are fully functional in normal mode, only. Interrupts are limited in their functionality in other operation modes. Please contact our technical support for further assistance.

7.7.1 General features

An interrupt is cleared depending on the selected interrupt mode, which is common to all interrupts. There are three different interrupt modes: non-latched, latched, and temporary. The mode is selected by the (*GYR 0x21*) *latch_int* bits according to Table 28.

Table 28: Interrupt mode selection

(<i>GYR 0x21</i>) <i>latch_int</i>	Interrupt mode
0000b	non-latched
0001b	temporary, 250ms
0010b	temporary, 500ms
0011b	temporary, 1s
0100b	temporary, 2s
0101b	temporary, 4s
0110b	temporary, 8s
0111b	latched
1000b	non-latched
1001b	temporary, 250µs
1010b	temporary, 500µs
1011b	temporary, 1ms
1100b	temporary, 12.5ms
1101b	temporary, 25ms
1110b	temporary, 50ms
1111b	latched

An interrupt is generated if its activation condition is met. It cannot be cleared as long as the activation condition is fulfilled. In the non-latched mode the interrupt status bit and the selected pin (the contribution to the 'or' condition for INT3 and/or INT4) are cleared as soon as the

activation condition is no more valid. Exception to this behavior is the new data interrupt which is automatically reset after a fixed time.

In latched mode an asserted interrupt status and the selected pin are cleared by writing '1' to bit (*GYR 0x21*) *reset_int*. If the activation condition still holds when it is cleared, the interrupt status is asserted again with the next change of the rate registers.

In the temporary mode an asserted interrupt and selected pin are cleared after a defined period of time. The behavior of the different interrupt modes is shown graphically in Figure 16. The timings in this mode are subject to the same tolerances as the bandwidths (see Table 3).

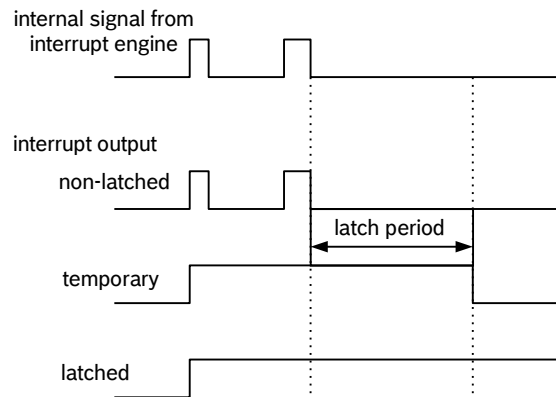

Figure 16: Interrupt modes

7.7.2 Mapping to physical interrupt pins (inttype to INT Pin#)

Registers (*GYR 0x17*) to (*GYR 0x19*) are dedicated to mapping of interrupts to the interrupt pins "INT3" or "INT4". Setting (*GYR 0x17*) *int1_*"inttype" to '1' ('0') maps (unmaps) "inttype" to pin "INT3". Correspondingly setting (*GYR 0x19*) *int2_*"inttype" to '1' ('0') maps (unmaps) "inttype" to pin "INT4".

Note: "inttype" has to be replaced with the precise notation, given in the memory map in chapter 8.

7.7.3 Electrical behaviour (INT pin# to open-drive or push-pull)

Both interrupt pins can be configured to show the desired electrical behavior. The 'active' level of each interrupt pin is determined by the (*GYR 0x16*) *int1_lvl* and (*GYR 0x16*) *int2_lvl* bits.

If (*GYR 0x16*) *int1_lvl* = '1' ('0') / (*GYR 0x16*) *int2_lvl* = '1' ('0'), then pin "INT3" / pin "INT4" is active '1' ('0'). The characteristic of the output driver of the interrupt pins may be configured with bits (*GYR 0x16*) *int1_od* and (*GYR 0x16*) *int2_od*. By setting bits (*GYR 0x16*) *int1_od* / (*GYR 0x16*) *int2_od* to '1', the output driver shows open-drive characteristic, by setting the configuration bits to '0', the output driver shows push-pull characteristic. When open-drive characteristic is selected in the design, external pull-up or pull-down resistor should be applied according the *int_lvl* configuration. When open-drive characteristic is selected in the design, external pull-up or pull-down resistor should be applied according the *int_lvl* configuration.

7.7.4 New data interrupt

This interrupt serves for synchronous reading of angular rate data. It is generated after storing a new value of z-axis angular rate data in the data register. The interrupt is cleared automatically after 280-400 μ s (depending on Interrupt settings).

The interrupt mode of the new data interrupt is fixed to non-latched.

It is enabled (disabled) by writing '1' ('0') to bit (*GYR 0x15*) *data_en*. The interrupt status is stored in bit (*GYR 0x0A*) *data_int*.

7.7.5 Any-motion detection / Interrupt

Any-motion (slope) detection uses the slope between successive angular rate signals to detect changes in motion. An interrupt is generated when the slope (absolute value of angular rate difference) exceeds a preset threshold. It is cleared as soon as the slope falls below the threshold. The principle is made clear in Figure 17.

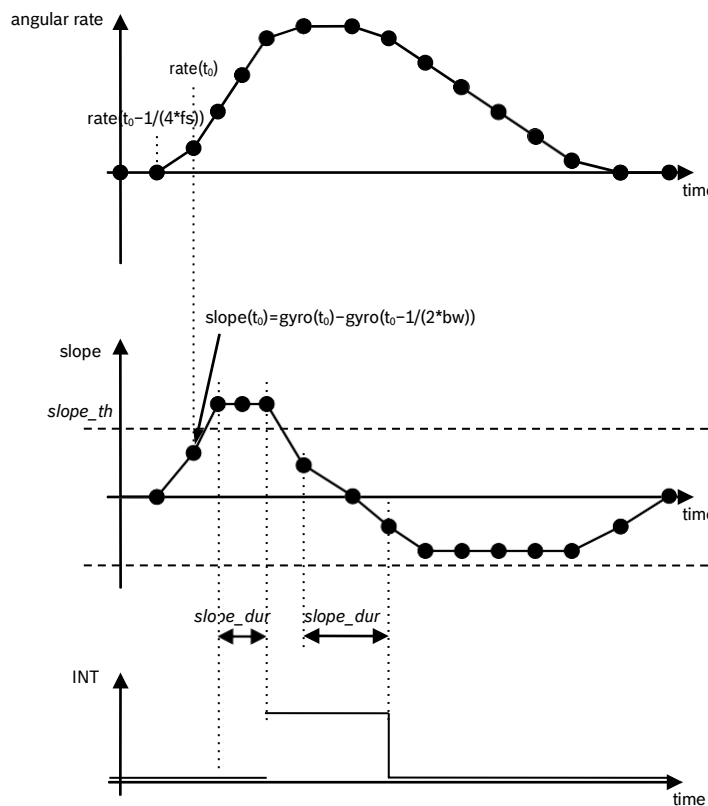

Figure 17: Principle of gyroscope any-motion detection

The threshold is defined through register (*GYR 0x1B*) *any_th*. In terms of scaling 1 LSB of (*GYR 0x1B*) *any_th* corresponds to 1 °/s in 2000°/s-range (0.5°/s in 1000°/s-range, 0.25°/s in 500°/s -range ...). Therefore the maximum value is 125°/s in 2000°/s-range (62.5°/s 1000°/s- range, 31.25°/s in 500°/s -range ...).

The time difference between the successive angular rate signals depends on the selected update rate(*fs*) which is coupled to the bandwidth and equates to $1/(4*fs)$ ($t=1/(4*fs)$). For bandwidth settings with an update rate higher than 400Hz (bandwidth =0, 1, 2) *fs* is set to 400Hz.

In order to suppress false triggers, the interrupt is only generated (cleared) if a certain number *N* of consecutive slope data points is larger (smaller) than the slope threshold given by (*GYR*

0x1B) *any_th*. This number is set by the (GYR 0x1C) *any_dursample* bits. It is $N = [(GYR\ 0x1C)\ any_dursample + 1] * 4$ for (GYR 0x1C). N is set in samples. Thus the time is scaling with the update rate (fs). Example: (GYR 0x1C) *slope_dur* = 00b, ..., 11b = 4 samples, ..., 16 samples.

7.7.5.1 Enabling (disabling) for each axis

Any-motion detection can be enabled (disabled) for each axis separately by writing '1' ('0') to bits (GYR 0x1C) *any_en_x*, (GYR 0x1C) *any_en_y*, (GYR 0x1C) *any_en_z*. The criteria for any-motion detection are fulfilled and the Any-Motion interrupt is generated if the slope of any of the enabled axes exceeds the threshold (GYR 0x1B) *any_th* for $[(GYR\ 0x1C)\ slope_dur + 1] * 4$ consecutive times. As soon as the slopes of all enabled axes fall or stay below this threshold for $[(GYR\ 0x1C)\ slope_dur + 1] * 4$ consecutive times the interrupt is cleared unless interrupt signal is latched.

7.7.5.2 Axis and sign information of slope / any motion interrupt

The interrupt status is stored in bit (GYR 0x09) *any_int*. The Any-motion interrupt supplies additional information about the detected slope. The axis which triggered the interrupt is given by that one of bits (GYR 0x0B) *any_first_x*, (GYR 0x0B) *any_first_y*, (GYR 0x0B) *any_first_z* that contains a value of '1'. The sign of the triggering slope is held in bit (GYR 0x0B) *any_sign* until the interrupt is retriggered. If (GYR 0x0B) *slope_sign* = '1' ('0'), the sign is positive (negative).

7.7.6 High-Rate interrupt

This interrupt is based on the comparison of angular rate data against a high-rate threshold for the detection of shock or other high-angular rate events. The principle is made clear in Figure 18 below:

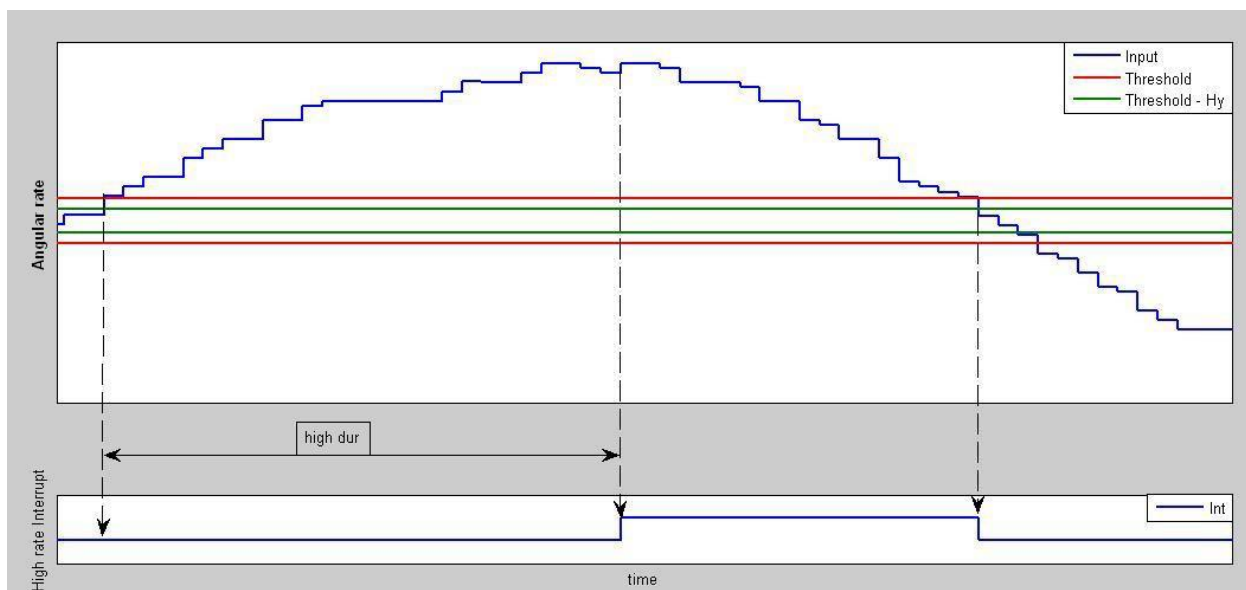

Figure 18: High rate interrupt

The high-rate interrupt is enabled (disabled) per axis by writing '1' ('0') to bits (GYR 0x22) *high_en_x*, (GYR 0x24) *high_en_y*, and (GYR 0x26) *high_en_z*, respectively. The high-rate threshold is set through the (GYR 0x22) *high_th_x* register, (GYR 0x24) *high_th_y* register and (GYR 0x26) *high_th_z* for the corresponding axes. The meaning of an LSB of (GYR 0x22/24/26) *high_th_x/y/z* depends on the selected °/s-range: it corresponds to 62.5°/s in 2000°/s-range, 31.25°/s in 1000°/s-range, 15.625°/s in 500°/s-range ...). The *high_th_x/y/z*

register setting 0 corresponds to 62.26°/s in 2000°/s-range, 31.13°/s in 1000°/s-range, 15.56°/s in 500°/s-range Therefore the maximum value is 1999.76°/s in 2000°/s-range (999.87°/s in 1000°/s-range, 499.93°/s in 500°/s -range ...).

A hysteresis can be selected by setting the (*GYR 0x22/24/26*) *high_hy_x/y/z* bits. Analogously to (*GYR 0x22/24/26*) *high_th_x/y/z*, the meaning of an LSB of (*GYR 0x22/24/26*) *high_hy_x/y/z* bits is °/s-range dependent: The *high_hy_x/y/z* register setting 0 corresponds to an angular rate difference of 62.26°/s in 2000°/s-range, 31.13°/s in 1000°/s-range, 15.56°/s in 500°/s-range The meaning of an LSB of (*GYR 0x22/24/26*) *high_hy_x/y/z* depends on the selected °/s-range too: it corresponds to 62.5°/s in 2000°/s-range, 31.25°/s in 1000°/s-range, 15.625°/s in 500°/s -range ...).

The high-rate interrupt is generated if the absolute value of the angular rate of at least one of the enabled axes ('or' relation) is higher than the threshold for at least the time defined by the (*GYR 0x23/25/27*) *high_dur_x/y/z* register. The interrupt is reset if the absolute value of the angular rate of all enabled axes ('and' relation) is lower than the threshold minus the hysteresis. In bit (*GYR 0x09*) *high_int* the interrupt status is stored. The relation between the content of (*GYR 0x23/25/27*) *high_dur_x/y/z* and the actual delay of the interrupt generation is $\text{delay [ms]} = [(\text{GYR } 0x23/25/27) \text{ high_dur_x/y/z} + 1] * 2.5 \text{ ms}$. Therefore, possible delay times range from 2.5 ms to 640 ms.

7.7.6.1 Axis and sign information of high-rate interrupt

The axis which triggered the interrupt is indicated by bits (*GYR 0x0C*) *high_first_x*, (*GYR 0x0C*) *high_first_y*, and (*GYR 0x0C*) *high_first_z*. The bit corresponding to the triggering axis contains a '1' while the other bits hold a '0'. These bits are cleared together with clearing the interrupt status. The sign of the triggering angular rate is stored in bit (*GYR 0x0C*) *high_sign*. If (*GYR 0x0C*) *high_sign* = '1' ('0'), the sign is positive (negative).

8 Register description gyroscope

8.1 General remarks

The entire communication with the device is performed by reading from and writing to registers. Registers have a width of 8 bits; they are mapped to a common space of 64 addresses from (*GYR 0x00*) up to (*GYR 0x3F*). Within the used range there are several registers which are either completely or partially marked as 'reserved'. Any reserved bit is ignored when it is written and no specific value is guaranteed when read. It is recommended not to use registers at all which are completely marked as 'reserved'. Furthermore it is recommended to mask out (logical *and* with zero) reserved bits of registers which are partially marked as reserved.

Registers with addresses from (*GYR 0x00*) up to (*GYR 0x0E*) are read-only. Any attempt to write to these registers is ignored. There are bits within some registers that trigger internal sequences. These bits are configured for write-only access, e. g. (*GYR 0x21*) *reset_int* or the entire (*GYR 0x14*) *softreset* register, and read as value '0'.

8.2 Register map gyroscope

Register Address	bit7	bit6	bit5	bit4	bit3	bit2	bit1	bit0	Access	Reset Value
0x3F	fifo_data[7]	fifo_data[6]	fifo_data[5]	fifo_data[4]	fifo_data[3]	fifo_data[2]	fifo_data[1]	fifo_data[0]	ro	0x00
0x3E	mode[1]	mode[0]					data_select[1]	data_select[0]	w/r	0x00
0x3D	tag	h2o_mrk_lv_trig_re[6]	h2o_mrk_lv_trig_re[5]	h2o_mrk_lv_trig_re[4]	h2o_mrk_lv_trig_re[3]	h2o_mrk_lv_trig_re[2]	h2o_mrk_lv_trig_re[1]	h2o_mrk_lv_trig_re[0]	w/r	0x00
0x3C			rate_ok			bist_ok	bist_rdy	trig_bist	ro	N/A
0x3B	gp0[11]	gp0[10]	gp0[9]	gp0[8]	gp0[7]	gp0[6]	gp0[5]	gp0[4]	w/r	N/A
0x3A	gp0[3]	gp0[2]	gp0[1]	gp0[0]	offset_x[1]	offset_x[0]	offset_y[0]	offset_z[0]	w/r	N/A
0x39	offset_z[11]	offset_z[10]	offset_z[9]	offset_z[8]	offset_z[7]	offset_z[6]	offset_z[5]	offset_z[4]	w/r	N/A
0x38	offset_y[11]	offset_y[10]	offset_y[9]	offset_y[8]	offset_y[7]	offset_y[6]	offset_y[5]	offset_y[4]	w/r	N/A
0x37	offset_x[11]	offset_x[10]	offset_x[9]	offset_x[8]	offset_x[7]	offset_x[6]	offset_x[5]	offset_x[4]	w/r	N/A
0x36	offset_x[3]	offset_x[2]	offset_x[3]	offset_y[2]	offset_y[1]	offset_z[3]	offset_z[2]	offset_z[1]	w/r	N/A
0x35									w/r	0x00
0x34			ext_fifo_sc_en	ext_fifo_s_set	burst_stame_en	i2c_wdt_en	i2c_wdt_sel	sp3	w/r	0x00
0x33	nvm_remain[3]	nvm_remain[2]	nvm_remain[1]	nvm_remain[0]	nvm_load	nvm_rdy	nvm_prog_trig	nvm_prog_mode	w/r	0x00
0x32	auto_offset_wordlength[1]	auto_offset_wordlength[0]	fast_offset_wordlength[1]	fast_offset_wordlength[0]	fast_offset_en	fast_offset_en_z	fast_offset_en_y	fast_offset_en_x	w/r	0x00
0x31	slow_offset_th[1]	slow_offset_th[0]	slow_offset_dur[2]	slow_offset_dur[1]	slow_offset_dur[0]	slow_offset_en_z	slow_offset_en_y	slow_offset_en_x	w/r	0x60
0x30									w/r	0xE8
0x2F									w/r	0xE9
0x2E									w/r	0x81
0x2D									w/r	0x40
0x2C									w/r	0x42
0x2B									w/r	0x22
0x2A									w/r	0xE8
0x29									w/r	0x19
0x28									w/r	0x24
0x27	high_dur_z[7]	high_dur_z[6]	high_dur_z[5]	high_dur_z[4]	high_dur_z[3]	high_dur_z[2]	high_dur_z[1]	high_dur_z[0]	w/r	0x19
0x26	high_hy_z[1]	high_hy_z[0]	high_th_z[4]	high_th_z[3]	high_th_z[2]	high_th_z[1]	high_th_z[0]	high_en_z	w/r	0x02
0x25	high_dur_y[7]	high_dur_y[6]	high_dur_y[5]	high_dur_y[4]	high_dur_y[3]	high_dur_y[2]	high_dur_y[1]	high_dur_y[0]	w/r	0x19
0x24	high_hy_y[1]	high_hy_y[0]	high_th_y[4]	high_th_y[3]	high_th_y[2]	high_th_y[1]	high_th_y[0]	high_en_y	w/r	0x02
0x23	high_dur_x[7]	high_dur_x[6]	high_dur_x[5]	high_dur_x[4]	high_dur_x[3]	high_dur_x[2]	high_dur_x[1]	high_dur_x[0]	w/r	0x19
0x22	high_hy_x[1]	high_hy_x[0]	high_th_x[4]	high_th_x[3]	high_th_x[2]	high_th_x[1]	high_th_x[0]	high_en_x	w/r	0x02
0x21	reset_int	offset_reset		latch_status_bits	latch_int[3]	latch_int[2]	latch_int[1]	latch_int[0]	w/r	0x00
0x20									w/r	0x00
0x1F									w/r	0x28
0x1E	fifo_wm_en								w/r	0x08
0x1D									w/r	0xC9
0x1C	awake_dur[1]	awake_dur[0]	any_dursample[1]	any_dursample[0]		any_en_z	any_en_y	any_en_x	w/r	0x40
0x1B	fast_offset_unlfit	any_th[6]	any_th[5]	any_th[4]	any_th[3]	any_th[2]	any_th[1]	any_th[0]	w/r	0x04
0x1A			slow_offset_unlfit		high_unlfit_data		any_unlfit_data		w/r	0x00
0x19					int2_high		int2_any		wo	0x00
0x18	int2_data	int2_fast_offset	int2_fifo	int2_auto_offset	int1_auto_offset	int1_fifo	int1_fast_offset	int1_data	w/r	0x00
0x17					int1_high		int1_any		w/r	0x00
0x16	data_en	fifo_en			int2_od	int2_lv	int1_od	int1_lv	w/r	0x0F
0x15					auto_offset_en				w/r	0x00
0x14	softreset[7]	softreset[6]	softreset[5]	softreset[4]	softreset[3]	softreset[2]	softreset[1]	softreset[0]	wo	0x00
0x13	data_high_bw	shadow_dis							wo	0x00
0x12	fast_powerup	power_save_mode	ext_trig_sel[1]	ext_trig_sel[0]		autosleep_dur[2]	autosleep_dur[1]	autosleep_dur[0]	w/r	0x00
0x11	suspend		deep_suspend		sleep_dur[2]	sleep_dur[1]	sleep_dur[0]		w/r	0x00
0x10					bw[3]	bw[2]	bw[1]	bw[0]	w/r	0x80
0x0F						range[2]	range[1]	range[0]	w/r	0x00
0x0E	Overrun	frame_counter[6]	frame_counter[5]	frame_counter[4]	frame_counter[3]	frame_counter[2]	frame_counter[1]	frame_counter[0]	ro	0x00
0x0D									ro	0x00
0x0C					high_sign	high_first_z	high_first_y	high_first_x	ro	0x00
0x0B					any_sign	any_first_z	any_first_y	any_first_x	ro	0x00
0x0A	data_int	auto_offset_int	fast_offset_int	fifo_int					ro	0x00
0x09						any_int	high_int		ro	0x00
0x08									ro	0x00
0x07	rate_z[15]	rate_z[14]	rate_z[13]	rate_z[12]	rate_z[11]	rate_z[10]	rate_z[9]	rate_z[8]	ro	0x00
0x06	rate_z[7]	rate_z[6]	rate_z[5]	rate_z[4]	rate_z[3]	rate_z[2]	rate_z[1]	rate_z[0]	ro	0x00
0x05	rate_y[15]	rate_y[14]	rate_y[13]	rate_y[12]	rate_y[11]	rate_y[10]	rate_y[9]	rate_y[8]	ro	0x00
0x04	rate_y[7]	rate_y[6]	rate_y[5]	rate_y[4]	rate_y[3]	rate_y[2]	rate_y[1]	rate_y[0]	ro	0x00
0x03	rate_x[15]	rate_x[14]	rate_x[13]	rate_x[12]	rate_x[11]	rate_x[10]	rate_x[9]	rate_x[8]	ro	0x00
0x02	rate_x[7]	rate_x[6]	rate_x[5]	rate_x[4]	rate_x[3]	rate_x[2]	rate_x[1]	rate_x[0]	ro	0x00
0x01									ro	0x00
0x00	chip_id[7]	chip_id[6]	chip_id[5]	chip_id[4]	chip_id[3]	chip_id[2]	chip_id[1]	chip_id[0]	ro	0x0F

	w/r
	write only
	read only
	res. future use

common w/r registers: Application specific settings which are not equal to the default settings, must be re-set to its designated values after POR, soft-reset and wake up from deep suspend.

user w/r registers: Initial default content = 0x00. Freely programmable by the user. Remains unchanged after POR, soft-reset and wake up from deep suspend.

Figure 19: Register map gyroscope

GYR Register 0x00 (CHIP_ID)

The register contains the chip identification code.

Name	0x00	CHIP_ID			
Bit	7	6	5	4	
Read/Write	R	R	R	R	
Reset Value	n/a	n/a	n/a	n/a	
Content	chip_id<7:4>				
Bit	3	2	1	0	
Read/Write	R	R	R	R	
Reset Value	n/a	n/a	n/a	n/a	
Content	chip_id<3:0>				

chip_id<7:0>: Fixed value b'0000'1111 =0x0F

GYR Register 0x01 is reserved

GYR Register 0x02 (RATE_X_LSB)

The register contains the least-significant bits of the X-channel angular rate readout value. When reading out X-channel angular rate values, data consistency is guaranteed if the RATE_X_LSB is read out before the RATE_X_MSB and shadow_dis='0'. In this case, after the RATE_X_LSB has been read, the value in the RATE_X_MSB register is locked until the RATE_X_MSB has been read. This condition is inherently fulfilled if a burst-mode read access is performed. Angular rate data may be read from register RATE_X_LSB at any time except during power-up and in DEEP_SUSPEND mode.

Name	0x02	RATE_X_LSB			
Bit	7	6	5	4	
Read/Write	R	R	R	R	
Reset Value	n/a	n/a	n/a	n/a	
Content	rate_x_lsb<7:4>				
Bit	3	2	1	0	
Read/Write	R	R	R	R	
Reset Value	n/a	n/a	n/a	n/a	
Content	rate_x_lsb<3:0>				

rate_x_lsb<7:0>: Least significant 8 bits of rate read-back value; (two's-complement format)

GYR Register 0x03 (RATE_X_MSB)

The register contains the most-significant bits of the X-channel angular rate readout value. When reading out X-channel angular rate values, data consistency is guaranteed if the RATE_X_LSB is read out before the RATE_X_MSB and shadow_dis='0'. In this case, after the RATE_X_LSB has been read, the value in the RATE_X_MSB register is locked until the RATE_X_MSB has been read. This condition is inherently fulfilled if a burst-mode read access is performed. Angular rate data may be read from register RATE_X_MSB at any time except during power-up and in DEEP_SUSPEND mode.

Name	0x03	RATE_X_MSB			
Bit	7	6	5	4	
Read/Write	R	R	R	R	
Reset Value	n/a	n/a	n/a	n/a	
Content	rate_x_msb<15:12>				
Bit	3	2	1	0	
Read/Write	R	R	R	R	
Reset Value	n/a	n/a	n/a	n/a	
Content	rate_x_msb<11:8>				

rate_x_msb<15:8>: Most significant 8 bits of rate read-back value (two's-complement format)

GYR Register 0x04 (RATE_Y_LSB)

The register contains the least-significant bits of the Y-channel angular rate readout value. When reading out Y-channel angular rate values, data consistency is guaranteed if the RATE_Y_LSB is read out before the RATE_Y_MSB and shadow_dis='0'. In this case, after the RATE_Y_LSB has been read, the value in the RATE_Y_MSB register is locked until the RATE_Y_MSB has been read. This condition is inherently fulfilled if a burst-mode read access is performed. Angular rate data may be read from register RATE_Y_LSB at any time except during power-up and in DEEP_SUSPEND mode.

Name	0x04	RATE_Y_LSB			
Bit	7	6	5	4	
Read/Write	R	R	R	R	
Reset Value	n/a	n/a	n/a	n/a	
Content	rate_y_lsb<7:4>				
Bit	3	2	1	0	
Read/Write	R	R	R	R	
Reset Value	n/a	n/a	n/a	n/a	
Content	rate_y_lsb<3:0>				

rate_y_lsb<7:0>: Least significant 8 bits of rate read-back value; (two's-complement format)

GYR Register 0x05 (RATE_Y_MSB)

The register contains the most-significant bits of the Y-channel angular rate readout value. When reading out Y-channel angular rate values, data consistency is guaranteed if the RATE_Y_LSB is read out before the RATE_Y_MSB and shadow_dis='0'. In this case, after the RATE_Y_LSB has been read, the value in the RATE_Y_MSB register is locked until the RATE_Y_MSB has been read. This condition is inherently fulfilled if a burst-mode read access is performed. Angular rate data may be read from register RATE_Y_MSB at any time except during power-up and in DEEP_SUSPEND mode.

Name	0x05	RATE_Y_MSB			
Bit	7	6	5	4	
Read/Write	R	R	R	R	
Reset Value	n/a	n/a	n/a	n/a	
Content	rate_y_msb<15:12>				
Bit	3	2	1	0	
Read/Write	R	R	R	R	
Reset Value	n/a	n/a	n/a	n/a	
Content	rate_y_msb<11:8>				

rate_y_msb<15:8>: Most significant 8 bits of rate read-back value (two's-complement format)

GYR Register 0x06 (RATE_Z_LSB)

The register contains the least-significant bits of the Z-channel angular rate readout value. When reading out Z-channel angular rate values, data consistency is guaranteed if the RATE_Z_LSB is read out before the RATE_Z_MSB and shadow_dis='0'. In this case, after the RATE_Z_LSB has been read, the value in the RATE_Z_MSB register is locked until the RATE_Z_MSB has been read. This condition is inherently fulfilled if a burst-mode read access is performed. Angular rate data may be read from register RATE_Z_LSB at any time except during power-up and in DEEP_SUSPEND mode.

Name	0x06	RATE_Z_LSB			
Bit	7	6	5	4	
Read/Write	R	R	R	R	
Reset Value	n/a	n/a	n/a	n/a	
Content	rate_z_lsb<7:4>				
Bit	3	2	1	0	
Read/Write	R	R	R	R	
Reset Value	n/a	n/a	n/a	n/a	
Content	rate_z_lsb<3:0>				

rate_z_lsb<7:0>: Least significant 8 bits of rate read-back value; (two's-complement format)

GYR Register 0x07 (RATE_Z_MSB)

The register contains the most-significant bits of the Z-channel angular rate readout value. When reading out Z-channel angular rate values, data consistency is guaranteed if the RATE_Z_LSB is read out before the RATE_Z_MSB and shadow_dis='0'. In this case, after the RATE_Z_LSB has been read, the value in the RATE_Z_MSB register is locked until the RATE_Z_MSB has been read. This condition is inherently fulfilled if a burst-mode read access is performed. Angular rate data may be read from register RATE_Z_MSB at any time except during power-up and in DEEP_SUSPEND mode.

Name	0x07	RATE_Z_MSB			
Bit	7	6	5	4	
Read/Write	R	R	R	R	
Reset Value	n/a	n/a	n/a	n/a	
Content	rate_z_msb<15:12>				
Bit	3	2	1	0	
Read/Write	R	R	R	R	
Reset Value	n/a	n/a	n/a	n/a	
Content	rate_z_msb<11:8>				

rate_z_msb<15:8>: Most significant 8 bits of rate read-back value (two's-complement format)

GYR Register 0x08 reserved
GYR Register 0x09 (INT_STATUS_0)

The register contains interrupt status bits.

Name	0x09	INT_STATUS_0			
Bit	7	6	5	4	
Read/Write	R	R	R	R	
Reset Value	n/a	n/a	n/a	n/a	
Content	reserved				
Bit	3	2	1	0	
Read/Write	R	R	R	R	
Reset Value	n/a	n/a	n/a	n/a	
Content	reserved	any_int	high_int	reserved	

any_int: Any motion interrupt status

high_int: High rate interrupt status

GYR Register 0x0A (INT_STATUS_1)

The register contains interrupt status bits.

Name	0x0A	INT_STATUS_1			
Bit	7	6	5	4	
Read/Write	R	R	R	R	
Reset Value	n/a	n/a	n/a	n/a	
Content	data_int	auto_offset_int	fast_offset_int	fifo_int	
Bit	3	2	1	0	
Read/Write	R	R	R	R	
Reset Value	n/a	n/a	n/a	n/a	
Content	reserved				

data_int: New data interrupt status
 auto_offset_int: Auto Offset interrupt status
 fast_offset_int: Fast Offset interrupt status
 fifo_int: Fifo interrupt status

GYR Register 0x0B (INT_STATUS_2)

The register contains any motion interrupt status bits,

Name	0x0B	INT_STATUS_2			
Bit	7	6	5	4	
Read/Write	R	R	R	R	
Reset Value	n/a	n/a	n/a	n/a	
Content	reserved				
Bit	3	2	1	0	
Read/Write	R	R	R	R	
Reset Value	n/a	n/a	n/a	n/a	
Content	any_sign	any_first_z	any_first_y	any_first_x	

any_sign: sign of any motion interrupt ('1'= positive, '0'=negative)
 any_first_z: '1' indicates that z-axis is triggering axis of any motion interrupt
 any_first_y: '1' indicates that y-axis is triggering axis of any motion interrupt
 any_first_x: '1' indicates that z-axis is triggering axis of any motion interrupt

GYR Register 0x0C (INT_STATUS_3)

The register contains high rate interrupt status bits.

Name	0x0C	INT_STATUS_3			
Bit	7	6	5	4	
Read/Write	R	R	R	R	
Reset Value	n/a	n/a	n/a	n/a	
Content	reserved				
Bit	3	2	1	0	
Read/Write	R	R	R	R	
Reset Value	n/a	n/a	n/a	n/a	
Content	high_sign	high_first_z	high_first_y	high_first_x	

high_sign: sign of high rate interrupt ('1'= positive, '0'=negative)
 high_first_z: '1' indicates that z-axis is triggering axis of high rate interrupt
 high_first_y: '1' indicates that y-axis is triggering axis of high rate interrupt
 high_first_x: '1' indicates that z-axis is triggering axis of high rate interrupt

GYR Register 0x0D is reserved

GYR Register 0x0E (FIFO_STATUS)

The register contains FIFO status flags.

Name	0x0E	FIFO_STATUS			
Bit	7	6	5	4	
Read/Write	R	R	R	R	
Reset Value	n/a	n/a	n/a	n/a	
Content	fifo_overrun	fifo_frame_counter<6:4>			
Bit	3	2	1	0	
Read/Write	R	R	R	R	
Reset Value	n/a	n/a	n/a	n/a	
Content	fifo_frame_counter<3:0>				

fifo_overrun: FIFO overrun condition has '1' → occurred, or '0' → not occurred; flag can be cleared by writing to the FIFO configuration register FIFO_CONFIG_1 only

fifo_frame_counter<6:4>: Current fill level of FIFO buffer. An empty FIFO corresponds to 0x00. The frame counter can be cleared by reading out all frames from the FIFO buffer or writing to the FIFO configuration register FIFO_CONFIG_1.

GYR Register 0x0F (RANGE)

The gyroscope supports four different angular rate measurement ranges. A measurement range is selected by setting the (0x0F) range bits as follows:

Name	0x0F	RANGE			
Bit	7	6	5	4	
Read/Write	R/W	R/W	R/W	R/W	
Reset Value	0	0	0	0	
Content	reserved				
0					
Bit	3	2	1	0	
Read/Write	R/W	R/W	R/W	R/W	
Reset Value	0	0	0	0	
Content	reserved	range<2:0>			

range<2:0>: Angular Rate Range and Resolution.

Table 29: Angular Rate Range and Resolution

range<2:0>	Full Scale	Resolution
'000'	$\pm 2000^\circ/\text{s}$	16.4 LSB/ $^\circ/\text{s}$ \Leftrightarrow 61.0 m $^\circ/\text{s}$ / LSB
'001'	$\pm 1000^\circ/\text{s}$	32.8 LSB/ $^\circ/\text{s}$ \Leftrightarrow 30.5 m $^\circ/\text{s}$ / LSB
'010'	$\pm 500^\circ/\text{s}$	65.6 LSB/ $^\circ/\text{s}$ \Leftrightarrow 15.3 m $^\circ/\text{s}$ / LSB
'011'	$\pm 250^\circ/\text{s}$	131.2 LSB/ $^\circ/\text{s}$ \Leftrightarrow 7.6 m $^\circ/\text{s}$ / LSB
'100'	$\pm 125^\circ/\text{s}$	262.4 LSB/ $^\circ/\text{s}$ \Leftrightarrow 3.8m $^\circ/\text{s}$ / LSB
'101', '110', '111'	reserved	

reserved: write '0'

GYR Register 0x10 (BW)

The register allows the selection of the rate data filter bandwidth.

Name	0x10	BW			
Bit	7	6	5	4	
Read/Write	R	R/W	R/W	R/W	
Reset Value	1	0	0	0	
Content	reserved				
0					
Bit	3	2	1	0	
Read/Write	R/W	R/W	R/W	R/W	
Reset Value	0	0	0	0	
Content	bw<3:0>				

bw<3:0>:

Table 30: Gyroscope Output data rate and filter bandwidth

0x10 bits<3:0>	Decimation Factor	ODR	Filter Bandwidth
'0111'	20	100 Hz	32 Hz
'0110'	10	200 Hz	64 Hz
'0101'	20	100 Hz	12 Hz
'0100'	10	200 Hz	23 Hz
'0011'	5	400 Hz	47 Hz
'0010'	2	1000 Hz	116 Hz
'0001'	0	2000 Hz	230 Hz
'0000'	0	2000 Hz	Unfiltered (523Hz)
'1xxx'	Unused / Reserved	Unused / Reserved	Unused / Reserved

reserved: write '0

GYR Register 0x11 (LPM1)

Selection of the main power modes.

Name	0x11				LPM1				
	Bit	7	6	5	4	3	2	1	0
Read/Write		R/W	R/W	R/W	R/W				
Reset Value		0	0	0	0				
Content		suspend	reserved	deep_suspend	reserved				
Name	0x11		LPM1		0x11		LPM1		
	Bit	3	2	1	0	3	2	1	0
Read/Write		R/W	R/W	R/W	R/W				
Reset Value		0	0	0	0				
Content		sleep_dur[2]	sleep_dur[1]	sleep_dur[0]	reserved				

suspend, deep_suspend:

Main power mode configuration setting {suspend; deep_suspend}:

- {0; 0} → NORMAL mode;
- {0; 1} → DEEP_SUSPEND mode;
- {1; 0} → SUSPEND mode;
- {all other} → illegal

Please note that only certain power mode transitions are permitted.

Please note, that all application specific settings which are not equal to the default settings (refer to 8.2 register map gyroscope), must be re-set to its designated values after DEEP_SUSPEND.

sleep_dur<2:0>: time in ms in fast-power-up mode under advanced power-saving mode.

Table 31: Sleep duration time gyroscope

sleep_dur<2:0>	Time (ms)
'000'	2 ms
'001'	4 ms
'010'	5 ms
'011'	8 ms
'100'	10 ms
'101'	15 ms
'110'	18 ms
'111'	20 ms

reserved: write '0'

GYR Register 0x12 (LPM2)

Configuration settings for fast power-up and external trigger.

Name	0x12	LPM2		
Bit	7	6	5	4
Read/Write	R/W	R/W	R/W	R/W
Reset Value	0	0	0	0
Content	fast_powerup	power_save_mode	ext_trig_sel[1]	ext_trig_sel[0]
Bit	3	2	1	0
Read/Write	R/W	R/W	R/W	R/W
Reset Value	0	0	0	0
Content	reserved	autosleep_dur[2]	autosleep_dur[1]	autosleep_dur[0]

fast powerup: 1 → Drive stays active for suspend mode in order to have a short wake-up time.....
 0 → Drive is switched off for suspend mode

ext_trig_sel<1:0>:

Table 32: external trigger gyroscope

ext_trig_sel<1:0>	Trigger source
'00'	No
'01'	INT1 pin
'10'	INT2 pin
'11'	SDO pin (SPI3 mode)

autosleep<2:0>: time in ms in normal mode under advanced power-saving mode.

Table 33: Autosleep duration gyroscope

autosleep_dur<2:0>	Time (ms)
'000'	Not allowed
'001'	4 ms
'010'	5 ms
'011'	8 ms
'100'	10 ms
'101'	15 ms
'110'	20 ms
'111'	40 ms

reserved: write '0'

GYR Register 0x13 (RATE_HBW)

Angular rate data acquisition and data output format.

Name	0x13	RATE_HBW		
Bit	7	6	5	4
Read/Write	R/W	R/W	R/W	R/W
Reset Value	0	0 (1 in 8-bit mode)	0	0
Content	data_high_bw	shadow_dis	reserved	
Bit	3	2	1	0
Read/Write	R/W	R/W	R/W	R/W
Reset Value	0	0	0	0
Content	reserved			

data_high_bw: select whether '1' → unfiltered, or '0' → filtered data may be read from the rate data registers.

shadow_dis: '1' → disable, or '0' → the shadowing mechanism for the rate data output registers. When shadowing is enabled, the content of the rate data

component in the MSB register is locked, when the component in the LSB is read, thereby ensuring the integrity of the rate data during read-out. The lock is removed when the MSB is read.

reserved: write '0'

GYR Register 0x14 (BGW_SOFTRESET)

Controls user triggered reset of the sensor.

Name	0x14				BGW_SOFTRESET			
Bit	7	6	5	4				
Read/Write	W	W	W	W				
Reset Value	0	0	0	0				
Content	softreset							
Bit	3	2	1	0				
Read/Write	W	W	W	W				
Reset Value	0	0	0	0				
Content	softreset							

softreset: 0xB6 → trigger a reset. Other values are ignored. Following a delay, all user configuration settings are overwritten with their default state or the setting stored in the NVM, wherever applicable. This register is functional in all operation modes. Please note, that all application specific settings which are not equal to the default settings (refer to 8.2 register map gyroscope), must be re-set to its designated values.

GYR Register 0x15 (INT_EN_0)

Controls which interrupts are enabled.

Name	0x15				INT_EN_0			
Bit	7	6	5	4				
Read/Write	R/W	R/W	R/W	R/W				
Reset Value	0	0	0	0				
Content	data_en	fifo_en	reserved					
Bit	3	2	1	0				
Read/Write	R/W	R/W	R/W	R/W				
Reset Value	0	0	0	0				
Content	reserved		auto_offset_en	reserved				

data_en: '1' ('0') enables (disables) new data interrupt

fifo_en: '1' ('0') enables (disables) fifo interrupt

auto_offset_en: '1' ('0') enables (disables) auto-offset compensation

reserved: write '0'

GYR Register 0x16 (INT_EN_1)

Contains interrupt pin configurations.

Name	0x16	INT_EN_1			
Bit	7	6	5	4	
Read/Write	R/W	R/W	R/W	R/W	
Reset Value	0	0	0	0	
Content	reserved				
Bit	3	2	1	0	
Read/Write	R/W	R/W	R/W	R/W	
Reset Value	1	1	1	1	
Content	int2_od	int2_lvl	int1_od	int1_lvl	

int2_od: '0' ('1') selects push-pull, '1' selects open drive for INT4

int2_lvl: '0' ('1') selects active level '0' ('1') for INT4

int1_od: '0' ('1') selects push-pull, '1' selects open drive for INT3

int1_lvl: '0' ('1') selects active level '0' ('1') for INT3

reserved: write '0'

GYR Register 0x17 (INT_MAP_0)

Controls which interrupt signals are mapped to the INT3 pin.

Name	0x17	INT_MAP_0			
Bit	7	6	5	4	
Read/Write	R/W	R/W	R/W	R/W	
Reset Value	0	0	0	0	
Content	reserved				
Bit	3	2	1	0	
Read/Write	R/W	R/W	R/W	R/W	
Reset Value	0	0	0	0	
Content	int1_high	reserved	int1_any	reserved	

int1_high: map high rate interrupt to INT3 pin: '0' → disabled, or '1' → enabled

int1_any: map Any-Motion to INT3 pin: '0' → disabled, or '1' → enabled

reserved: write '0'

GYR Register 0x18 (INT_MAP_1)

Controls which interrupt signals are mapped to the INT3 pin and INT4 pin.

Name	0x1B	INT_MAP_1		
Bit	7	6	5	4
Read/Write	R/W	R/W	R/W	R/W
Reset Value	0	0	0	0
Content	int2_data	int2_fast_offset	int2_fifo	int2_auto_offset
Bit	3	2	1	0
Read/Write	R/W	R/W	R/W	R/W
Reset Value	0	0	0	0
Content	Int1_auto_offset	int1_fifo	int1_fast_offset	int1_data

int2_data: map new data interrupt to INT4 pin: '0' → disabled, or '1' → enabled
 int2_fast_offset: map FastOffset interrupt to INT4 pin: '0' → disabled, or '1' → enabled
 int2_fifo: map Fifo interrupt to INT4 pin: '0' → disabled, or '1' → enabled
 int2_auto_offset: map AutoOffset tap interrupt to INT4 pin: '0' → disabled, or '1' → enabled
 int1_auto_offset: map AutoOffset tap interrupt to INT3 pin: '0' → disabled, or '1' → enabled
 int1_fifo: map Fifo interrupt to INT3 pin: '0' → disabled, or '1' → enabled
 int1_fast_offset: map FastOffset interrupt to INT3 pin: '0' → disabled, or '1' → enabled
 int1_data: map new data interrupt to INT3 pin: '0' → disabled, or '1' → enabled

GYR Register 0x19 (INT_MAP_2)

Controls which interrupt signals are mapped to the INT4 pin.

Name	0x19	INT_MAP_2		
Bit	7	6	5	4
Read/Write	R/W	R/W	R/W	R/W
Reset Value	0	0	0	0
Content	reserved			
Bit	3	2	1	0
Read/Write	R/W	R/W	R/W	R/W
Reset Value	0	0	0	0
Content	Int2_high	reserved	Int2_any	reserved

Int2_high: map high rate interrupt to INT4 pin: '0' → disabled, or '1' → enabled
 Int2_any: map Any-Motion to INT4 pin: '0' → disabled, or '1' → enabled
 reserved: write '0'

GYR Register 0x1A

Contains the data source definition of those interrupts with selectable data source.

Name	0x1A			
Bit	7	6	5	4
Read/Write	R/W	R/W	R/W	R/W
Reset Value	0	0	0	0
Content	reserved		slow_offset_unfilt	reserved
Bit	3	2	1	0
Read/Write	R/W	R/W	R/W	R/W
Reset Value	0	0	0	0
Content	high_unfilt_data	reserved	any_unfilt_data	reserved

slow_offset_unfilt: '1' ('0') selects unfiltered (filtered) data for slow offset compensation

high_unfilt_data: '1' ('0') selects unfiltered (filtered) data for high rate interrupt

any_unfilt_data: '1' ('0') selects unfiltered (filtered) data for any motion interrupt

reserved: write '0'

GYR Register 0x1B

Contains the data source definition of fast offset compensation and the any motion threshold.

Name	0x1B			
Bit	7	6	5	4
Read/Write	R/W	R/W	R/W	R/W
Reset Value	0	0	0	0
Content	fast_offset_unfilt	any_th <6:4>		
Bit	3	2	1	0
Read/Write	R/W	R/W	R/W	R/W
Reset Value	0	1	0	0
Content	any_th <3:0>			

fast_offset_unfilt: '1' ('0') selects unfiltered (filtered) data for fast offset compensation

any_th: $\text{any_th} = (1 + \text{any_th}(\text{register value})) * 16 \text{ LSB}$

The any_th scales with the range setting

GYR Register 0x1C

Name	0x1C			
Bit	7	6	5	4
Read/Write	R/W	R/W	R/W	R/W

Reset Value	1	0	1	0
Content	awake_dur <1:0>		any_dursample <1:0>	
Bit	3	2	1	0
Read/Write	R/W	R/W	R/W	R/W
Reset Value	0	0	0	0
Content	reserved	any_en_z	any_en_y	any_en_x

awake_dur: 0=8 samples, 1=16 samples, 2=32 samples, 3=64 samples
 any_dursample: 0=4 samples, 1=8 samples, 2=12 samples, 3=16 samples
 any_en_z: '1' ('0') enables (disables) any motion interrupt for z-axis
 any_en_y: '1' ('0') enables (disables) any motion interrupt for y-axis
 any_en_x: '1' ('0') enables (disables) any motion interrupt for z-axis
 If one of the bits any_x/y/z is enabled, the any motion interrupt is enabled
 reserved: write '0'

GYR Register 0x1D is reserved.

GYR Register 0x1E

Name	0x1E			
Bit	7	6	5	4
Read/Write	R/W	R/W	R/W	R/W
Reset Value	1	0	0	0
Content	fifo_wm_en	reserved		
Bit	3	2	1	0
Read/Write	R/W	R/W	R/W	R/W
Reset Value	1	0	0	0
Content	reserved			

fifo_wm_en: '1' ('0') enables (disables) fifo water mark level interrupt
 reserved: write '0'

GYR Register 0x1F and 0x20 are reserved

GYR Register 0x21 (INT_RST_LATCH)

Contains the interrupt reset bit and the interrupt mode selection.

Name	0x21	INT_RST_LATCH			
Bit	7	6	5	4	
Read/Write	W	R/W	R/W	R/W	
Reset Value	0	0	0	0	
Content	reset_int	offset_reset	reserved	latch_status_bit	
Bit	3	2	1	0	
Read/Write	R/W	R/W	R/W	R/W	
Reset Value	0	0	0	0	
Content	latch_int<3:0>				

reset_int: write '1' → clear any latched interrupts, or '0' → keep latched interrupts active

offset_reset: write '1' → resets internal interrupt status of each interrupt
 write '1' → resets the Offset value calculated with FastOffset, SlowOffset & AutoOffset

latch_int<3:0>: '0000b' → non-latched, '0001b' → temporary, 250 ms,
 '0010b' → temporary, 500 ms, '0011b' → temporary, 1 s,
 '0100b' → temporary, 2 s, '0101b' → temporary, 4 s,
 '0110b' → temporary, 8 s, '0111b' → latched,
 '1000b' → non-latched, '1001b' → temporary, 250 μs,
 '1010b' → temporary, 500 μs, '1011b' → temporary, 1 ms,
 '1100b' → temporary, 12.5 ms, '1101b' → temporary, 25 ms,
 '1110b' → temporary, 50 ms, '1111b' → latched

reserved: write '0'

GYR Register 0x22 (High_Th_x)

Contains the high rate threshold and high rate hysteresis setting for the x-axis

Name	0x22	High_Th_x			
Bit	7	6	5	4	
Read/Write	R/W	R/W	R/W	R/W	
Reset Value	0	0	0	0	
Content	high_hy_x <1:0>		high_th_x <4:3>		

Bit	3	2	1	0
Read/Write	R/W	R/W	R/W	R/W
Reset Value	0	0	1	0
Content	high_th_x <2:0>			high_en_x

high_hy_x: $\text{high_hy_x} = (255 + 256 * \text{high_hy_x}(\text{register value})) * 4 \text{ LSB}$

The high_hy_x scales with the range setting

high_th_x: $\text{high_th_x} = (255 + 256 * \text{high_th_x}(\text{register value})) * 4 \text{ LSB}$

The high_th_x scales with the range setting

high_en_x: '1' ('0') enables (disables) high rate interrupt for x-axis

GYR Register 0x23 (High_Dur_x)

Contains high rate duration setting for the x-axis.

Name	0x23	High_Dur_x		
Bit	7	6	5	4
Read/Write	R/W	R/W	R/W	R/W
Reset Value	0	0	0	1
Content	high_dur_x <7:4>			
Bit	3	2	1	0
Read/Write	R/W	R/W	R/W	R/W
Reset Value	1	0	0	1
Content	high_dur_x <3:0>			

high_dur_x: $\text{high_dur_time_x} = (1 + \text{high_dur_x}(\text{register value})) * 2.5 \text{ ms}$

GYR Register 0x24 (High_Th_y)

Contains the high rate threshold and high rate hysteresis setting for the y-axis.

Name	0x24	High_Th_y		
Bit	7	6	5	4
Read/Write	R/W	R/W	R/W	R/W
Reset Value	0	0	0	0
Content	high_hy_y <1:0>	high_th_y <4:3>		

Bit	3	2	1	0
Read/Write	R/W	R/W	R/W	R/W
Reset Value	0	0	1	0
Content	high_th_y <2:0>			high_en_y

high_hy_y: $high_hy_y = (255 + 256 * high_hy_y(\text{register value})) * 4 \text{ LSB}$

The high_hy_y scales with the range setting

high_th_y: $high_th_x = (255 + 256 * high_th_y(\text{register value})) * 4 \text{ LSB}$

The high_th_y scales with the range setting

high_en_y: '1' ('0') enables (disables) high rate interrupt for y-axis

GYR Register 0x25 (High_Dur_y)

Contains high rate duration setting for the x-axis.

Name	0x25	High_Dur_y			
Bit	7	6	5	4	
Read/Write	R/W	R/W	R/W	R/W	R/W
Reset Value	0	0	0	1	
Content	high_dur_y <7:4>				
Bit	3	2	1	0	
Read/Write	R/W	R/W	R/W	R/W	
Reset Value	1	0	0	1	
Content	high_dur_y <3:0>				

high_dur_y: $high_dur \text{ time}_y = (1 + high_dur_y(\text{register value})) * 2.5 \text{ ms}$

GYR Register 0x26 (High_Th_z)

Contains the high rate threshold and high rate hysteresis setting for the z-axis.

Name	0x26	High_Th_z			
Bit	7	6	5	4	
Read/Write	R/W	R/W	R/W	R/W	
Reset Value	0	0	0	0	
Content	high_hy_z <1:0>		high_th_z <4:3>		
Bit	3	2	1	0	
Read/Write	R/W	R/W	R/W	R/W	
Reset Value	0	0	1	0	
Content	high_th_z <2:0>			high_en_z	

high_hy_z: $high_hy_z = (255 + 256 * high_hx_z(\text{register value})) * 4 \text{ LSB}$
 The high_hy_x scales with the range setting

high_th_z $high_th_z = (255 + 256 * high_th_z(\text{register value})) * 4 \text{ LSB}$
 The high_th_z scales with the range setting

high_en_z '1' ('0') enables (disables) high rate interrupt for z-axis

GYR Register 0x27 (High_Dur_z)

Contains high rate duration setting for the z-axis.

Name	0x27	High_dur_z			
Bit	7	6	5	4	
Read/Write	R/W	R/W	R/W	R/W	
Reset Value	0	0	0	1	
Content	high_dur_z <7:4>				
Bit	3	2	1	0	
Read/Write	R/W	R/W	R/W	R/W	
Reset Value	1	0	0	1	
Content	high_dur_z <3:0>				

high_dur_z: $high_dur \text{ time}_z = (1 + high_dur_z(\text{register value})) * 2.5\text{ms}$

GYR Register 0x28 to 0x30 are reserved

GYR Register 0x31 (SOC)

Contains the slow offset cancellation setting.

Name	0x31	SOC			
Bit	7	6	5	4	
Read/Write	R/W	R/W	R/W	R/W	
Reset Value	0	1	1	0	
Content	Slow_offset_th<1:0>		Slow_offset_dur<2:1>		
Bit	3	2	1	0	
Read/Write	R/W	R/W	R/W	R/W	
Reset Value	0	0	0	0	
Content	Slow_offset_dur <0>	slow_offset_en_z	slow_offset_en_y	slow_offset_en_x	

Slow_offset_th: 0=0.1°/s, 1=0.2°/s, 2=0.5°/s, 3=1°/s

Slow_offset_dur: 0=40ms, 1=80ms, 2=160ms, 3=320ms, 4=640ms, 5=1280ms,

6 and 7=unused

slow_offset_en_z: '1' ('0') enables (disables) slow offset compensation for z-axis

slow_offset_en_y: '1' ('0') enables (disables) slow offset compensation for y-axis

slow_offset_en_x: '1' ('0') enables (disables) slow offset compensation for x-axis

GYR Register 0x32 (A_FOC)

Contains the fast offset cancellation setting.

Name	0x32	A_FOC			
Bit	7	6	5	4	
Read/Write	R/W	R/W	R/W	R/W	
Reset Value	1	1	0	0	
Content	auto_offset_wordlength<1:0>		fast_offset_wordlength<1:0>		
Bit	3	2	1	0	
Read/Write	R	R/W	R/W	R/W	
Reset Value	0	0	0	0	
Content	fast_offset_en	fast_offset_en_z	fast_offset_en_y	fast_offset_en_x	

auto_offset_wordlength: 0=32 samples, 1=64 samples, 2=128 samples, 3=256 samples

fast_offset_wordlength: 0=32 samples, 1=64 samples, 2=128 samples, 3=256 samples

fast_offset_en: write '1' → triggers the fast offset compensation for the enabled axes

fast_offset_en_z: '1' ('0') enables (disables) fast offset compensation for z-axis

fast_offset_en_y: '1' ('0') enables (disables) fast offset compensation for y-axis

fast_offset_en_x: '1' ('0') enables (disables) fast offset compensation for x-axis

GYR Register 0x33 (TRIM_NVM_CTRL)

Contains the control settings for the few-time programmable non-volatile memory (NVM).

Name	0x33	TRIM_NVM_CTRL			
Bit	7	6	5	4	
Read/Write	R	R	R	R	
Reset Value	n/a	n/a	n/a	n/a	
Content	nvm_remain<3:0>				
Bit	3	2	1	0	
Read/Write	R/W	R	W	R/W	
Reset Value	0	n/a	0	0	
Content	nvm_load	nvm_rdy	nvm_prog_trig	nvm_prog_mode	

nvm_remain<3:0>: number of remaining write cycles permitted for NVM; the number is decremented each time a write to the NVM is triggered
 nvm_load: '1' → trigger, or '0' → do not trigger an update of all configuration registers from NVM; the nvm_rdy flag must be '1' prior to triggering the update
 nvm_rdy: status of NVM controller: '0' → NVM write / NVM update operation is in progress, '1' → NVM is ready to accept a new write or update trigger
 nvm_prog_trig: '1' → trigger, or '0' → do not trigger an NVM write operation; the trigger is only accepted if the NVM was unlocked before and nvm_remain<3:0> is greater than '0'; flag nvm_rdy must be '1' prior to triggering the write cycle
 nvm_prog_mode: '1' → unlock, or '0' → lock NVM write operation

GYR Register 0x34 (BGW_SPI3_WDT)

Contains settings for the digital interfaces.

Name	0x34	BGW_SPI3_WDT		
Bit	7	6	5	4
Read/Write	R/W	R/W	R/W	R/W
Reset Value	0	0	0	0
Content	reserved		ext_fifo_s_en	ext_fifo_s_sel
Bit	3	2	1	0
Read/Write	R/W	R/W	R/W	R/W
Reset Value	0	0	0	0
Content	reserved	i2c_wdt_en	i2c_wdt_sel	spi3

ext_fifo_s_en: enables external FIFO synchronization mode, '1' → enable, '0' → disable
 ext_fifo_s_sel: selects source for external FIFO synchronization
 '1' → source = INT4
 '0' → source = INT3
 reserved: write '0'
 i2c_wdt_en: if I²C interface mode is selected then '1' → enable, or '0' → disables the watchdog at the SDI pin (= SDA for I²C)
 i2c_wdt_sel: select an I²C watchdog timer period of '0' → 1 ms, or '1' → 50 ms
 spi3: select '0' → 4-wire SPI, or '1' → 3-wire SPI mode

GYR Register 0x35 is reserved

GYR Register 0x36 (OFC1)

Contains offset compensation values.

Name	0x36	OFC1		
Bit	7	6	5	4
Read/Write	R/W	R/W	R/W	R/W
Reset Value	0	0	0	0
Content	offset_x<3:2>		offset_y<3:2>	
Bit	3	2	1	0
Read/Write	R/W	R/W	R/W	R/W
Reset Value	0	0	0	0
Content	offset_y<1>	offset_z<3:1>		

offset_x<3:2>: setting of offset calibration values X-channel

offset_y<3:1>: setting of offset calibration values Y-channel

offset_z<3:1>: setting of offset calibration values Z-channel

GYR Register 0x37 (OFC2)

Contains offset compensation values for X-channel.

Name	0x37	OFC2		
Bit	7	6	5	4
Read/Write	R/W	R/W	R/W	R/W
Reset Value	0	0	0	0
Content	offset_x<11:8>			
Bit	3	2	1	0
Read/Write	R/W	R/W	R/W	R/W
Reset Value	0	0	0	0
Content	offset_x<7:4>			

offset_x <11:4>: offset value, which is subtracted from the internal filtered and unfiltered x- axis data; please refer to the following table for the scaling of the offset register; the content of the offset_x<11:4> may be written to the NVM; it is automatically restored from the NVM after each power-on or softreset; offset_x<11:4> may be written directly by the user.

Table 34: Scaling of the offset register gyroscope

Original readout value	Value in offset register	Compensated readout value
0 °/s	2047	-124.94 °/s
0 °/s	0	0 °/s
0 °/s	-2048	125 °/s

GYR Register 0x38 (OFC3)

Contains offset compensation values for Y-channel.

Name	0x38	OFC3		
Bit	7	6	5	4
Read/Write	R/W	R/W	R/W	R/W
Reset Value	0	0	0	0
Content	offset_y<11:8>			
Bit	3	2	1	0
Read/Write	R/W	R/W	R/W	R/W
Reset Value	0	0	0	0
Content	offset_y<7:4>			

offset_y <11:4>: offset value, which is subtracted from the internal filtered and unfiltered y- axis data; please refer Table 34 for the scaling of the offset register; the content of the offset_y<11:4> may be written to the NVM; it is automatically restored from the NVM after each power-on or softreset; offset_y<11:4> may be written directly by the user.

For reference see example at GYR Register 0x38 (OFC2)

GYR Register 0x39 (OFC4)

Contains offset compensation values for Z-channel.

Name	0x39	OFC4		
Bit	7	6	5	4
Read/Write	R/W	R/W	R/W	R/W
Reset Value	0	0	0	0
Content	offset_z<11:8>			
Bit	3	2	1	0
Read/Write	R/W	R/W	R/W	R/W
Reset Value	0	0	0	0
Content	offset_z<7:4>			

offset_z <11:4>: offset value, which is subtracted from the internal filtered and unfiltered z- axis data; please Table 34 for the scaling of the offset register; the content of

the offset_z<11:4> may be written to the NVM; it is automatically restored from the NVM after each power-on or softreset; offset_z<11:4> may be written directly by the user.

For reference see example at GYR Register 0x38 (OFC2)

GYR Register 0x3A (TRIM_GP0)

Contains general purpose data register with NVM back-up.

Name	0x3A	TRIM_GP0		
Bit	7	6	5	4
Read/Write	R/W	R/W	R/W	R/W
Reset Value	X	X	X	X
Content	GP0<3:0>			
Bit	3	2	1	0
Read/Write	R/W	R/W	R/W	R/W
Reset Value	X	X	X	X
Content	offset_x<1:0>		offset_y<0>	offset_z<0>

GP0<3:0>: general purpose NVM image register not linked to any sensor-specific functionality; register may be written to NVM and is restored after each power-up or software reset

offset_x<1:0>: setting of offset calibration values X-channel

offset_y<0>: setting of offset calibration values Y-channel

offset_z<0> setting of offset calibration values Z-channel

GYR Register 0x3B (TRIM_GP1)

Contains general purpose data register with NVM back-up.

Name	0x3B	TRIM_GP1		
Bit	7	6	5	4
Read/Write	R/W	R/W	R/W	R/W
Reset Value	X	X	X	X
Content	GP1<7:4>			
Bit	3	2	1	0
Read/Write	R/W	R/W	R/W	R/W
Reset Value	X	X	X	X
Content	GP1<3:0>			

GP1<7:0>: general purpose NVM image register not linked to any sensor-specific functionality; register may be written to NVM and is restored after each power-up or software reset

GYR Register 0x3C (BIST)

Contains Built in Self-Test (BIST) possibilities:

Name	0x3C	BIST			
Bit	7	6	5	4	
Read/Write	R/W	R/W	R/W	R/W	
Reset Value	0	0	0	0	
Content	reserved	reserved	reserved	rate_ok	
Bit	3	2	1	0	
Read/Write	R/W	R/W	R/W	R	
Reset Value	0	0	0	0	
Content	reserved	bist_fail	bist_rdy	trig_bist	

Rate ok: '1' indicates proper sensor function, no trigger is needed for this

Trig_bist: write '1' in order to perform the bist test

 Bist_rdy: if bist_rdy is '1' and bist_fail is '0' result of bist test is ok means "sensor ok"
 If bist_rdy is '1' and bist_fail is '1' result of bist test is not ok means "sensor values not in expected range"

GYR Register 0x3D (FIFO_CONFIG_0)

Contains the FIFO watermark level.

Name	0x3D	FIFO_CONFIG_0			
Bit	7	6	5	4	
Read/Write	R/W	R/W	R/W	R/W	
Reset Value	n/a	n/a	0	0	
Content	tag	fifo_water_mark_level_trigger_retain<6:4>			
Bit	3	2	1	0	
Read/Write	R/W	R/W	R/W	R/W	
Reset Value	0	0	0	0	
Content	fifo_water_mark_level_trigger_retain<3:0>				

tag: '1' ('0') enables (disables) fifo tag (interrupt)

Table 35: FIFO watermark level configuration

Address: 0x3D bit 7	tag	Interrupt data stored in FIFO
'0' Default)		Do not collect Interrupts
'1'		collect Interrupts

fifo_water_mark_level_trigger_retain<6:0>:

fifo_water_mark_level_trigger_retain<6:0> defines the FIFO watermark level. An interrupt will be generated, when the number of entries in the FIFO exceeds fifo_water_mark_level_trigger_retain<6:0>;

GYR Register 0x3E (FIFO_CONFIG_1)

Register 0x3 contains FIFO configuration settings. The FIFO buffer memory is cleared and the fifo-full flag is cleared when writing to FIFO_CONFIG_1 register.

Name	0x3E	FIFO_CONFIG_1		
Bit	7	6	5	4
Read/Write	R/W	R/W	R/W	R/W
Reset Value	0	0	0	0
Content	fifo_mode<1:0>		Reserved	
Bit	3	2	1	0
Read/Write	R/W	R/W	R/W	R/W
Reset Value	0	0	0	0
Content	Reserved		fifo_data_select<1:0>	

fifo_mode<1:0>: selects the FIFO operating mode:
 '00b' → BYPASS (buffer depth of 1 frame; old data is discarded),
 '01b' → FIFO (data collection stops when buffer is filled with 100 frames),
 '10b' → STREAM (sampling continues when buffer is full; old is discarded),
 '11b' → reserved, do not use

fifo_data_select<1:0>:

Table 36: Gyroscope FIFO data selection

Address: 0x3E bits<1:0> data_select	data of axis stored in FIFO
'00' (Default)	X, Y, Z
'01'	X only
'10'	Y only
'11'	Z only

reserved: write '0'

GYR Register 0x3F (FIFO_DATA)

FIFO data readout register. The format of the LSB and MSB components corresponds to that of the angular rate data readout registers.. Read burst access may be used since the address counter will not increment when the read burst is started at the address of FIFO_DATA. The entire frame is discarded when a frame is only partially read out.



Name	0x3F	FIFO_DATA		
Bit	7	6	5	4
Read/Write	R	R	R	R
Reset Value	n/a	n/a	n/a	n/a
Content	fifo_data_output_register<7:4>			
Bit	3	2	1	0
Read/Write	R	R	R	R
Reset Value	n/a	n/a	n/a	n/a
Content	fifo_data_output_register<3:0>			

fifo_data_output_register<7:0>:

FIFO data readout; data format depends on the setting of register fifo_data_select<1:0>:

if X+Y+Z data are selected, the data of frame n is reading out in the order of X-lsb(n), X-msb(n), Y-lsb(n), Y-msb(n), Z-lsb(n), Z-msb(n);

if X-only is selected, the data of frame n and n+1 are reading out in the order of X-lsb(n), X-msb(n), X-lsb(n+1), X-msb(n+1); the Y-only and Z-only modes behave analogously

9 Functional description magnetometer

9.1 Magnetometer power management

The device contains a power on reset (POR) generator. It resets the logic part and the register values of the concerned ASIC after powering-on V_{DD} and V_{DDIO} . Please note, that all application specific settings which are not equal to the default settings (refer to register maps chapter 10 and chapter 10.2), must be re-set to its designated values after POR.

9.2 Magnetometer power modes

The magnetometer features configurable power modes. It has four power modes: In the following chapters, power modes are described.

9.2.1 Power off mode

In Power off mode, V_{DD} and/or V_{DDIO} are unpowered and the device does not operate. When only one of V_{DD} or V_{DDIO} is supplied, the magnetic sensor will still be in Power off mode. Power on reset is performed after both V_{DD} and V_{DDIO} have risen above their detection thresholds.

9.2.2 Suspend mode

Suspend mode is the default power mode of magnetometer after the chip is powered. When V_{DD} and V_{DDIO} are turned on the POR (power on reset) circuits operate and the device's registers are initialized. After POR becomes inactive, a start up sequence is executed. In this sequence NVM content is downloaded to shadow registers located in the device core. After the start up sequence the device is put in the Suspend mode. In this mode only registers which store power control bit information and SPI3 wire enable can be accessed by the user. No other registers can be accessed in Suspend mode. All registers lose their content, except the control register (0x4B). In particular, in this mode a Chip ID read (register 0x40) returns "0x00" (I²C) or high-Z (SPI).

9.2.3 Sleep mode

The user puts device from suspend into Sleep mode by setting the Power bit to "1", or from active modes (normal or forced) by setting OpMode bits to "11". In this state the user has full access to the device registers. In particular, the Chip ID can be read. Setting the power control bit to "0" (register 0x4B bit0) will bring the device back into Suspend mode. From the Sleep mode the user can put the device back into Suspend mode or into Active mode.

9.2.4 Active mode

The device can switch into Active mode from Sleep mode by setting OpMode bits (register 0x4C). In this mode the magnetic field measurements are performed and all registers are accessible. In active mode, two operation modes can be distinguished:

- Normal mode: selected channels are periodically measured according to settings set in user registers. After measurements are completed, output data is put into data registers and the device waits for the next measurement period, which is set by programmed output data rate (ODR). From normal mode, the user can return to sleep mode by setting OpMode to "11" or by performing a soft reset (see chapter 10.6). Suspend mode can be entered by setting power control bit to "0".
- Forced mode (single measurement): When set by the host, the selected channels are measured according to settings programmed in user registers. After measurements are completed, output data is put into data registers, OpMode register value returns to "11" and the device returns to sleep mode. The forced mode is useful to achieve

synchronized operation between host microcontroller and magnetometer. Also, different data output rates from the ones selectable in normal mode can be achieved using forced mode.

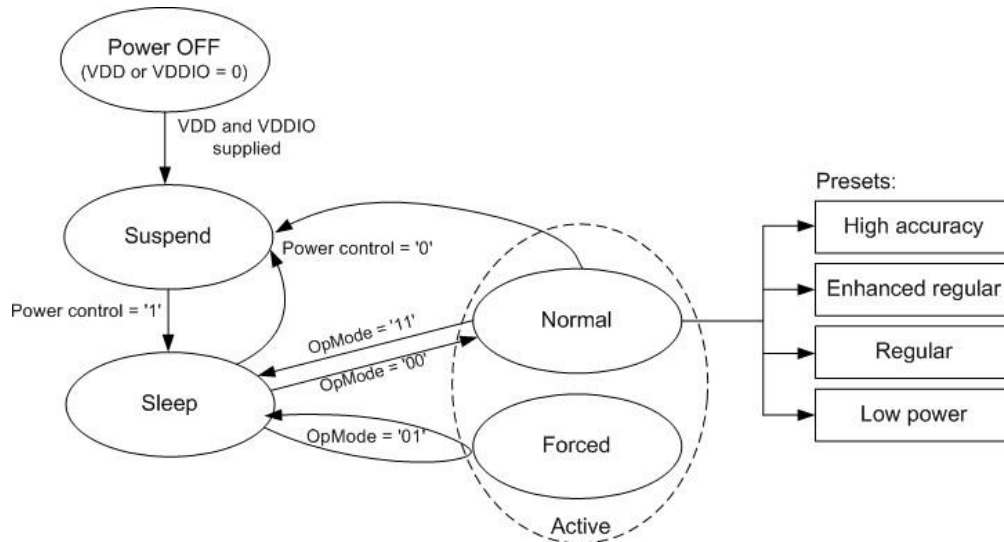

Figure 20: Magnetometer power mode transition diagram

In Active Mode and normal operation, in principle any desired balance between output noise and active time (hence power consumption) can be adjusted by the repetition settings for x/y- axis and z-axis and the output data rate ODR. The average power consumption depends on the ratio of high current phase time (during data acquisition) and low current phase time (between data acquisitions). Hence, the more repetitions are acquired to generate one magnetic field data point, the longer the active time ratio in one sample phase, and the higher the average current. Thanks to longer internal averaging, the noise level of the output data reduces with increasing number of repetitions.

By using forced mode, it is possible to trigger new measurements at any rate. The user can therefore trigger measurements in a shorter interval than it takes for a measurement cycle to complete. If a measurement cycle is not allowed to complete, the resulting data will not be written into the data registers. To prevent this, the manually triggered measurement intervals must not be shorter than the active measurement time which is a function of the selected number of repetitions. The maximum selectable read-out frequency in forced mode can be calculated as follows:

$$f_{\max,ODR} \approx \frac{1}{145\mu s \times nXY + 500\mu s \times nZ + 980\mu s}$$

Hereby nXY is the number of repetitions on X/Y-axis (not the register value) and nZ the number of repetitions on Z-axis (not the register value) (see description of REPXY and REPZ registers in chapter 10.8).

Although the repetition numbers for X/Y and Z axis and the ODR can be adjusted independently and in a wide range, there are four recommended presets (High accuracy preset, Enhanced

regular preset, Regular preset, Low power preset) which reflect the most common usage scenarios, i.e. required output accuracy at a given current consumption, of the magnetometer.

The four presets consist of the below register configurations, which are automatically set by the magnetometer API or driver provided by Bosch Sensortec when a preset is selected. Table 37 shows the recommended presets and the resulting magnetic field output noise and current consumption:

Table 37: Recommended presets for repetitions and output data rates

Preset	Rep. X/Y <i>nXY</i>	Rep. Z <i>nZ</i>	recommended ODR [Hz]	Max ODR in forced mode $f_{max,ODR}$ [Hz]	RMS Noise <i>x/y/z</i> [μ T]	Average current consumption at recommended ODR [mA]
Low power preset	3	3	10	>300	1.0/1.0/1.4	0.17
Regular preset	9	15	10	100	0.6/0.6/0.6	0.5
Enhanced regular preset	15	27	10	60	0.5/0.5/0.5	0.8
High accuracy preset	47	83	20	20	0.3/0.3/0.3	4.9

9.3 Magnetometer output data

9.3.1 Magnetic field data

The representation of magnetic field data is different between X/Y-axis and Z-axis. The width of X- and Y-axis magnetic field data is 13 bits each and stored in two's complement.

DATAX_LSB (0x42) contains 5-bit LSB part [4:0] of the 13 bit output data of the X-channel.

DATAX_MSB (0x43) contains 8-bit MSB part [12:5] of the 13 bit output data of the X-channel.

DATAY_LSB (0x44) contains 5-bit LSB part [4:0] of the 13 bit output data of the Y-channel.

DATAY_MSB (0x45) contains 8-bit MSB part [12:5] of the 13 bit output data of the Y-channel.

The width of the Z-axis magnetic field data is 15 bit word stored in two's complement.

DATAZ_LSB (0x46) contains 7-bit LSB part [6:0] of the 15 bit output data of the Z-channel.

DATAZ_MSB (0x47) contains 8-bit MSB part [14:7] of the 15 bit output data of the Z-channel.

For all axes, temperature compensation on the host is used to get ideally matching sensitivity over the full temperature range. The temperature compensation is based on a resistance measurement of the hall sensor plate. The resistance value is represented by a 14 bit unsigned output word.

RHALL_LSB (0x48) contains 6-bit LSB part [5:0] of the 14 bit output data of the RHALL- channel.

RHALL_MSB (0x49) contains 8-bit MSB part [13:6] of the 14 bit output data of the RHALL- channel.

All signed register values are in two's complement representation. Bits which are marked "reserved" can have different values or can in some cases not be read at all (read will return 0x00 in I²C mode and high-Z in SPI mode).

Data register readout and shadowing is implemented as follows:

After all enabled axes have been measured; complete data packages consisting of DATA_X, DATA_Y, DATA_Z and RHALL are updated at once in the data registers. This way, it is prevented that a following axis is updated while the first axis is still being read (axis mix-up) or that MSB part of an axis is updated while LSB part is being read.

While reading from any data register, data register update is blocked. Instead, incoming new data is written into shadow registers which will be written to data registers after the previous read sequence is completed (i.e. upon stop condition in I²C mode, or CSB going high in SPI mode, respectively). Hence, it is recommended to read out all data at once (0x42 to 0x49 or 0x4A if status bits are also required) with a burst read.

Single bytes or axes can be read out, while in this case it is not assured that adjacent registers are not updated during readout sequence.

The “Data ready status” bit (register 0x48 bit0) is set “1” when the data registers have been updated but the data was not yet read out over digital interface. Data ready is cleared (set “0”) directly after completed read out of any of the data registers and subsequent stop condition (I²C) or lifting of CSB (SPI).

In addition, when enabled the “Data overrun” bit (register 0x4A bit7) turns “1” whenever data registers are updated internally, but the old data was not yet read out over digital interface (i.e. data ready bit was still high). The “Data overrun” bit is cleared when the interrupt status register 0x4A is read out. This function needs to be enabled separately by setting the “Data overrun En” bit (register 0x4D bit7).

Note:

Please also see chapter 10.4 for detailed register descriptions.

9.3.2 Magnetic field data temperature compensation

The raw register values DATA_X, DATA_Y, DATA_Z and RHALL are read out from the host processor using the MAGNETOMETER API/driver which is provided by Bosch Sensortec. The API/driver performs an off-chip temperature compensation and outputs x/y/z magnetic field data in 16 LSB/μT to the upper application layer:

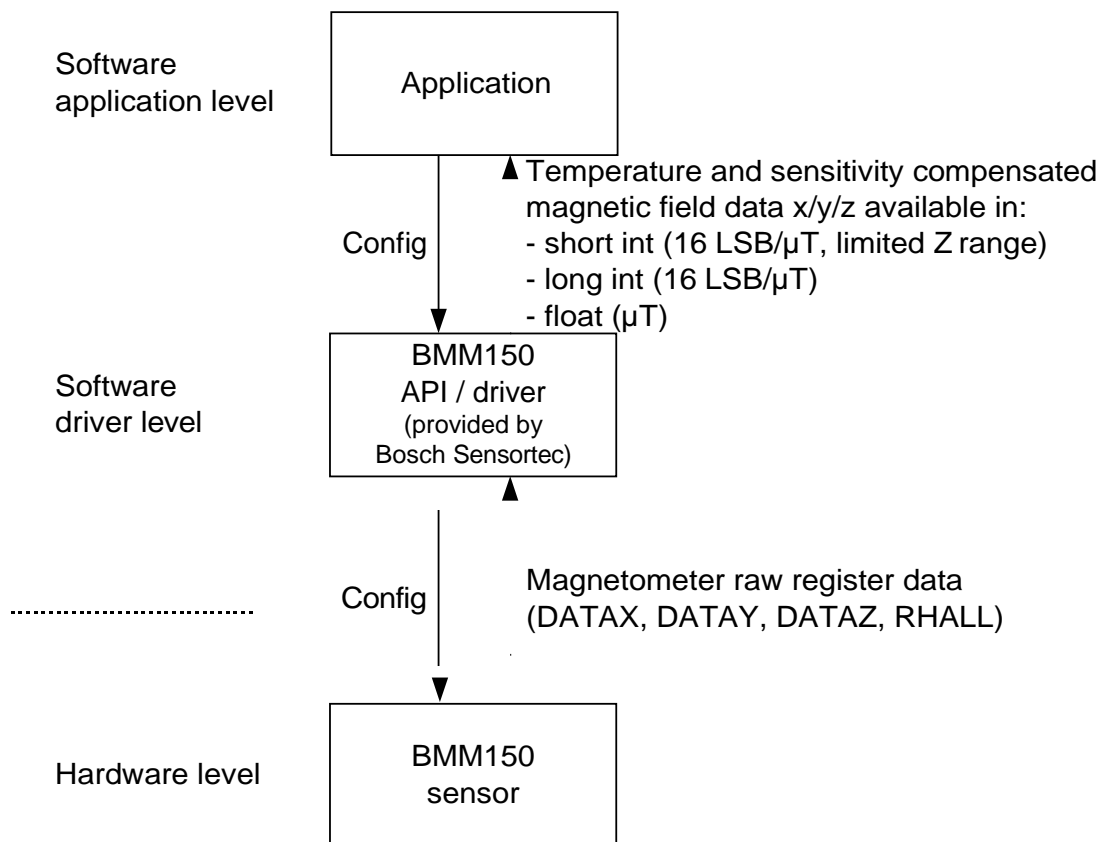

Figure 21: Calculation flow of magnetic field data from raw magnetometer register data

The API/driver performs all calculations using highly optimized fixed-point C-code arithmetic. For platforms that do not support C code, a floating-point formula is available as well.

9.4 Self-test magnetometer

Magnetometer supports two self-tests modes: Normal self-test and advanced self-test.

9.4.1 Normal self test

During normal self-test, the following verifications are performed:

FlipCore signal path is verified by generating signals on-chip. These are processed through the signal path and the measurement result is compared to known thresholds.

- FlipCore (X and Y) connection to ASIC are checked for connectivity and short circuits
- Hall sensor connectivity is checked for open and shorted connections
- Hall sensor signal path and hall sensor element offset are checked for overflow.

To perform a self test, the sensor must first be put into sleep mode (OpMode = "11"). Self-test mode is then entered by setting the bit "Self test" (register 0x4C bit0) to "1". After performing self test, this bit is set back to "0". When self-test is successful, the corresponding self-test result bits are set to "1" ("X-Self-Test" register 0x42 bit0, "Y-Self-Test" register 0x44 bit0, "Z-Self-Test" register 0x46 bit0). If self-test fails for an axis, the corresponding result bit returns "0".

9.4.2 Advanced self test

Advanced self test performs a verification of the Z channel signal path functionality and sensitivity. An on-chip coil wound around the hall sensor can be driven in both directions with a calibrated current to generate a positive or negative field of around 100 μT .

Advanced self test is an option that is active in parallel to the other operation modes. The only difference is that during the active measurement phase, the coil current is enabled. The recommended usage of advanced self test is the following:

1. Set sleep mode
2. Disable X, Y axis
3. Set Z repetitions to desired level
4. Enable positive advanced self test current
5. Set forced mode, readout Z and R channel after measurement is finished
6. Enable negative advanced self test current
7. Set forced mode, readout Z and R channel after measurement is finished
8. Disable advanced self test current (this must be done manually)
9. Calculate difference between the two compensated field values. This difference should be around 200 μ T with some margins.
10. Perform a soft reset of manually restore desired settings

Please refer to the corresponding application note for the exact thresholds to evaluate advanced self-test.

The table below describes how the advanced self-test is controlled:

Table 38: Magnetometer advanced self-test control

(0x4C) Adv.ST <1:0>	Configuration
00b	Normal operation (no self-test), default
01b	Reserved, do not use
10b	Negative on-chip magnetic field generation
11b	Positive on-chip magnetic field generation

The magnetometer API/driver provided by Bosch Sensortec provides a comfortable way to perform both self-tests and to directly obtain the result without further calculations. It is recommended to use this as a reference.

9.5 Non-volatile memory

Some of the memory of the magnetometer is non-volatile memory (NVM). This NVM is pre-programmed in Bosch Sensortec fabrication line and cannot be modified afterwards. It contains trimming data which are required for sensor operation and sensor data compensation, thus it is read out by the magnetometer API/driver during initialization.

9.6 Magnetometer interrupt controller

Four magnetometer based interrupt engines are integrated: Low-Threshold, High-Threshold, Overflow and Data Ready (DRDY). Each interrupt can be enabled independently.

When enabled, an interrupt sets the corresponding status bit in the interrupt status register (0x4A) when its condition is satisfied.

When the "Interrupt Pin Enable" bit (register 0x4E bit6) is set, any occurring activated interrupts are flagged on the magnetometer's INT output pin. By default, the interrupt pin is disabled (high-Z status).

Low-Threshold, High-Threshold and Overflow interrupts are mapped to the INT pin when enabled, Data Ready (DRDY) interrupt is mapped to the DRDY pin of magnetometer when enabled. For High- and Low-Threshold interrupts each axis X/Y/Z can be enabled separately for interrupt detection in the registers “High Int Z en”, “High Int Y en”, “High Int X en”, “Low Int Z en”, “Low Int Y En” and “Low Int X En” in register *0x4D bit5-bit0*. Overflow interrupt is shared for X, Y and Z axis.

When the “Data Ready Pin En” bit (register *0x4E bit7*) is set, the Data Ready (DRDY) interrupt event is flagged on the magnetometer’s DRDY output pin (by default the “Data Ready Pin En” bit is not set and DRDY pin is in high-Z state).

The interrupt status registers are updated together with writing new data into the magnetic field data registers. The status bits for Low-/High-Threshold interrupts are located in register *0x4A*, the Data Ready (DRDY) status flag is located at register *0x48 bit0*.

If an interrupt is disabled, all active status bits and pins are reset after the next measurement was performed.

9.6.1 General features

An interrupt is cleared depending on the selected interrupt mode, which is common to all interrupts. There are two different interrupt modes: non-latched and latched. All interrupts (except Data Ready) can be latched or non-latched. Data Ready (DRDY) is always cleared after readout of data registers ends.

A non-latched interrupt will be cleared on a new measurement when the interrupt condition is not valid anymore, whereas a latched interrupt will stay high until the interrupts status register (*0x4A*) is read out. After reading the interrupt status, both the interrupt status bits and the interrupt pin are reset. The mode is selected by the “Interrupt latch” bit (register *0x4A bit1*), where the default setting of “1” means latched. Figure 22 shows the difference between the modes for the example Low-Threshold interrupt.

INT and DRDY pin polarity can be changed by the “Interrupt polarity” bit (register *0x4E bit0*) and “DR polarity” (register *0x4E bit2*) from the default high active (“1”) to low active (“0”).

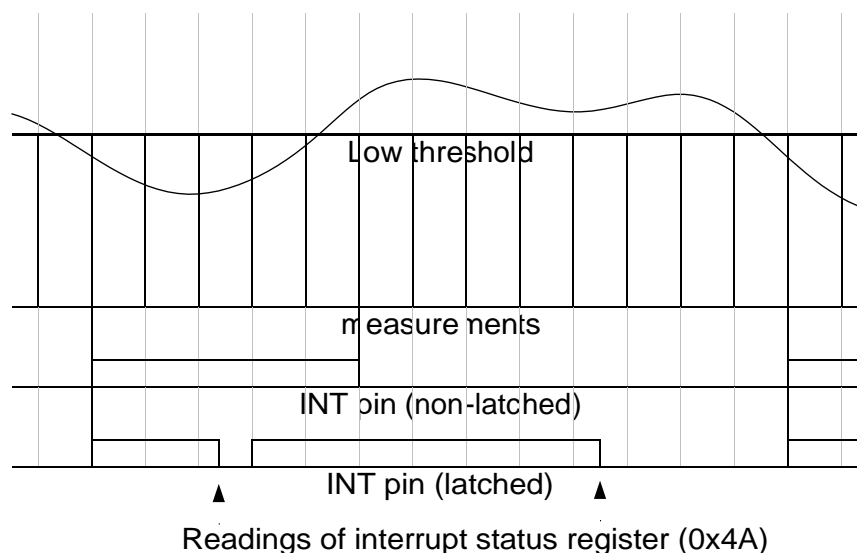

Figure 22: Interrupt latched and non-latched mode

9.6.2 Electrical behavior of magnetic interrupt pins

Both interrupt pins INT and DRDY are push/pull when the corresponding interrupt pin enable bit is set, and are floating (High-Z) when the corresponding interrupt pin enable bit is disabled (default).

9.6.3 Data ready / DRDY interrupt

This interrupt serves for synchronous reading of magnetometer data. It is generated after storing a new set of values (DATA_X, DATA_Y, DATA_Z, RHALL) in the data registers:

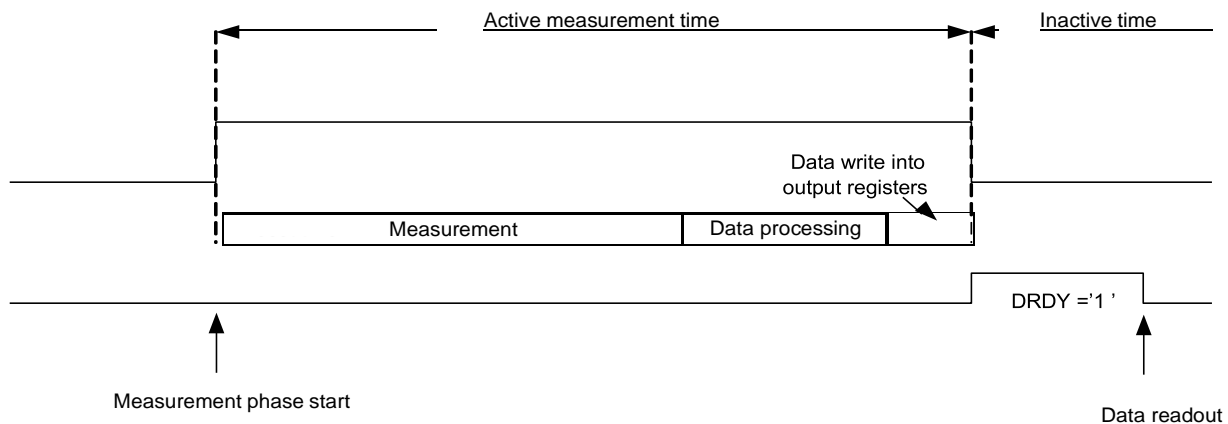

Figure 23: Data acquisition and DRDY operation (DRDY in “high active” polarity)

The interrupt mode of the Data Ready (DRDY) interrupt is fixed to non-latched. It is enabled (disabled) by writing “1” (“0”) to “Data Ready pin En” in register *0x4E bit7*.

DRDY pin polarity can be changed by the “DR polarity” bit (register *0x4E bit2*), from the default high active (“1”) to low active (“0”).

9.6.4 Low-threshold interrupt

When the data registers’ (DATA_X, DATA_Y and DATA_Z) values drop below the threshold level defined by the “Low Threshold register (*0x4F*), the corresponding interrupt status bits for those axes are set (“Low Int X”, “Low Int Y” and “Low Int Z” in register *0x4A*). This is done for each axis independently. Please note that the X and Y axis value for overflow is -4096. However, no interrupt is generated on these values. See chapter 10.7 for more information on overflow.

Hereby, one bit in “Low Threshold” corresponds to roughly 6μT (not exactly, as the raw magnetic field values DATA_X, DATA_Y and DATA_Z are not temperature compensated).

The Low-threshold interrupt is issued on INT pin when one or more values of the data registers DATA_X, DATA_Y and DATA_Z drop below the threshold level defined by the “Low Threshold” register (*0x4F*), and when the axis where the threshold was exceeded is enabled for interrupt generation:

$$\text{Result} = (\text{DATA}_X < \text{“Low Threshold”} \times 16) \text{ AND “Low Int X en” is “0” OR} \\ (\text{DATA}_Y < \text{“Low Threshold”} \times 16) \text{ AND “Low Int Y en” is “0” OR} \\ (\text{DATA}_Z < \text{“Low Threshold”} \times 16) \text{ AND “Low Int Z en” is “0”}$$

Note: Threshold interrupt enable bits (“Low INT [XYZ] en”) are active low and “1” (disabled) by default.

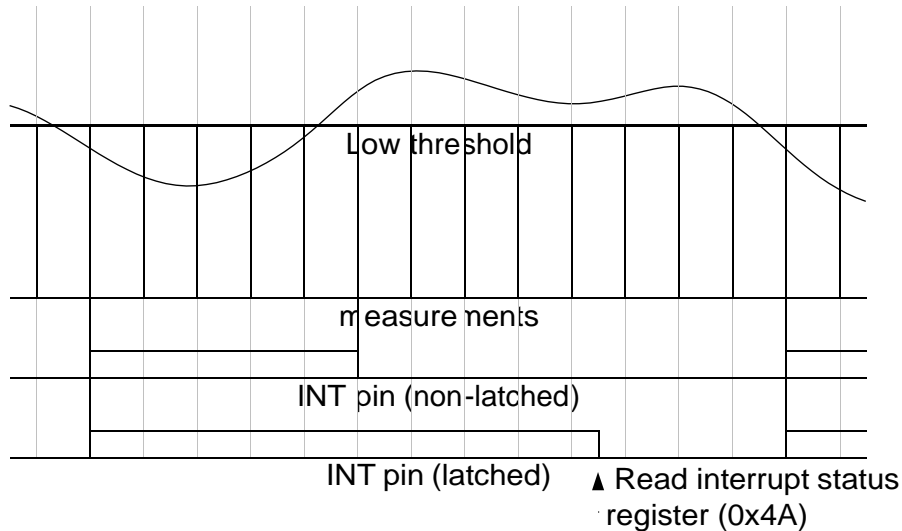

Figure 24: Low-threshold interrupt function

9.6.5 High-threshold interrupt

When the data registers’ (DATA_X, DATA_Y and DATA_Z) values exceed the threshold level defined by the “High Threshold register (0x50), the corresponding interrupt status bits for those axes are set (“High Int X”, “High Int Y” and “High Int Z” in register 0x4A). This is done for each axis independently.

Hereby, one bit in “High Threshold” corresponds to roughly 6μT (not exactly, as the raw magnetic field values DATA_X, DATA_Y and DATA_Z are not temperature compensated).

The High-threshold interrupt is issued on INT pin when one or more values of the data registers DATA_X, DATA_Y and DATA_Z exceed the threshold level defined by the “High Threshold” register (0x50), and when the axis where the threshold was exceeded is enabled for interrupt generation:

$$\text{Result} = (\text{DATA}_X > \text{“High Threshold”} \times 16) \text{ AND “High Int X en” is “0” OR} \\ (\text{DATA}_Y > \text{“High Threshold”} \times 16) \text{ AND “High Int Y en” is “0” OR} \\ (\text{DATA}_Z > \text{“High Threshold”} \times 16) \text{ AND “High Int Z en” is “0”}$$

Note:

Threshold interrupt enable bits (“High INT [XYZ] en”) are active low and “1” (disabled) by default.

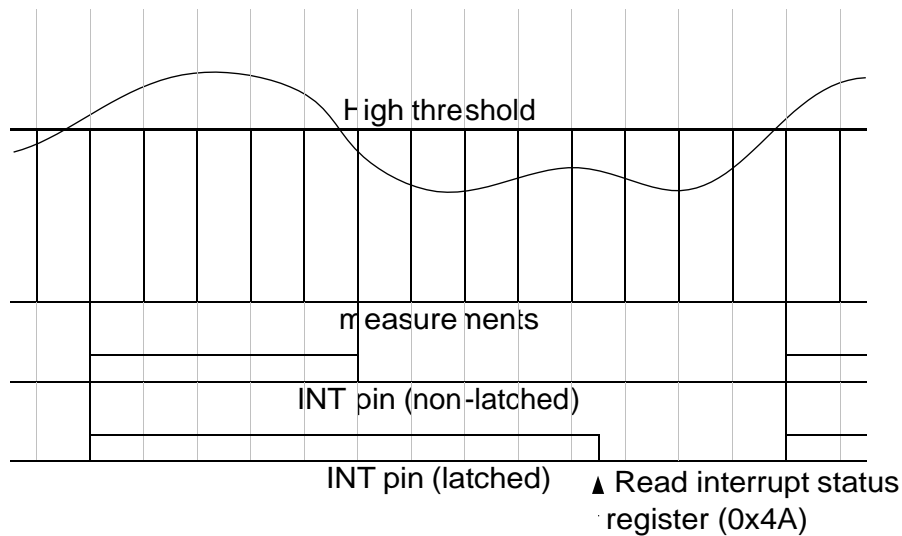

Figure 25: High-threshold interrupt function

9.6.6 Overflow

When a measurement axis had an overflow, the corresponding data register is saturated to the most negative value. For X and Y axis, the data register is set to the value -4096. For the Z axis, the data register is set to the value -16384.

The “Overflow” flag (register *0x4A bit6*) indicates that the measured magnetic field raw data of one or more axes exceeded maximum range of the device. The overflow condition can be flagged on the INT pin by setting the bit “overflow int enable” (register *0x4D bit6*, active high, default value “0”). The channel on which overflow occurred can be determined by assessing the DATA_{X/Y/Z} registers.

10 Register description magnetometer

10.1 General remarks

The entire communication with the device's magnetometer part is performed by reading from and writing to registers. Registers have a width of 8 bits; they are mapped to a common space of 50 addresses from (0x40) up to (0x71). Within the used range there are several registers which are marked as 'reserved'. Any reserved bit is ignored when it is written and no specific value is guaranteed when read. Especially, in SPI mode the SDO pin may stay in high-Z state when reading some of these registers.

Registers with addresses from (0x40) up to (0x4A) are read-only. Any attempt to write to these registers is ignored.

10.2 Register map magnetometer

Register Address	Default Value	bit7	bit6	bit5	bit4	bit3	bit2	bit1	bit0	
0x71	N/A									
0x70	N/A									
0x6F	N/A									
0x6E	N/A									
0x6D	N/A									
0x6C	N/A									
0x6B	N/A									
0x6A	N/A									
0x69	N/A									
0x68	N/A									
0x67	N/A									
0x66	N/A									
0x65	N/A									
0x64	N/A									
0x63	N/A									
0x62	N/A					reserved				
0x61	N/A									
0x60	N/A									
0x5F	N/A									
0x5E	N/A									
0x5D	N/A									
0x5C	N/A									
0x5B	N/A									
0x5A	N/A									
0x59	N/A									
0x58	N/A									
0x57	N/A									
0x56	N/A									
0x55	N/A									
0x54	N/A									
0x53	N/A									
0x52	0x00	REPZ Number Of Repetitions (valid for Z) [7:0]								
0x51	0x00	REPXY Number Of Repetitions (valid for XY) [7:0]								
0x50	0x00	High Threshold [7:0]								
0x4F	0x00	Low Threshold [7:0]								
0x4E	0x07	Data Ready Pin En	Interrupt Pin En	Channel Z	Channel Y	Channel X	DR Polarity	Interrupt Latch	Interrupt Polarity	
0x4D	0x3F	Data Overrun En	Overflow Int En	High Int Z en	High Int Y en	High Int X en	Low Int Z en	Low Int Y en	Low Int X en	
0x4C	0x06	Adv. ST [1:0]			Data Rate [2:0]		Opmode [1:0]		Self Test	
0x4B	0x01	Soft Reset '1'	fixed '0'	fixed '0'	fixed '0'	fixed '0'	SPI3en	Soft Reset '1'	Power Control Bit	
0x4A	0x00	Data Overrun	Overflow	High Int Z	High Int Y	High Int X	Low Int Z	Low Int Y	Low Int X	
0x49	N/A	RHALL [13:6] MSB								
0x48	N/A	RHALL [5:0] LSB						fixed '0'	Data Ready Status	
0x47	N/A	DATA Z [14:7] MSB				DATA Z [6:0] LSB				Z-Self-Test
0x46	N/A	DATA Y [4:0] LSB				DATA X [12:5] MSB				Y-Self-Test
0x45	N/A	DATA Y [4:0] LSB				DATA X [12:5] MSB				X-Self-Test
0x44	N/A	DATA Y [4:0] LSB				DATA X [12:5] MSB				X-Self-Test
0x43	N/A	DATA Y [4:0] LSB				DATA X [12:5] MSB				X-Self-Test
0x42	N/A	DATA X [4:0] LSB				reserved				
0x41	N/A	reserved								
0x40	0x32	Chip ID = 0x32 (can only be read if power control bit =1*)								

	w/r
	w/r accessible in suspend mode
	read only
	reserved

10.3 Chip ID magnetometer

MAG Register (0x40)

Chip ID contains the magnetometer chip identification number, which is 0x32. This number can only be read if the power control bit (register 0x4B bit0) is enabled.

Table 39: Chip identification number, register (0x40)

Bit 7	Bit 6	Bit 5	Bit 4	Bit 3	Bit 2	Bit 1	Bit 0
0	0	1	1	0	0	1	0

MAG Register (0x41) is reserved

10.4 Magnetic field data

MAG Register (0x42)

Register (0x42) contains the LSB part of x-axis magnetic field data and the self-test result flag for the x-axis.

Table 40: LSB part of x-axis magnetic field, register (0x42)

(0x42) Bit	Name	Description
Bit 7	DATAX_lsb <4>	Bit 4 of x-axis magnetic field data
Bit 6	DATAX_lsb <3>	Bit 3 of x-axis magnetic field data
Bit 5	DATAX_lsb <2>	Bit 2 of x-axis magnetic field data
Bit 4	DATAX_lsb <1>	Bit 1 of x-axis magnetic field data
Bit 3	DATAX_lsb <0>	Bit 0 of x-axis magnetic field data = x LSB
Bit 2	-	(fixed to 0)
Bit 1	-	(fixed to 0)
Bit 0	SelfTestX	Self-test result flag for x-axis, default is "1"

MAG Register (0x43)

Register (0x43) contains the MSB part of x-axis magnetic field data.

Table 41: MSB part of x-axis magnetic field, register (0x43)

(0x43) Bit	Name	Description
Bit 7	DATAX_msb <12>	Bit 12 of x-axis magnetic field data = x MSB
Bit 6	DATAX_msb <11>	Bit 11 of x-axis magnetic field data
Bit 5	DATAX_msb <10>	Bit 10 of x-axis magnetic field data
Bit 4	DATAX_msb <9>	Bit 9 of x-axis magnetic field data
Bit 3	DATAX_msb <8>	Bit 8 of x-axis magnetic field data
Bit 2	DATAX_msb <7>	Bit 7 of x-axis magnetic field data
Bit 1	DATAX_msb <6>	Bit 6 of x-axis magnetic field data
Bit 0	DATAX_msb <5>	Bit 5 of x-axis magnetic field data

MAG Register (0x44)

Register (0x44) contains the LSB part of y-axis magnetic field data and the self-test result flag for the y-axis.

Table 42: LSB part of y-axis magnetic field, register (0x44)

(0x44) Bit	Name	Description
Bit 7	DATA _Y _lsb <4>	Bit 4 of y-axis magnetic field data
Bit 6	DATA _Y _lsb <3>	Bit 3 of y-axis magnetic field data
Bit 5	DATA _Y _lsb <2>	Bit 2 of y-axis magnetic field data
Bit 4	DATA _Y _lsb <1>	Bit 1 of y-axis magnetic field data
Bit 3	DATA _Y _lsb <0>	Bit 0 of y-axis magnetic field data = y LSB
Bit 2	-	(fixed to 0)
Bit 1	-	(fixed to 0)
Bit 0	SelfTestY	Self-test result flag for y-axis, default is "1"

MAG Register (0x45)

Register (0x45) contains the MSB part of y-axis magnetic field data.

Table 43: MSB part of y-axis magnetic field, register (0x45)

(0x45) Bit	Name	Description
Bit 7	DATA _Y _msb <12>	Bit 12 of y-axis magnetic field data = y MSB
Bit 6	DATA _Y _msb <11>	Bit 11 of y-axis magnetic field data
Bit 5	DATA _Y _msb <10>	Bit 10 of y-axis magnetic field data
Bit 4	DATA _Y _msb <9>	Bit 9 of y-axis magnetic field data
Bit 3	DATA _Y _msb <8>	Bit 8 of y-axis magnetic field data
Bit 2	DATA _Y _msb <7>	Bit 7 of y-axis magnetic field data
Bit 1	DATA _Y _msb <6>	Bit 6 of y-axis magnetic field data
Bit 0	DATA _Y _msb <5>	Bit 5 of y-axis magnetic field data

MAG Register (0x46)

Register (0x46) contains the LSB part of z-axis magnetic field data and the self-test result flag for the z-axis.

Table 44: LSB part of z-axis magnetic field, register (0x46)

(0x46) Bit	Name	Description
Bit 7	DATA _Z _lsb <6>	Bit 6 of z-axis magnetic field data
Bit 6	DATA _Z _lsb <5>	Bit 5 of z-axis magnetic field data
Bit 5	DATA _Z _lsb <4>	Bit 4 of z-axis magnetic field data
Bit 4	DATA _Z _lsb <3>	Bit 3 of z-axis magnetic field data
Bit 3	DATA _Z _lsb <2>	Bit 2 of z-axis magnetic field data
Bit 2	DATA _Z _lsb <1>	Bit 1 of z-axis magnetic field data
Bit 1	DATA _Z _lsb <0>	Bit 0 of z-axis magnetic field data = z LSB
Bit 0	SelfTestZ	Self-test result flag for z-axis, default is "1"

MAG Register (0x47)

Register (0x47) contains the MSB part of z-axis magnetic field data.

Table 45: MSB part of z-axis magnetic field, register (0x47)

(0x47) Bit	Name	Description
Bit 7	DATAZ_msb <14>	Bit 14 of y-axis magnetic field data = z MSB
Bit 6	DATAZ_msb <13>	Bit 13 of y-axis magnetic field data
Bit 5	DATAZ_msb <12>	Bit 12 of y-axis magnetic field data
Bit 4	DATAZ_msb <11>	Bit 11 of y-axis magnetic field data
Bit 3	DATAZ_msb <10>	Bit 10 of y-axis magnetic field data
Bit 2	DATAZ_msb <9>	Bit 9 of y-axis magnetic field data
Bit 1	DATAZ_msb <8>	Bit 8 of y-axis magnetic field data
Bit 0	DATAZ_msb <7>	Bit 7 of y-axis magnetic field data

MAG Register (0x48)

Register (0x48) contains the LSB part of hall resistance and the Data Ready (DRDY) status bit.

Table 46: LSB part of hall resistance, register (0x48)

(0x48) Bit	Name	Description
Bit 7	RHALL_lsb <5>	Bit 5 of hall resistance
Bit 6	RHALL_lsb <4>	Bit 4 of hall resistance
Bit 5	RHALL_lsb <3>	Bit 3 of hall resistance
Bit 4	RHALL_lsb <2>	Bit 2 of hall resistance
Bit 3	RHALL_lsb <1>	Bit 1 of hall resistance
Bit 2	RHALL_lsb <0>	Bit 0 of hall resistance = RHALL LSB
Bit 1	-	(fixed to 0)
Bit 0	Data Ready Status	Data ready (DRDY) status bit

MAG Register (0x49)

Register (0x49) contains the MSB part of hall resistance.

Table 47: MSB part of hall resistance, register (0x49)

(0x49) Bit	Name	Description
Bit 7	RHALL_msb <13>	Bit 13 of hall resistance = RHALL MSB
Bit 6	RHALL_msb <12>	Bit 12 of hall resistance
Bit 5	RHALL_msb <11>	Bit 11 of hall resistance
Bit 4	RHALL_msb <10>	Bit 10 of hall resistance
Bit 3	RHALL_msb <9>	Bit 9 of hall resistance
Bit 2	RHALL_msb <8>	Bit 8 of hall resistance
Bit 1	RHALL_msb <7>	Bit 7 of hall resistance
Bit 0	RHALL_msb <6>	Bit 6 of hall resistance

10.5 Interrupt status register magnetometer

MAG Register (0x4A)

Register (0x4A) contains the states of all interrupts.

Table 48: Interrupt status, register (0x4A)

(0x4A) Bit	Name	Description
Bit 7	Data overrun	Data overrun status flag
Bit 6	Overflow	Overflow status flag
Bit 5	High Int Z	High-Threshold interrupt z-axis status flag
Bit 4	High Int Y	High-Threshold interrupt y-axis status flag
Bit 3	High Int X	High-Threshold interrupt x-axis status flag
Bit 2	Low Int Z	Low-Threshold interrupt z-axis status flag
Bit 1	Low Int Y	Low-Threshold interrupt y-axis status flag
Bit 0	Low Int X	Low-Threshold interrupt x-axis status flag

10.6 Power and operation modes, self-test, data output rate control registers

MAG Register (0x4B)

Register (0x4B) contains control bits for power control, soft reset and interface SPI mode selection. This special control register is also accessible in suspend mode.

Soft reset is executed when both bits (register 0x4B bit7 and bit1) are set “1”. Soft reset does not execute a full POR sequence, but all registers are reset except for the “trim” registers above register 0x54 and the power control register (0x4B). Soft reset always brings the device into sleep mode. When device is in the suspend mode, soft reset is ignored and the device remains in suspend mode. The two “Soft Reset” bits are reset to “0” automatically after soft reset was completed. To perform a full POR reset, bring the device into suspend and then back into sleep mode.

When SPI mode is selected, the “SPI3En” bit enables SPI 3-wire mode when set “1”. When “SPI3En” is set “0” (default), 4-wire SPI mode is selected.

Setting the “Power Control bit” to “1” brings the device up from Suspend mode to Sleep mode, when “Power Control bit” is set “0” the device returns to Suspend mode (see chapter 9.2 for details of magnetometer power modes).

Table 49: Power control, soft reset and SPI mode control register (0x4B)

(0x4B) Bit	Name	Description
Bit 7	Soft Reset ‘1’	One of the soft reset trigger bits.
Bit 6	-	(fixed to 0)
Bit 5	-	(fixed to 0)
Bit 4	-	(fixed to 0)
Bit 3	-	(fixed to 0)
Bit 2	SPI3en	Enable bit for SPI3 mode
Bit 1	Soft Reset ‘1’	One of the soft reset trigger bits.
Bit 0	Power Control bit	When set to “0”, suspend mode is selected

MAG Register (0x4C)

Register (0x4C) contains control bits for operation mode, output data rate and self-test.

The two “Adv. ST” bits control the on-chip advanced self-test (see chapter 9.4 for details of the magnetometer advanced self-test).

The three “Data rate” bits control the magnetometer output data rate according to below Table 51.

The two “Opmode” bits control the operation mode according to below Table 52 (see chapter 9.2 for a detailed description of magnetometer power modes).

Table 50: Operation mode, output data rate and self-test control register (0x4C)

(0x4C) Bit	Name	Description
Bit 7	Adv. ST <1>	Advanced self-test control bit 1
Bit 6	Adv. ST <0>	Advanced self-test control bit 0
Bit 5	Data rate <2>	Data rate control bit 2
Bit 4	Data rate <1>	Data rate control bit 1
Bit 3	Data rate <0>	Data rate control bit 0
Bit 2	Opmode <1>	Operation mode control bit 1
Bit 1	Opmode <0>	Operation mode control bit 0
Bit 0	Self Test	Normal self-test control bit

Three “Data rate” bits control the output data rate (ODR) of the magnetometer part:

Table 51: Output data rate (ODR) setting (0x4C)

(0x4C) Data rate <2:0>	Magnetometer output data rate (ODR) [Hz]
000b	10 (default)
001b	2
010b	6
011b	8
100b	15
101b	20
110b	25
111b	30

Two “Opmode” bits control the operation mode of the magnetometer part:

Table 52: Operation mode setting (0x4C)

(0x4C) Opmode <1:0>	Magnetometer operation mode ⁹
00b	Normal mode
01b	Forced mode
10b	Reserved, do not use
11b	Sleep Mode

10.7 Interrupt and axis enable settings control registers

MAG Register (0x4D)

Register (0x4D) contains control bits for interrupt settings. (Also refer to chapter 9.6 for the details of magnetometer interrupt operation).

Table 53: Interrupt settings control register (0x4D)

(0x4D) Bit	Name	Description
Bit 7	Data Overrun En	Enables data overrun indication in the “Data Overrun” flag (active high, default is “0” disabled)
Bit 6	Overflow Int En	Activates mapping of Overflow flag status to the INT pin (active high, default is “0” disabled)
Bit 5	High Int Z En	Enables the z-axis detection for High-Threshold interrupts (active low, default is “1” disabled)
Bit 4	High Int Y En	Enables the y-axis detection for High-Threshold interrupts (active low, default is “1” disabled)
Bit 3	High Int X En	Enables the x-axis detection for High-Threshold interrupts (active low, default is “1” disabled)
Bit 2	Low Int Z En	Enables the z-axis detection for Low-Threshold interrupts (active low, default is “1” disabled)
Bit 1	Low Int Y En	Enables the y-axis detection for Low-Threshold interrupts (active low, default is “1” disabled)
Bit 0	Low Int X En	Enables the x-axis detection for Low-Threshold interrupts (active low, default is “1” disabled)

⁹ See chapter 9.2 for a detailed description of magnetometer power modes.

MAG Register (0x4E)

Register (0x4E) contains control bits interrupt settings and axes enable bits. (Also refer to chapter 9.6 for the details of magnetometer interrupt operation). If a magnetic measurement channel is disabled, its last measured magnetic output values will remain in the data registers. If the Z channel is disabled, the resistance measurement will also be disabled and the resistance output value will be set to zero. If interrupts are set to trigger on an axis that has been disabled, these interrupts will still be asserted based on the last measured value.

Table 54: Interrupt settings and axes enable bits control register (0x4E)

(0x4E) Bit	Name	Description
Bit 7	Data Ready Pin En	Enables data ready status mapping on DRDY pin (active high, default is "0" disabled)
Bit 6	Interrupt Pin En	Enables interrupt status mapping on INT pin (active high, default is "0" disabled)
Bit 5	Channel Z	Enable z-axis and resistance measurement (active low, default is "0" enabled)
Bit 4	Channel Y	Enable y-axis (active low, default is "0" enabled)
Bit 3	Channel X	Enable x-axis (active low, default is "0" enabled)
Bit 2	DR Polarity	Data ready (DRDY) pin polarity ("0" is active low, "1" is active high, default is "1" active high)
Bit 1	Interrupt Latch	Interrupt latching ("0" means non-latched - interrupt pin is on as long as the condition is fulfilled, "1" means latched - interrupt pin is on until interrupt status register 0x4A is read, default is "1" latched)
Bit 0	Interrupt Polarity	Interrupt pin INT polarity selection ("1" – is active high, "0" is active low, default is "1" active high)

MAG Register (0x4F)

Register (0x4F) contains the Low-Threshold interrupt threshold setting. (Also refer to chapter 9.6 for the details of magnetometer interrupt operation and the threshold setting).

Table 55: Low-threshold interrupt threshold setting control register (0x4F)

(0x4F) Bit	Name	Description
Bit 7	LowThreshold <7>	Bit 7 of Low-Threshold interrupt threshold setting
Bit 6	LowThreshold <6>	Bit 6 of Low-Threshold interrupt threshold setting
Bit 5	LowThreshold <5>	Bit 5 of Low-Threshold interrupt threshold setting
Bit 4	LowThreshold <4>	Bit 4 of Low-Threshold interrupt threshold setting
Bit 3	LowThreshold <3>	Bit 3 of Low-Threshold interrupt threshold setting
Bit 2	LowThreshold <2>	Bit 2 of Low-Threshold interrupt threshold setting
Bit 1	LowThreshold <1>	Bit 1 of Low-Threshold interrupt threshold setting
Bit 0	LowThreshold <0>	Bit 0 of Low-Threshold interrupt threshold setting

MAG Register (0x50)

Register (0x50) contains the High-Threshold interrupt threshold setting. (Also refer to chapter 9.6 for the details of magnetometer interrupt operation and the threshold setting).

Table 56: High-threshold interrupt threshold setting control register (0x4F)

(0x50) Bit	Name	Description
Bit 7	HighThreshold <7>	Bit 7 of High-Threshold interrupt threshold setting
Bit 6	HighThreshold <6>	Bit 6 of High-Threshold interrupt threshold setting
Bit 5	HighThreshold <5>	Bit 5 of High-Threshold interrupt threshold setting
Bit 4	HighThreshold <4>	Bit 4 of High-Threshold interrupt threshold setting
Bit 3	HighThreshold <3>	Bit 3 of High-Threshold interrupt threshold setting
Bit 2	HighThreshold <2>	Bit 2 of High-Threshold interrupt threshold setting
Bit 1	HighThreshold <1>	Bit 1 of High-Threshold interrupt threshold setting
Bit 0	HighThreshold <0>	Bit 0 of High-Threshold interrupt threshold setting

10.8 Number of repetitions control registers

MAG Register (0x51)

Register (0x51) contains the number of repetitions for x/y-axis. Table 58 below shows the number of repetitions resulting out of the register configuration. The performed number of repetitions n_{XY} can be calculated from unsigned register value as $n_{XY} = 1 + 2 \times \text{REP}_{XY}$ as shown below, where b7-b0 are the bits 7 to 0 of register 0x51:

$$\begin{aligned}
 n_{XY} &= 1 + 2 \cdot (b_7 \cdot 2^7 + b_6 \cdot 2^6 + b_5 \cdot 2^5 + b_4 \cdot 2^4 + b_3 \cdot 2^3 + b_2 \cdot 2^2 + b_1 \cdot 2^1 + b_0 \cdot 2^0) \\
 &= 1 + 2 \cdot (\text{REP}_{XY})
 \end{aligned}$$

Table 57: X/y-axis repetitions control register (0x51)

(0x51) Bit	Name	Description
Bit 7	REPXY <7>	Bit 7 of number of repetitions (valid for XY)
Bit 6	REPXY <6>	Bit 6 of number of repetitions (valid for XY)
Bit 5	REPXY <5>	Bit 5 of number of repetitions (valid for XY)
Bit 4	REPXY <4>	Bit 4 of number of repetitions (valid for XY)
Bit 3	REPXY <3>	Bit 3 of number of repetitions (valid for XY)
Bit 2	REPXY <2>	Bit 2 of number of repetitions (valid for XY)
Bit 1	REPXY <1>	Bit 1 of number of repetitions (valid for XY)
Bit 0	REPXY <0>	Bit 0 of number of repetitions (valid for XY)

Table 58: Numbers of repetition for x/y-axis depending on value of register (0x51)

(0x51) register value (binary)	(0x51) register value (hex)	Number of repetitions for x- and y-axis each
00000000b	0x00h	1
00000001b	0x01h	3
00000010b	0x02h	5
00000011b	0x03h	7
...		...
11111111b	0xFFh	511

MAG Register (0x52)

Register (0x52) contains the number of repetitions for z-axis. Table 60 below shows the number of repetitions resulting out of the register configuration. The performed number of repetitions n_Z can be calculated from unsigned register value as $n_Z = 1 + REPZ$ as shown below, where b_7 - b_0 are the bits 7 to 0 of register 0x52:

$$n_Z = 1 + 1 \cdot (b_7 \cdot 2^7 + b_6 \cdot 2^6 + b_5 \cdot 2^5 + b_4 \cdot 2^4 + b_3 \cdot 2^3 + b_2 \cdot 2^2 + b_1 \cdot 2^1 + b_0 \cdot 2^0)$$

$$= 1 + REPZ$$

Table 59: Z-axis repetitions control register (0x52)

(0x52) Bit	Name	Description
Bit 7	REPZ <7>	Bit 7 of number of repetitions (valid for Z)
Bit 6	REPZ <6>	Bit 6 of number of repetitions (valid for Z)
Bit 5	REPZ <5>	Bit 5 of number of repetitions (valid for Z)
Bit 4	REPZ <4>	Bit 4 of number of repetitions (valid for Z)
Bit 3	REPZ <3>	Bit 3 of number of repetitions (valid for Z)
Bit 2	REPZ <2>	Bit 2 of number of repetitions (valid for Z)
Bit 1	REPZ <1>	Bit 1 of number of repetitions (valid for Z)
Bit 0	REPZ <0>	Bit 0 of number of repetitions (valid for Z)

Table 60: Numbers of repetition for z-axis depending on value of register (0x52)

(0x52) register value (binary)	(0x52) register value (hex)	Number of repetitions for z-axis
00000000b	0x00h	1
00000001b	0x01h	2
00000010b	0x02h	3
00000011b	0x03h	4
...		...
11111111b	0xFFh	256

11 Digital interface of the device

The BMX055 supports two serial digital interface protocols for communication as a slave with a host device: SPI (4-wire and 3-wire) and I²C. The active interface is selected by the state of the Pin#07 (PS) 'protocol select' pin: 'GND' ('VDDIO') selects SPI (I²C). For details please refer to section 11.

By default, SPI operates in the standard 4-wire configuration. It can be re-configured by software to work in 3-wire mode instead of standard 4-wire mode.

Both digital interfaces share partly the same pins. Additionally each inertial sensor (accelerometer and gyroscope) provides specific interface pins which allow the user to operate the inertial sensors independently of each other. The mapping for each interface and each inertial sensor is given in the following table:

Table 61: Mapping of the interface pins

Pin #	Name	use w/ SPI	use w/ I ² C	Description
17	SDOAM	SDOAM	address	SPI: Accel&Mag Data Output (4-wire mode) I ² C: Used to set LSB of Accel&Mag I ² C address
12	SDOG	SDOG	address	SPI: Gyro Data Output (4-wire mode) I ² C: Used to set LSB of Gyro I ² C address
11	SDx	SDI	SDA	SPI: Data In (4-wire mode) & Data In/Out (3-wire mode) I ² C: Serial Data
16	CSBA	CSBA	unused	SPI: Accel Chip Select (enable)
5	CSBG	CSBG	unused	SPI: Gyro Chip Select (enable)
20	CSBM	CSBM	address	SPI:Mag Chip Select(enable) I ² C: Used to set LSB of Mag I ² C address
9	SCx	SCK	SCL	SPI: Serial Clock SCK I ² C: Serial Clock SCL

The following table shows the electrical specifications of the interface pins:

Table 62: Electrical specification of the interface pins

Parameter	Symbol	Condition	Min	Typ	Max	Units
Pull-up Resistance, CSB pin	R _{up}	Internal Pull-up Resistance to VDDIO	75	100	125	kΩ
Input Capacitance	C _{in}			5	10	pF
I ² C Bus Load Capacitance (max. drive capability)	C _{I2C_Load}				400	pF

11.1 Serial peripheral interface (SPI)

The timing specification for SPI of the BMX055 is given in the following table:

Table 63: SPI timing

Parameter	Symbol	Condition	Min	Max	Units
Clock Frequency	f_{SPI}	Max. Load on SDI or SDO = 25pF, $V_{\text{DDIO}} \geq 1.62\text{V}$		10	MHz
		$V_{\text{DDIO}} < 1.62\text{V}$		7.5	MHz
SCK Low Pulse	t_{SCKL}		20		ns
SCK High Pulse	t_{SCKH}		20		ns
SDI Setup Time	$t_{\text{SDI_setup}}$		20		ns
SDI Hold Time	$t_{\text{SDI_hold}}$		20		ns
SDO Output Delay	$t_{\text{SDO_OD}}$	Load = 25pF, $V_{\text{DDIO}} \geq 1.62\text{V}$		30	ns
		Load = 25pF, $V_{\text{DDIO}} < 1.62\text{V}$		50	ns
		Load = 250pF, $V_{\text{DDIO}} > 2.4\text{V}$		40	ns
CSB Setup Time	$t_{\text{CSB_setup}}$		20		ns
CSB Hold Time	$t_{\text{CSB_hold}}$		40		ns
Idle time between write accesses, normal mode, standby mode, low-power mode 2	$t_{\text{IDLE_wacc_nm}}$		2		μs
Idle time between write accesses, suspend mode, low-power mode 1	$t_{\text{IDLE_wacc_sum}}$		450		μs

The following figure shows the definition of the SPI timings:

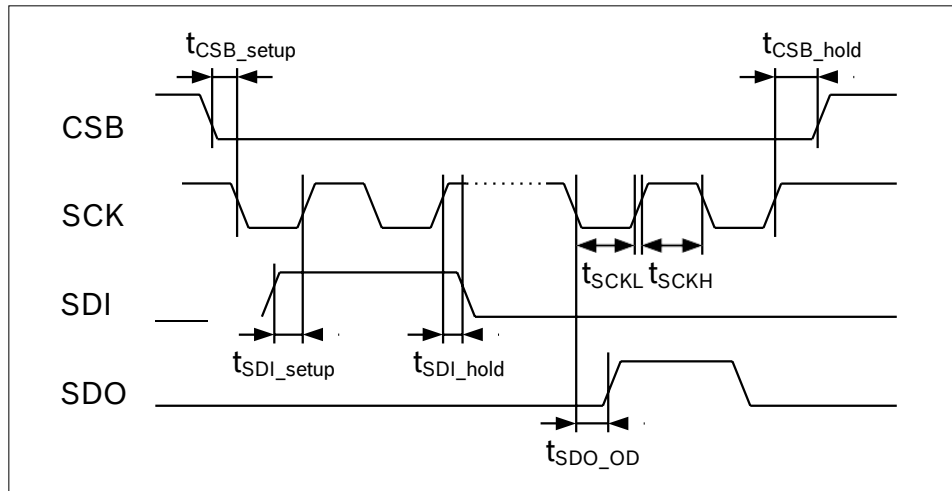

Figure 26: SPI timing diagram

The SPI interface of the BMX055 is compatible with two modes, '00' and '11'. The automatic selection between [CPOL = '0' and CPHA = '0'] and [CPOL = '1' and CPHA = '1'] is controlled based on the value of SCK after a falling edge of CSB (A,G or M).

Two configurations of the SPI interface are supported by the BMX055: 4-wire and 3-wire. The same protocol is used by both configurations. The device operates in 4-wire configuration by default. It can be switched to 3-wire configuration by writing '1' to (ACC 0x34) *spi3* and to (GYR 0x34) *spi3*. Pin SDI is used as the common data pin in 3-wire configuration.

For single byte read as well as write operations, 16-bit protocols are used. The BMX055 also supports multiple-byte read operations.

In SPI 4-wire configuration CSB (A,G or M - chip select low active), SCK (serial clock), SDI (serial data input), and SDO (AM or G - serial data output) pins are used. The communication starts when the CSB (1 or 2) is pulled low by the SPI master and stops when CSB (A,G or M) is pulled high. SCK is also controlled by SPI master. SDI and SDO (AM or G) are driven at the falling edge of SCK and should be captured at the rising edge of SCK.

The basic write operation waveform for 4-wire configuration is depicted in Figure 27. During the entire write cycle SDO remains in high-impedance state.

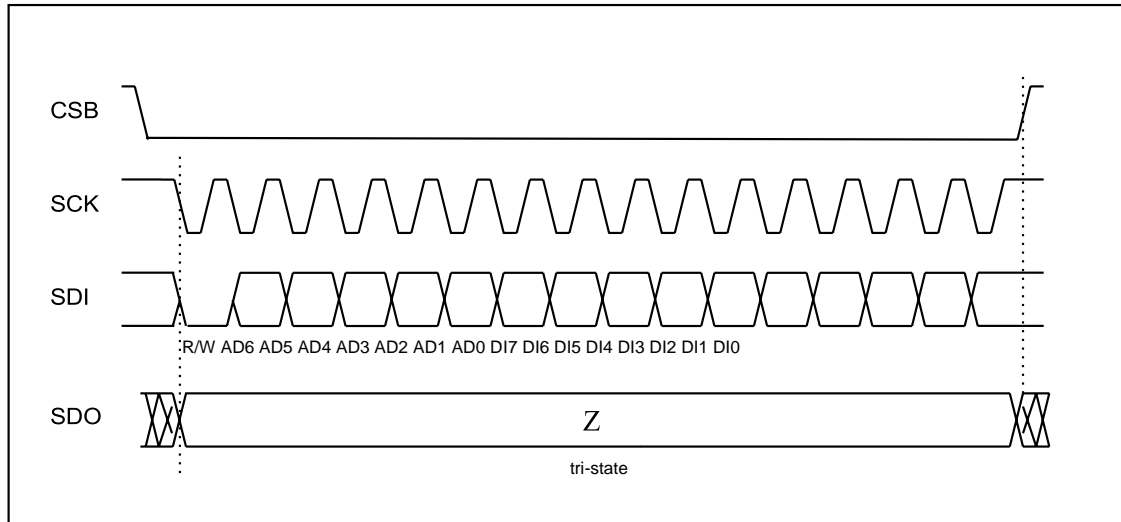

Figure 27: 4-wire basic SPI write sequence (mode '11')

The basic read operation waveform for 4-wire configuration is depicted in Figure 28:

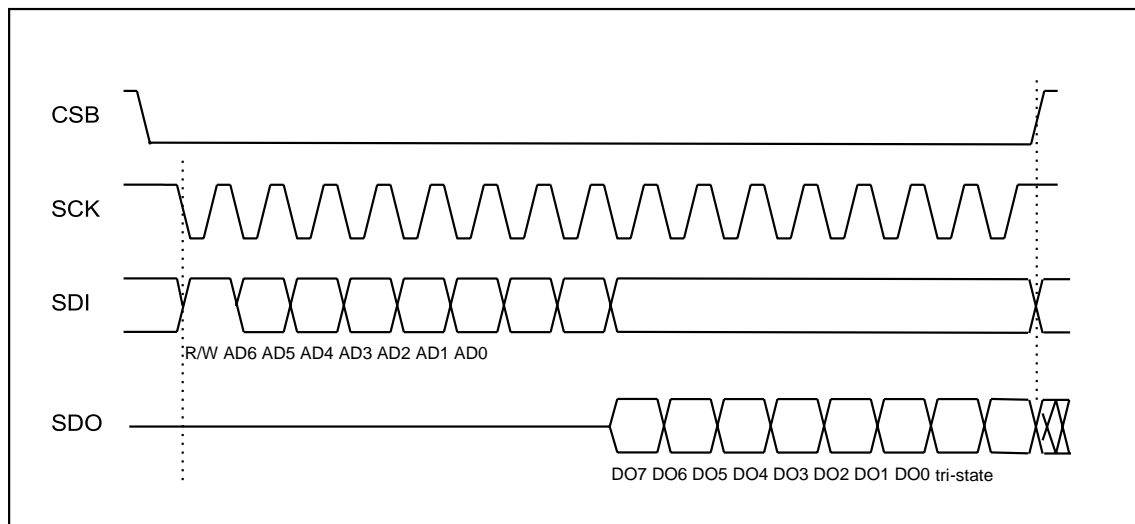

Figure 28: 4-wire basic SPI read sequence (mode '11')

The data bits are used as follows:

Bit0: Read/Write bit. When 0, the data SDI is written into the chip. When 1, the data SDO from the chip is read.

Bit1-7: Address AD(6:0).

Bit8-15: when in write mode, these are the data SDI, which will be written into the address. When in read mode, these are the data SDO, which are read from the address.

Multiple read operations are possible by keeping CSB low and continuing the data transfer. Only the first register address has to be written. Addresses are automatically incremented after each read access as long as CSB stays active low.

The principle of multiple read is shown in Figure 29:

Start	Control byte							Data byte							Data byte							Data byte							Stop																	
	RW	Register address (02h)						Data register - address 02h							Data register - address 03h							Data register - address 04h																								
CSB = 0	1	0	0	0	0	0	1	0	X	X	X	X	X	X	X	X	X	X	X	X	X	X	X	X	X	X	X	X	X	X	X	X	X	X	X	X	X	X	X	X	X	X	X	X	X	CSB = 1

Figure 29: SPI multiple read

In SPI 3-wire configuration CSB (A,G or M - chip select low active), SCK (serial clock), and SDI (serial data input and output) pins are used. The communication starts when the CSB is pulled low by the SPI master and stops when CSB is pulled high. SCK is also controlled by SPI master. SDI is driven (when used as input of the device) at the falling edge of SCK and should be captured (when used as the output of the device) at the rising edge of SCK.

The protocol as such is the same in 3-wire configuration as it is in 4-wire configuration. The basic operation wave-form (read or write access) for 3-wire configuration is depicted in Figure 30.

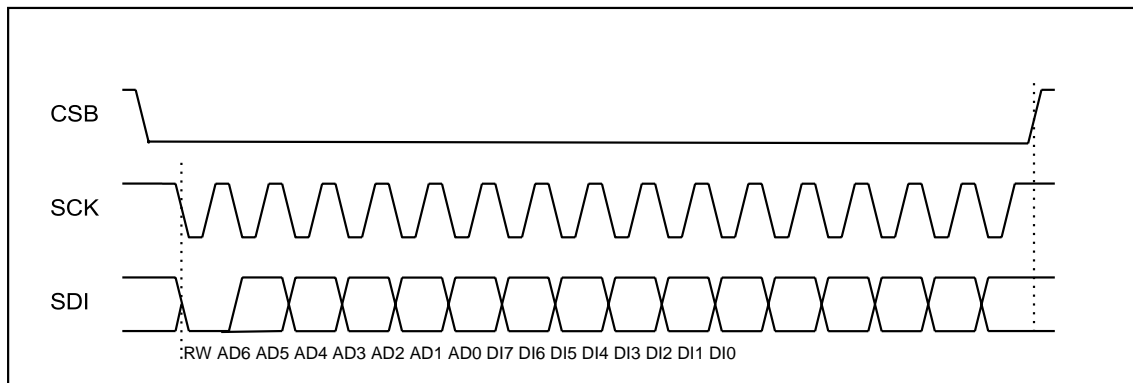

Figure 30: 3-wire basic SPI read or write sequence (mode '11')

11.2 Inter-Integrated Circuit (I²C)

The I²C bus uses SCL (= SCx pin, serial clock) and SDA (= SDx pin, serial data input and output) signal lines. Both lines are connected to V_{DDIO} externally via pull-up resistors so that they are pulled high when the bus is free.

The I²C interface of the BMX055 is compatible with the I²C Specification UM10204 Rev. 03 (19 June 2007), available at <http://www.nxp.com>. The BMX055 supports I²C standard mode and fast mode, only 7-bit address mode is supported. For V_{DDIO} = 1.2V to 1.8V the guaranteed voltage output levels are slightly relaxed as described in the Parameter Specification (Table 1).

When in I²C mode, the BMX055 will work effectively as three I²C-Slave devices. The BMX055 is not addressed by a single I²C-Address. Instead, the I²C Master (Application processor) should use a different I²C-Address for each component (Accel, Gyro and Magnet) depending on the needed data.

In addition to that, the I²C-Address of each component (Accel, Gyro and Magnet) can be configured by changing the levels in SDO1, SDO2 and CSB3.

The default I²C address of the accelerometer device is 0011000b (0x18) and of the gyro device is 1101000b (0x68). It is used if the SDO1 (AM and G) pin is pulled to 'GND'. The alternative accel address 0011001b (0x19) and/or the alternative gyro address 1101001b (0x69) is selected by pulling the SDO2 (AM and/or G) pin to 'V_{DDIO}'.

The default I²C address of the magnetic device is 0010000b (0x10). The five MSB are hardwired to "00100". Alternative addresses of the magnetic device can be selected fixing the value of SDO or CSB lines. bit0 can be set to "1" by pulling the SDO1 pin to 'V_{DDIO}'. bit1 can be set to "1" by pulling the CSB3 line pin to 'V_{DDIO}'.

For all I²C address combination of the BMX055, please refer to the following table.

Table 64 I²C address

SDO1	SDO2	CSB3	I ² C-Addr_Accel	I ² C-Addr_Gyro	I ² C-Addr_magnet
GND	GND	GND	0x18	0x68	0x10
GND	GND	Vddio	0x18	0x68	0x12
GND	Vddio	GND	0x18	0x69	0x10
GND	Vddio	Vddio	0x18	0x69	0x12
Vddio	GND	GND	0x19	0x68	0x11
Vddio	GND	Vddio	0x19	0x68	0x13
Vddio	Vddio	GND	0x19	0x69	0x11
Vddio	Vddio	Vddio	0x19	0x69	0x13

The timing specification for I²C of the BMX055 is given in Table 64:

Table 64: I²C timings

Parameter	Symbol	Condition	Min	Max	Units
Clock Frequency	t_{SCL}			400	kHz
SCL Low Period	t_{LOW}		1.3		μs
SCL High Period	t_{HIGH}		0.6		
SDA Setup Time	t_{SUDAT}		0.1		
SDA Hold Time	t_{HDDAT}		0.0		
Setup Time for a repeated Start Condition	t_{SUSTA}		0.6		
Hold Time for a Start Condition	t_{HDSTA}		0.6		
Setup Time for a Stop Condition	t_{SUSTO}		0.6		
Time before a new Transmission can start	t_{BUF}		1.3		
Idle time between write accesses, normal mode, standby mode, low-power mode 2	$t_{IDLE_wacc_nm}$		2		μs
Idle time between write accesses, suspend mode, low-power mode 1	$t_{IDLE_wacc_sum}$		450		μs

shows the definition of the I²C timings given in Table 64:

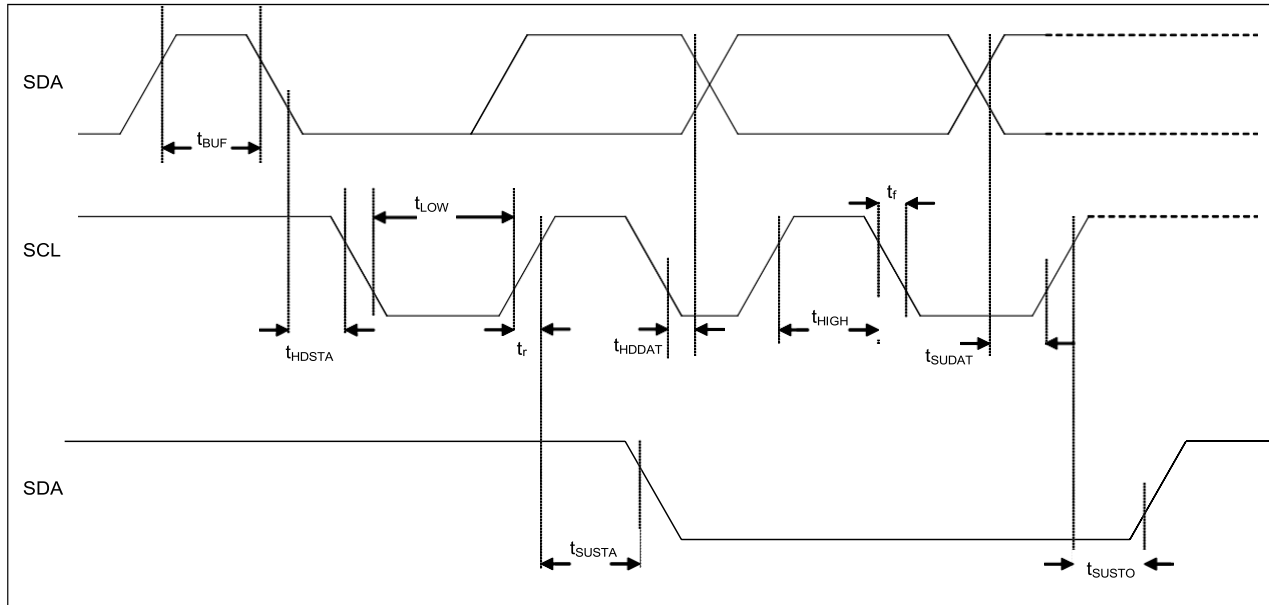

Figure 31: I²C timing diagram

The I²C protocol works as follows:

START: Data transmission on the bus begins with a high to low transition on the SDA line while SCL is held high (start condition (S) indicated by I²C bus master). Once the START signal is transferred by the master, the bus is considered busy.

STOP: Each data transfer should be terminated by a Stop signal (P) generated by master. The STOP condition is a low to HIGH transition on SDA line while SCL is held high.

ACK: Each byte of data transferred must be acknowledged. It is indicated by an acknowledge bit sent by the receiver. The transmitter must release the SDA line (no pull down) during the acknowledge pulse while the receiver must then pull the SDA line low so that it remains stable low during the high period of the acknowledge clock cycle.

In the following diagrams these abbreviations are used:

S	Start
P	Stop
ACKS	Acknowledge by slave
ACKM	Acknowledge by master
NACKM	Not acknowledge by master
RW	Read / Write

A START immediately followed by a STOP (without SCL toggling from 'VDDIO' to 'GND') is not supported. If such a combination occurs, the STOP is not recognized by the device.

I²C write access:

I²C write access can be used to write a data byte in one sequence.

The sequence begins with start condition generated by the master, followed by 7 bits slave address and a write bit (RW = 0). The slave sends an acknowledge bit (ACK = 0) and releases the bus. Then the master sends the one byte register address. The slave again acknowledges the transmission and waits for the 8 bits of data which shall be written to the specified register address. After the slave acknowledges the data byte, the master generates a stop signal and terminates the writing protocol.

Example of an I²C write access to the accelerometer:

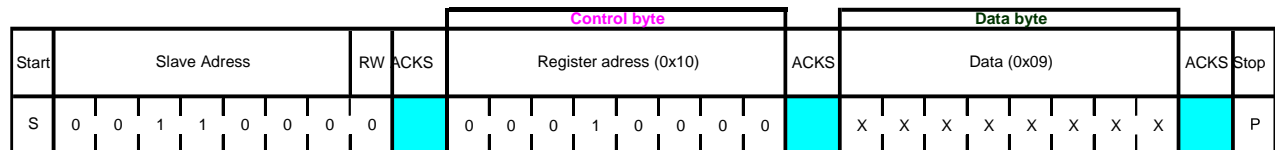

Figure 32: I²C write

I²C read access:

I²C read access also can be used to read one or multiple data bytes in one sequence.

A read sequence consists of a one-byte I²C write phase followed by the I²C read phase. The two parts of the transmission must be separated by a repeated start condition (Sr). The I²C write phase addresses the slave and sends the register address to be read. After slave acknowledges the transmission, the master generates again a start condition and sends the slave address together with a read bit (RW = 1). Then the master releases the bus and waits for the data bytes to be read out from slave. After each data byte the master has to generate an acknowledge bit (ACK = 0) to enable further data transfer. A NACKM (ACK = 1) from the master stops the data being transferred from the slave. The slave releases the bus so that the master can generate a STOP condition and terminate the transmission.

The register address is automatically incremented and, therefore, more than one byte can be sequentially read out. Once a new data read transmission starts, the start address will be set to the register address specified in the latest I²C write command. By default the start address is set at 0x00. In this way repetitive multi-bytes reads from the same starting address are possible.

In order to prevent the I²C slave of the device to lock-up the I²C bus, a watchdog timer (WDT) is implemented. The WDT observes internal I²C signals and resets the I²C interface if the bus is locked-up by the BMX055. The activity and the timer period of the WDT can be configured through the bits (ACC 0x34) plus (GYR 0x34) *i2c_wdt_en* and (ACC 0x34) plus (GYR 0x34) *i2c_wdt_sel*.

Writing '1' ('0') to (ACC 0x34) *i2c_wdt_en* plus (GYR 0x34) *i2c_wdt_en* activates (de-activates) the WDT. Writing '0' ('1') to (ACC 0x34) *i2c_wdt_en* plus (GYR 0x34) *i2c_wdt_sel* selects a timer period of 1 ms (50 ms).

Example of an I²C read access to the accelerometer:

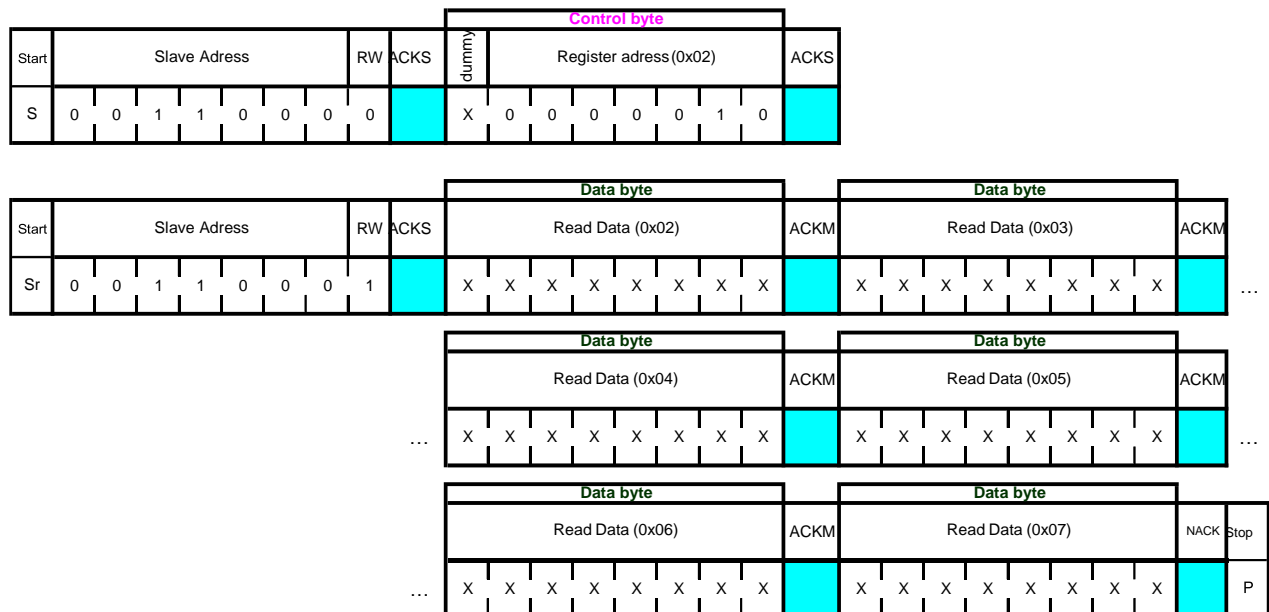

Figure 33: I²C multiple read

11.2.1 SPI and I²C Access Restrictions

In order to allow for the correct internal synchronisation of data written to the BMX055, certain access restrictions apply for consecutive write accesses or a write/read sequence through the SPI as well as I²C interface. The required waiting period depends on whether the device is operating in normal mode or other modes according to chapters 5.1, 7.1, 9.1.

As illustrated in Figure 34, an interface idle time of at least 2 μ s is required following a write operation when the device operates in normal mode. In suspend mode an interface idle time of at least 450 μ s is required.

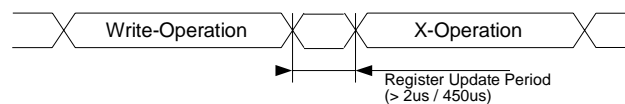

Figure 34: Post-Write Access Timing Constraints

12 FIFO Operation

12.1 FIFO Operating Modes

The BMX055 features 2 integrated FIFO memories capable of storing up to 32 frames of accelerometer data and 100 frames of gyroscope data in FIFO mode. Conceptually each frame consists of three 16 bit words corresponding to the x, y and z- axis of the accelerometer and the gyro, which are sampled at the same point in time. The FIFO is a buffer memory, which can be configured to operate in the following modes:

- FIFO Mode:** In FIFO mode the X, Y and Z acceleration- and rate data of the selected axes and sensors are stored in the buffer memory. If enabled, a watermark interrupt is triggered when the buffer has filled up to a configurable level. The buffer will be continuously filled until the fill level reaches 32 frames for the accelerometer and 100 frames for the gyroscope. When it is full the data collection is stopped, and all additional samples are ignored. Once the buffer is full, a FIFO-full interrupt is generated if it has been enabled.
- STREAM Mode:** In STREAM mode the X, Y and Z acceleration- and rate data of the selected axes are stored in the buffer until it is full. The buffer has a depth of 31 frames of accelerometer data and 99 frames of gyro data. When the buffer is full the data collection continues and oldest entry is discarded. If enabled, a watermark interrupt is triggered when the buffer is filled to a configurable level. Once the buffer is full, a FIFO- full interrupt is generated if it has been enabled.
- BYPASS Mode:** In bypass mode, only the current sensor data can be read out from the FIFO address. Essentially, the FIFO behaves like the STREAM mode with a depth of 1. Compared to reading the data from the normal data registers, the advantage to the user is that the packages X, Y, Z are from the same timestamp, while the data registers are updated sequentially and hence mixing of data from different axes can occur.

The primary FIFO operating mode is selected with register (*ACC 0x3E*) <7:6> and (*GYR 0x0E*) <7:6> according to Table 65. When reading register (*ACC 0x3E*) <7:6> and (*GYR 0x0E*) <7:6> the current operating mode is given. Writing to (*ACC 0x3E*) <7:6> and (*GYR 0x0E*) <7:6> clears and resets the buffer and resets the FIFO-full and watermark interrupt.

Table 65: FIFO operating mode selection

Address: 0x3E bits<7:6> mode<1:0>	FIFO Mode	Function
'00' (Default)	BYPASS	buffer depth of 1 frame; old data are discarded
'01'	FIFO	data collection stops when buffer is full
'10'	STREAM	when buffer full: sampling continues, old data discarded
'11'	Reserved	

12.2 FIFO Data Readout

The FIFO stores the data that are also available at the read-out registers (*ACC 0x02*) to (*ACC 0x07*) for the accelerometer and/or (*GYR 0x02*) to (*GYR 0x07*) for the gyroscope. Thus, all configuration settings apply to the FIFO data as well as the data readout registers. The FIFO read out is possible through register (*ACC 0x3F*) *bits <7:0>* and/or (*GYR 0x3F*) *bits <7:0>*. The readout can be performed using burst mode since the read address counter is no longer incremented, when it has reached address (*0x3F*). This implies that the trapping also occurs when the burst read access starts below address (*0x3F*). A single burst can read out one or more frames at a time. If a frame is not read completely due to an incomplete read operation, the remaining part of the frame is lost. In this case the FIFO aligns to the next frame during the next read operation. The address (*ACC 0x3E*) *bits<1:0>* (*data_select*) or (*GYR 0x3E*) *bits<1:0>* (*data_select*) allows the user to select the data stored in the FIFO according to Table 66. Writing to *data_select<1:0>* clears the FIFO buffer.

Table 66: FIFO data selection

Address: ACC 0x3E and GYR 0x3E bits<1:0> data_select	data of axis stored in FIFO
'00' (Default)	X, Y, Z (plus INT_status0,1 for GYRO)
'01'	X only
'10'	Y only
'11'	Z only
Address: GYR 0x3D bit 7 tag	
'0' (Default)	Do not collect Interrupts for Gyro
'1'	Collect Interrupts for Gyro

12.2.1 Data readout Accelerometer

If all axes and tag are enabled, the format of the data read-out from (*ACC 0x3F*) *fifo_data<7:0>* is as follows:

If all axes are enabled, the format of the data read-out from (*ACC 0x3F*) is as follows:

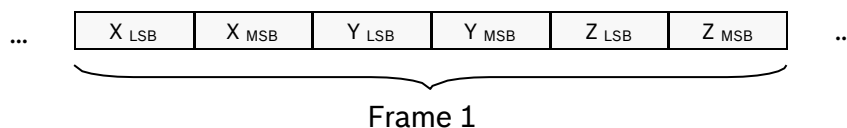

If only one axis is enabled, the format of the data read-out from (*ACC 0x3F*) is as follows (example shown: y-axis only, other axes are equivalent).

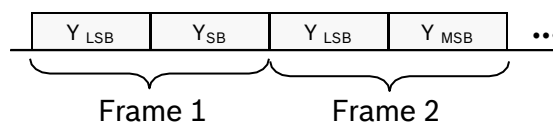

If a frame is not completely read due to an incomplete read operation, the remaining part of the frame is discarded. In this case the FIFO aligns to the next frame during the next read operation. In order for the discarding mechanism to operate correctly, there must be a delay of at least 1.5 μs between the last data bit of the partially read frame and the first address bit of the next FIFO read access. Otherwise frames must not be read out partially.

If the FIFO is read beyond the FIFO fill level zeroes (0) will be read. If the FIFO is read beyond the FIFO fill level the read or burst read access time must not exceed the sampling time t_{SAMPLE} . Otherwise frames may be lost.

12.2.2 Data readout Gyroscope

If all axes and tag are enabled, the format of the data read-out from (GYR 0x3F) fifo_data<7:0> is as follows:

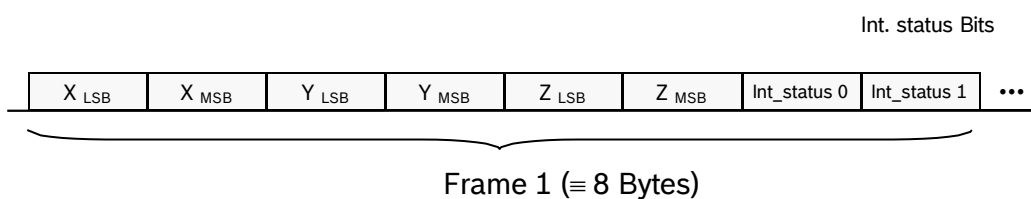

If only one axis is enabled (and tag is disabled), the format of the data read-out from register fifo_data<7:0> is as follows (example shown: Y-axis only, other axis are equivalent). The buffer depth of the FIFO is independent of the fact whether all or a single axis have been selected.

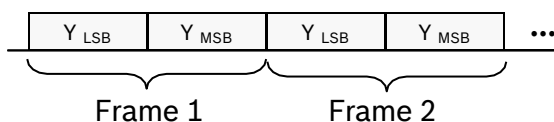

12.2.3 External FIFO synchronization (EFS) for the gyroscope

In addition to the explained data format for the angular rate and interrupt data, the FIFO of the gyroscope features a mode that allows the precise synchronization of external event with the gyroscope angular rate and gyroscope interrupts saved in the internal FIFO. This synchronization can be used for example for image and video stabilization applications. The EFS Mode can be used in the operating modes FIFO-Mode and STREAM-Mode but not in BYPASS-Mode.

In order to use the EFS capability, any of the gyroscope interrupt pins (INT3 or INT4) can be reconfigured to act as EFS-pin, but not both. In addition, the EFS-Mode has to be enabled. The so configured interrupt pin will then behave as an input pin and not as an interrupt pin. The working principle is shown in below figure:

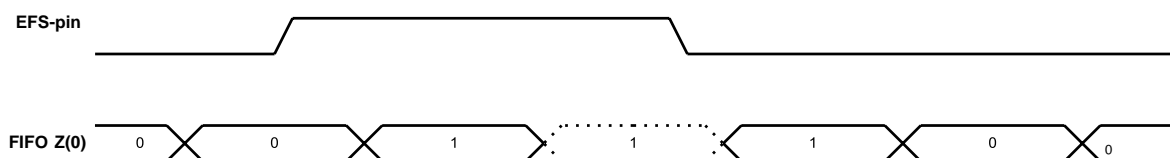

Figure 35: Timing diagram for external FIFO synchronization.

The EFS-pin depicted in Figure 35 is the Interrupt pin configured as EFS-Mode. FIFO z(0) is the least significant bit of the z-axis gyro data stored in the FIFO.

In order to enable the EFS-Mode the register (*GYR 0x34*) bit<5> must be set to “1”. To select the INT4 pin as EFS-pin, set the register (*GYR 0x34*) bit<4> to “1”. To select the INT3 pin as EFS-pin, set the register (*GYR 0x34*) bit<4> to “0”.

In this Mode, the least significant bit of the z-axis is used as tag-bit, therefore losing its meaning as gyroscope data bit. The remaining 15 bits of the z-axis gyroscope data keep the same meaning as in standard mode.

Once the EFS-pin is set to high level, the next FIFO word will be marked with an EFS-tag (z-axis LSB = 1). While the EFS-pin is kept at a High level, the corresponding FIFO words would be always marked with an EFS-tag. After the EFS-pin is reset to low level, the immediate next FIFO word could still be marked with the EFS-tag and only after this word, the next EFS-tag will be reset (z-axis LSB=0). This is shown in the above diagram.

The EFS-tag synchronizes external events with the same time precision as the FIFO update rate. Therefore update rate of the EFS-tag is determined by the output data rate and can be set from 100Hz up to 2,000Hz. For more information consult the register (*GYR 0x10*) (BW) in the register description.

12.2.3.1 Interface speed requirements for Gyroscope FIFO use

In order to use the FIFO effectively, larger blocks of data need to be read out quickly. Depending on the output data rate of the sensor, this can impose requirements on the interface.

The output data rate of the gyroscope is determined by the filter configuration (see chapter 8.2). What interface speed is required depends on the selected rate.

- For an I²C speed of 400 kHz, every filter mode can be used.
- For an I²C speed of 200 kHz, only modes with an output data rate of 1 KHz and below are recommended.
- For an I²C speed of 100 kHz, only modes with an output data rate of 400 Hz and below are recommended.

12.3 FIFO Frame Counter and Overrun Flag

The address ACC and GYR 0x0E bits<6:0> (frame_counter<6:0>) indicate the current fill level of the buffer. If additional frames are written to the buffer although the FIFO is full, the address ACC and GYR 0x0E bit 7 (overrun flag) is set. If the FIFO is reset, the FIFO fill level indicated in the frame_counter<6:0> is set to ‘0’ and the overrun flag is reset each time a write operation happens to the FIFO configuration registers. The overrun bit is not reset when the FIFO fill level frame_counter<6:0> has decremented to ‘0’ due to reading from the fifo_data<7:0> register.

12.4 FIFO Interrupts

The FIFO controller has the capability to issue two different interrupt events, the FIFO-full and the watermark event. Generally the FIFO-full and watermark interrupts are functional in all non-composite modes, including BYPASS.

In order to enable (disable) the watermark and the FIFO-full- interrupt for the accelerometer the (ACC 0x17) int_fwm_en bit, the int_full_en bit, as well as one or both of the int1_fwm or

Int2_fwm and int1_full or Int2_full and bits must be set to '1' ('0'). For the gyroscope, the fifo_wm_en bit, the fifo_en bit, as well as one or both of the int1_fifo or int2_fifo bits must be set. Details are given in Table 67 and Table 68.

The **watermark interrupt** is asserted when the fill level in the buffer has reached the frame number defined by the water mark level trigger (ACC 0x30) and/or (GYR 0x3D). The status of the watermark interrupt for the accelerometer may be read back through the address (ACC 0x0A) bit 6 (fifo_wm_int) status bit. For the gyroscope it may be read back through the address (GYR 0x0A) bit 4 (fifo_int) status bit. Writing to water mark level trigger (ACC 0x30) and/or (GYR 0x3D) register clears the FIFO buffer.

The **FIFO-full interrupt** is the second interrupt capability associated with the FIFO. The FIFO-full interrupt is asserted when the buffer has been fully filled with samples. In FIFO mode this occurs:

- for the accelerometer 32 samples, in STREAM mode 31 samples, and in BYPASS mode 1 sample after the buffer has been cleared.
- for the gyroscope 100 samples, in STREAM mode 99 samples, and in BYPASS mode 1 sample after the buffer has been cleared.

The status of the FIFO-full interrupt for the accelerometer may be read back through the address (ACC 0x0A) bit (fifo_full_int) status bit. For the gyroscope it may be read back through the address (GYR 0x0A) bit 4 (fifo_int) status bit.

Table 67: Interrupt configuration bits relevant for the accelerometer FIFO controller

ACC Register	ACC Address
fifo_water_mark_level_trigger_retain <5:0>	0x30 bits<5:0>
int_fwm_en	0x17 bit 6
int_full_en	0x17 bit 5
int1_fwm	0x1A bit 1
int2_fwm	0x1A bit 6
int1_full	0x1A bit 2
int2_full	0x1A bit 5

Table 68: Interrupt configuration bits relevant for the gyroscope FIFO controller

GYR Register	GYR Address
h2o_mrk_lvl_trig_ret<6:0>	0x3D bits<6:0>
fifo_wm_en	0x1E bit 7
fifo_en	0x15 bit 6
int1_fifo	0x18 bit 2
int2_fifo	0x18 bit 5

13 Pin-out and connection diagram

13.1 Pin-out

The pin-out of the LGA package is shown in Figure 36.

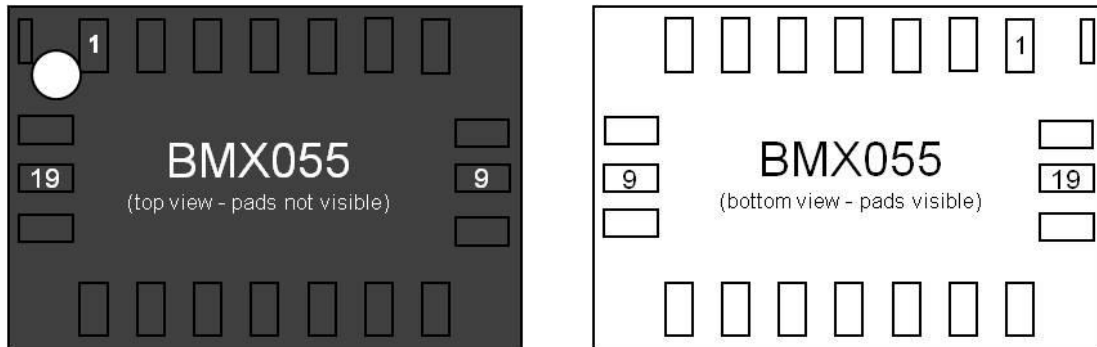

Figure 36: Pin-out top view (left) and

Pin-out bottom view (right)

Table 69: Pin description

Pin#	Name	I/O Type	Description	Connect to		
				in SPI 4W	In SPI 3W	in I ² C
1*	INT2	Digital out	Interrupt pin 2 (accel int #2)	Accelerometer INT input (do not connect if unused)		
2*	DRDYM	Digital out	Data ready (magnet)	Magnet sens. DRDY input (do not connect if unused)		
3	VDD	Supply	Power supply analog & digital domain (2.4 - 3.6V)	V _{DD}	V _{DD}	V _{DD}
4	GNDA	Ground	Ground for analog domain	GND	GND	GND
5	CSB2	Digital in	SPI chip select gyro	CSB2	CSB2	DNC (float) **
6	GNDIO	Ground	Ground for I/O	GND	GND	GND
7	PS	Digital in	Protocol select (GND = SPI, V _{DDIO} = I ² C)	GND	GND	V _{DDIO}
8	NC	-	Not connected	Do not connect		
9	SCx	Digital in	SPI: serial clock SCK I ² C: serial clock SCL	SCK	SCK	SCL
10*	INT5	Digital out	Interrupt pin (magnet)	Magnet INT input (do not connect if unused)		
11	SDx	Digital I/O	I ² C: SDA serial data I/O SPI 4W: SDI serial data I SPI 3W: SDA serial data I/O	SDI	SDA	SDA
12	SDO2	Digital out	SPI serial data out gyro Address select in I ² C mode see chapter 11.2	SDO2	DNC (float)	GND for default addr.
13	VDDIO	Supply	Digital I/O supply voltage (1.2V ... 3.6V)	V _{DDIO}	V _{DDIO}	V _{DDIO}
14*	INT3	Digital I/O	Interrupt pin 3 (gyro int #1)	Gyro INT1 input (do not connect if unused)		
15*	INT4	Digital I/O	Interrupt pin 4 (gyro int #2)	Gyro INT2 input (do not connect if unused)		
16	CSB1	Digital in	SPI chip select accel	CSB1	CSB1	DNC (float) **
17	SDO1	Digital out	SPI serial data out accel / magnet. sensor I ² C-Address[0] of accel / magnet. sensor in I ² C mode see chapter 11.2	SDO1	DNC (float)	GND for default addr.
18	NC	-	Not connected	Do not connect		
19*	INT1	Digital out	Interrupt pin 1 (accel int #1)	Accelerometer INT1 input (do not connect if unused)		
20	CSB3	Digital in	SPI chip select magnet. sensor I ² C-Address[1] of magnet. sensor in I ² C mode see chapter 11.2	CSB3	CSB3	GND for default addr.

* If INT are not used, please do not connect them (DNC)!

** connecting to V_{DDIO} also allowed

13.2 Connection diagram 4-wire SPI

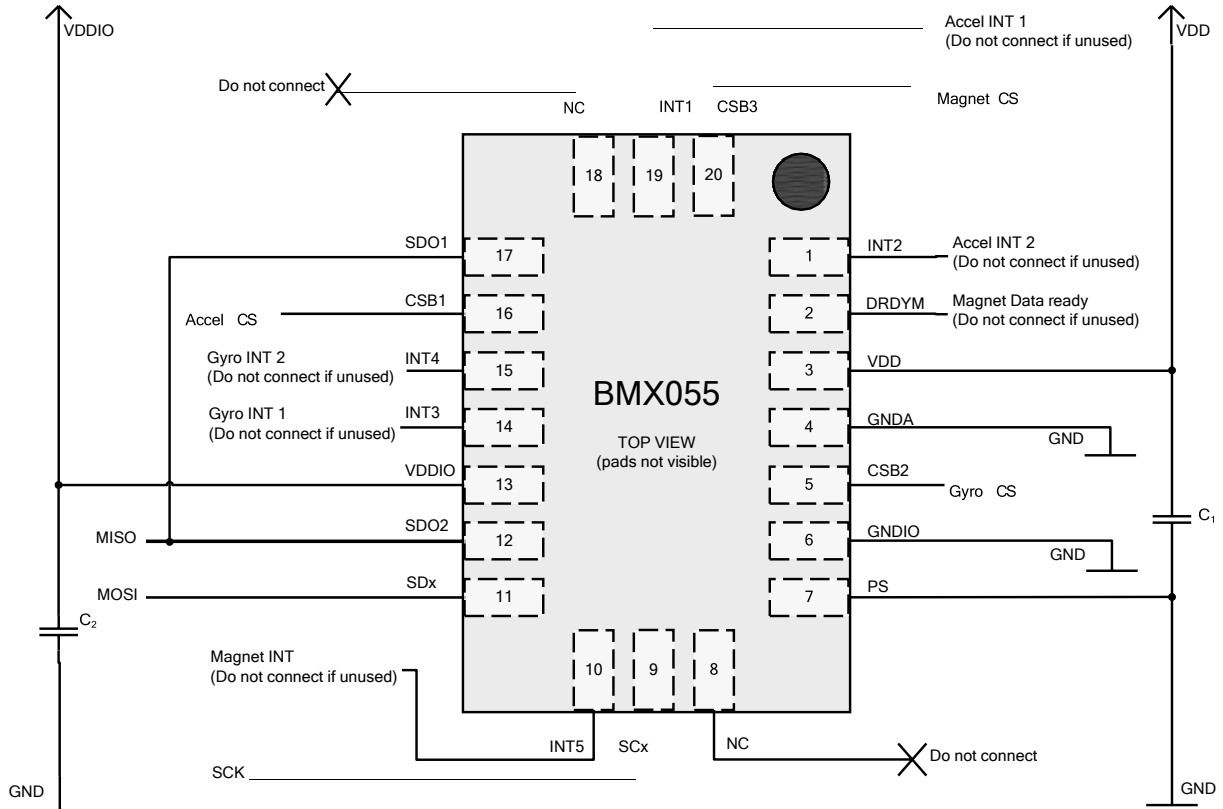

Figure 37: 4-wire SPI connection

13.3 Connection diagram 3-wire SPI

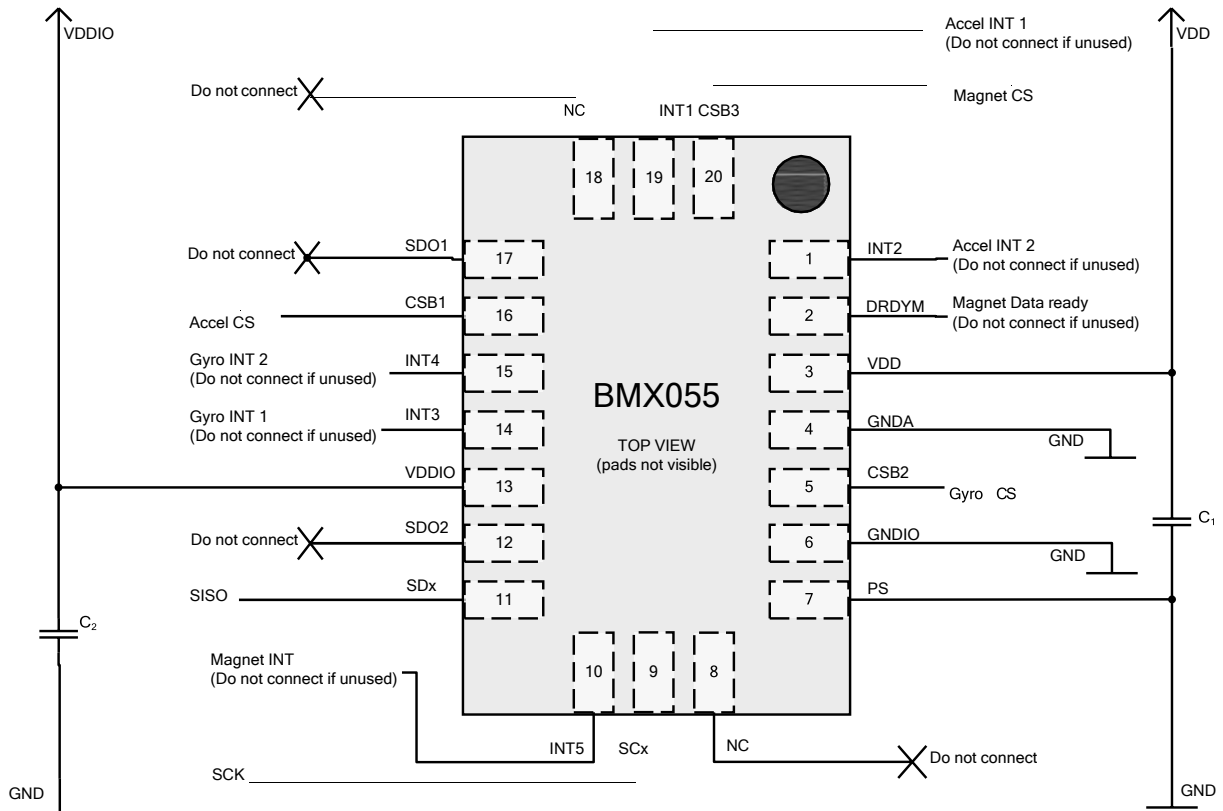

Figure 38: 3-wire SPI connection

13.4 Connection diagram I²C

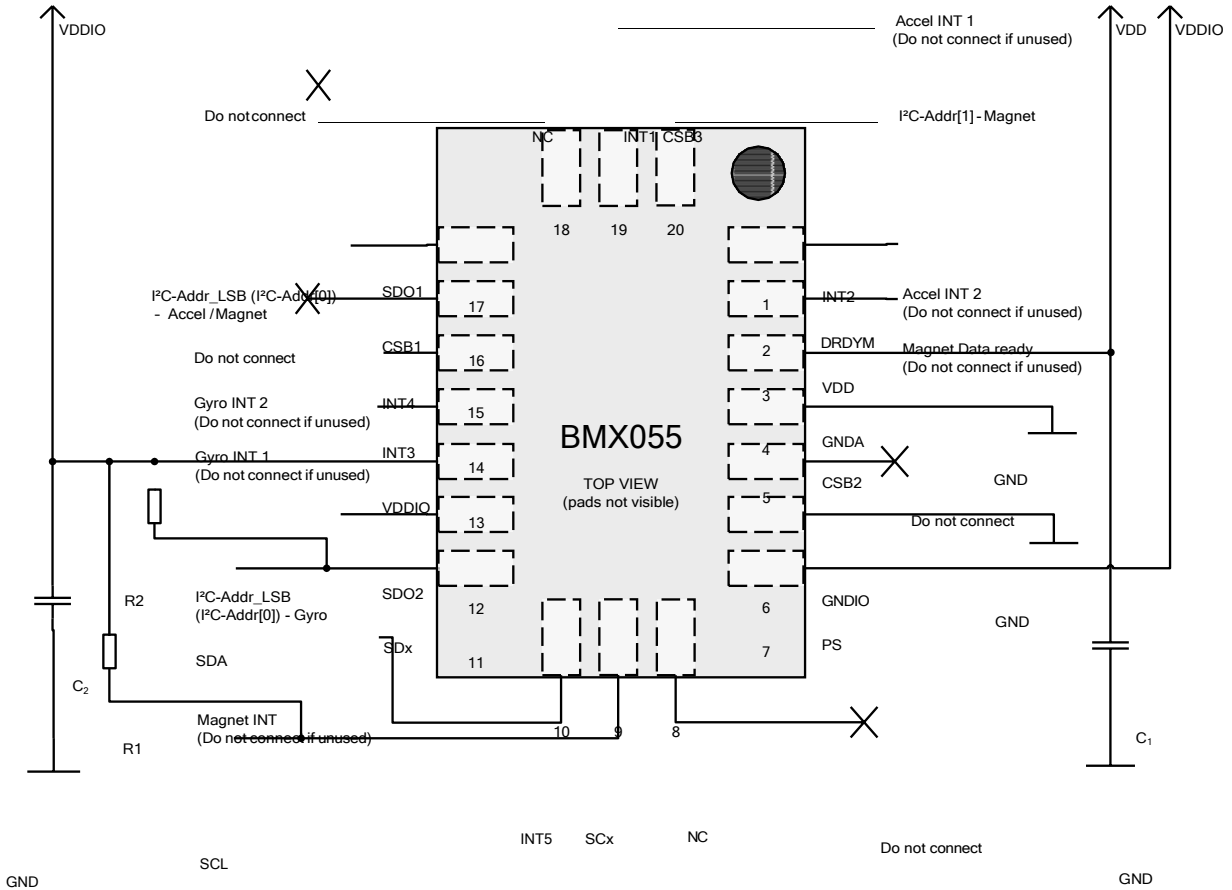

Figure 39: I²C connection

Note: the recommended value for C₁, C₂ is 100 nF.

14 Package

14.1 Outline dimensions

The sensor housing is a standard LGA package. Its dimensions are the following. Unit is mm. Note: Unless otherwise specified tolerance = decimal ± 0.05 mm.

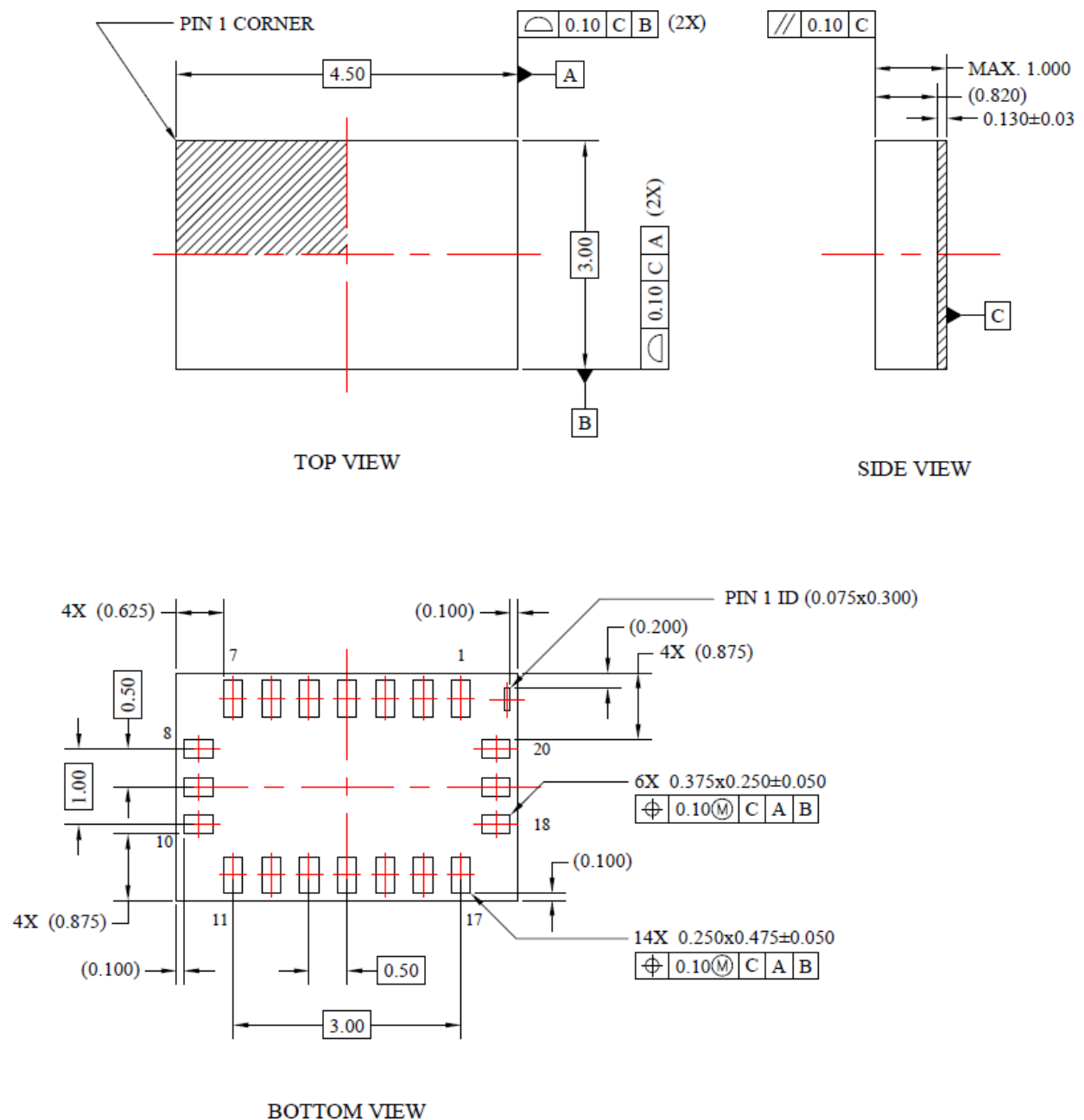

Figure 40: Package outline dimensions in mm

14.2 Sensing axes orientation

If the sensor is accelerated and/or rotated in the indicated directions, the corresponding channels of the device will deliver a positive acceleration and/or yaw rate signal (dynamic acceleration). If the sensor is at rest without any rotation and the force of gravity is acting contrary to the indicated directions, the output of the corresponding acceleration channel will be positive and the corresponding gyroscope channel will be “zero” (static acceleration).

Example: If the sensor is at rest or at uniform motion in a gravity field and a static magnetic field according to the figure given below, the output signals are:

Table 70: Example sensor signal output

	ACC	GYR	MAG
X channel	$\pm 0g$	$\pm 0^\circ/\text{sec}$	$0 \mu\text{T}$
Y channel	$\pm 0g$	$\pm 0^\circ/\text{sec}$	$0 \mu\text{T}$
Z channel	$+ 1g$	$\pm 0^\circ/\text{sec}$	$- B $

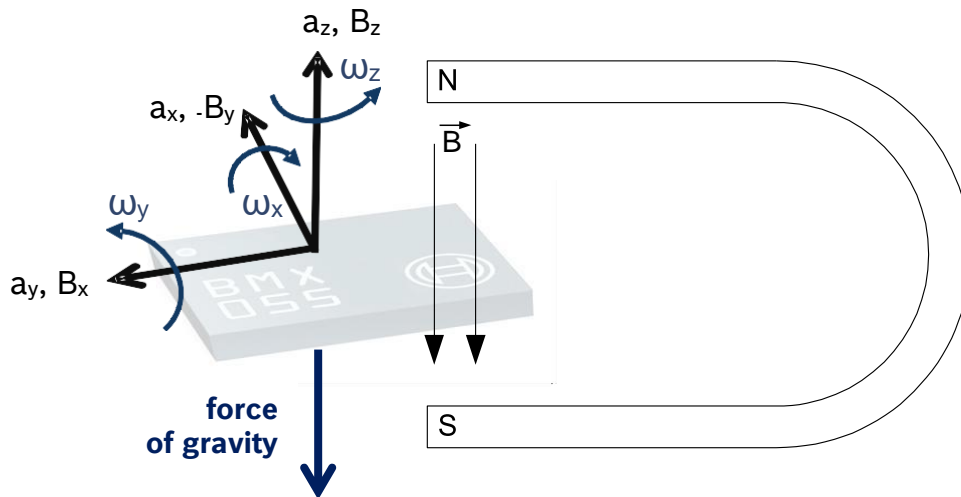
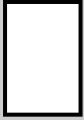
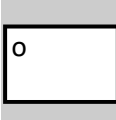



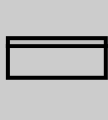

Figure 41: Orientation of sensor sensing axis

The following Table 71 lists all corresponding register output signals on a_x , a_y , a_z and Ω_x , Ω_y , Ω_z and B_x , B_y , B_z while the sensor is at rest or at uniform motion in a gravity field and subjected to a constant vertical magnetic field under assumption of a $\pm 2g$ range setting and a top down gravity vector as shown above.

Table 71: Output signals depending on device orientation

Sensor Orientation (gravity vector \downarrow = static acceleration vector \uparrow , magnetic vector \downarrow)						
Output Signal a_x	0g 0LSB	+1g +1024LSB	0g 0LSB	-1g -1024LSB	0g 0LSB	0g 0LSB
Output Signal a_y	-1g -1024LSB	0g 0LSB	+1g +1024LSB	0g 0LSB	0g 0LSB	0g 0LSB
Output Signal a_z	0g 0LSB	0g 0LSB	0g 0LSB	0g 0LSB	+1g +1024LSB	-1g -1024LSB
Output Signal Ω_x	0°/sec 0LSB	0°/sec 0LSB	0°/sec 0LSB	0°/sec 0LSB	0°/sec 0LSB	0°/sec 0LSB
Output Signal Ω_y	0°/sec 0LSB	0°/sec 0LSB	0°/sec 0LSB	0°/sec 0LSB	0°/sec 0LSB	0°/sec 0LSB
Output Signal Ω_z	0°/sec 0LSB	0°/sec 0LSB	0°/sec 0LSB	0°/sec 0LSB	0°/sec 0LSB	0°/sec 0LSB
Output Signal B_x	+ B μ T	0 μ T	- B μ T	0 μ T	0 μ T	0 μ T
Output Signal B_y	0 μ T	+ B μ T	0 μ T	- B μ T	0 μ T	0 μ T
Output Signal B_z	0 μ T	0 μ T	0 μ T	0 μ T	- B μ T	+ B μ T

14.3 Android axes orientation

The Android coordinate system is shown in Figure 42. The origin is in the lower-left corner with respect to the screen, with the X axis horizontal and pointing right, the Y axis vertical and pointing up and the Z axis pointing outside the front face of the screen. In this system, coordinates behind the screen have negative Z values.

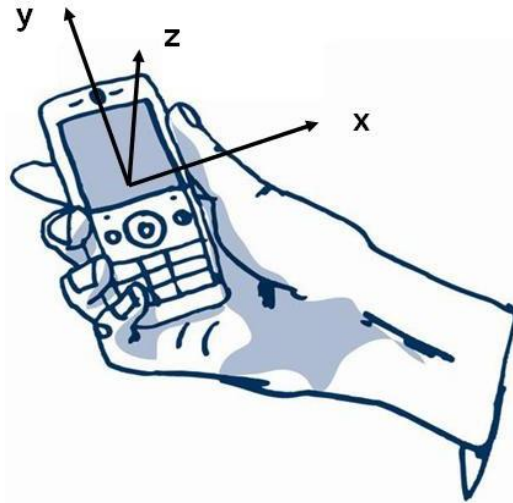

Figure 42: Android coordinate system

Attitude terms are defined in the following way:

- Heading / Azimuth – angle between the magnetic north direction and the Y axis, around the Z axis (0° to 360°). 0° = North, 90° = East, 180° = South, 270° = West.
- Pitch – rotation around X axis (-180° to 180°), with positive values when the z-axis moves toward the y-axis.
- Roll – rotation around Y axis (-90° to 90°), with positive values when the x-axis moves toward the z-axis.

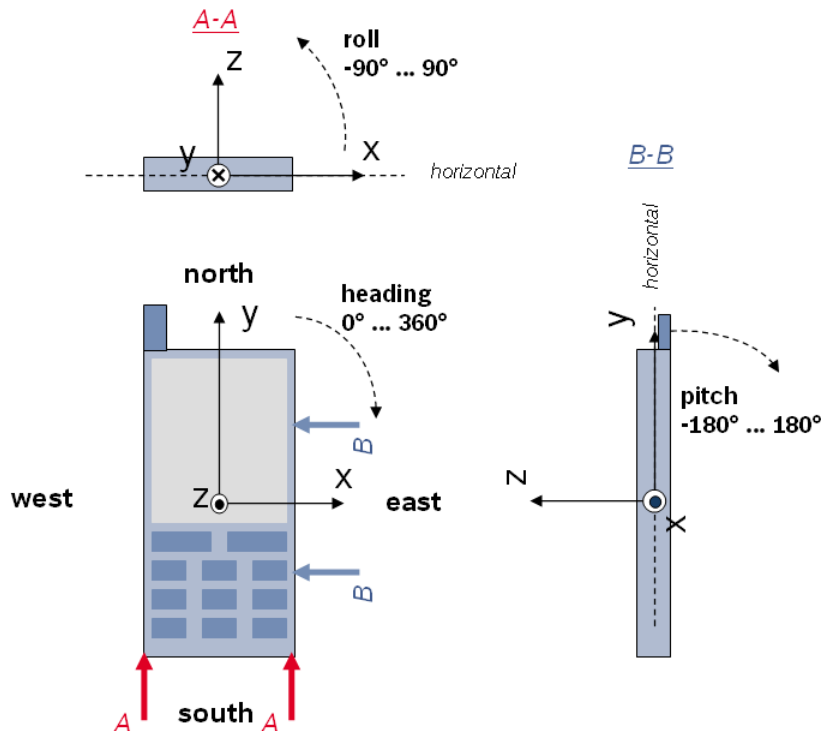

Figure 43: Heading, pitch and roll in Android coordinate frame

14.4 Landing pattern recommendation

For the design of the landing patterns, we recommend the following dimensioning:

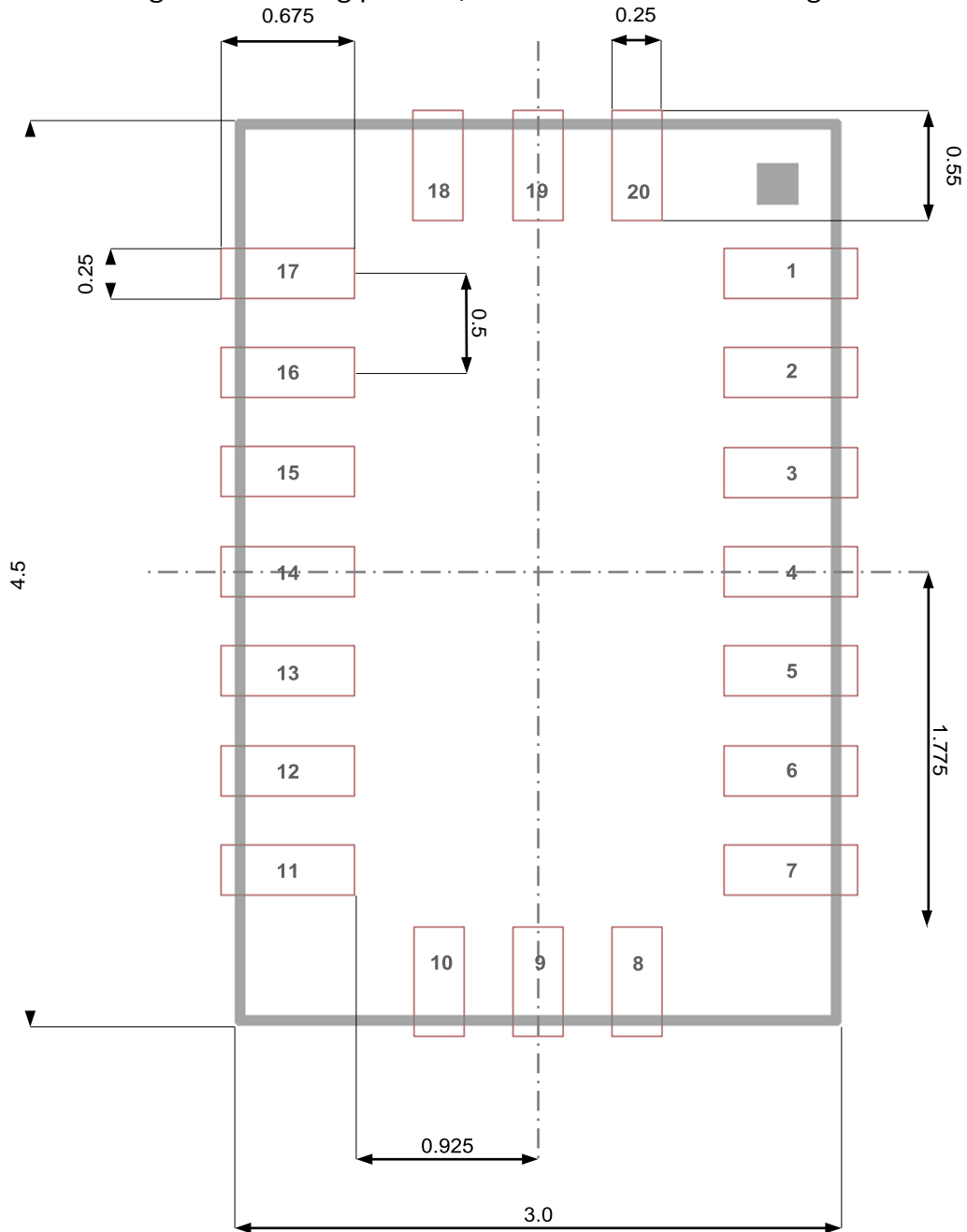

Figure 44: Landing patterns, dimensions are in mm

Same tolerances as given for the outline dimensions (chapter 14.1, Figure 40) should be assumed.

14.5 Marking

14.5.1 Mass production devices

Table 72: Marking of mass production parts

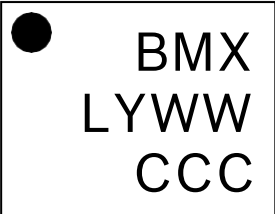
Labeling	Name	Symbol	Remark
	Product number	BMX	3 alphanumeric digits, fixed to identify product type
	Sub-con ID	L	1 alphanumeric digit, variable to identify sub-con (L = "A" or L = "U" or L = "P")
	Date-Code	YWW	3 numeric digits, fixed to identify Y = "year" WW = "working week"
	Lot counter	CCC	3 alphanumeric digits, variable to generate mass production trace-code
	Pin 1 identifier	●	--

14.5.2 Engineering samples

Table 73: Marking of engineering samples

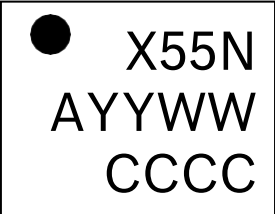
Labeling	Name	Symbol	Remark
	Eng. sample ID	N	1 alphanumeric digit, fixed to identify engineering sample, N = "+" or "e" or "E"
	Sample ID	AYYWW	1 alphanumeric digit (A) for trace-code 2 numeric digit (YY) for date-code 2 numeric digit (WW) for date-code
	Counter ID	CCCC	4 alphanumeric digits, variable to generate trace-code
	Pin 1 identifier	●	--

14.6 Soldering guidelines

The moisture sensitivity level of the BMX055 sensors corresponds to JEDEC Level 1, see also

- IPC/JEDEC J-STD-020C "Joint Industry Standard: Moisture/Reflow Sensitivity Classification for non-hermetic Solid State Surface Mount Devices"
- IPC/JEDEC J-STD-033A "Joint Industry Standard: Handling, Packing, Shipping and Use of Moisture/Reflow Sensitive Surface Mount Devices"

The sensor fulfils the lead-free soldering requirements of the above-mentioned IPC/JEDEC standard, i.e. reflow soldering with a peak temperature up to 260°C.

Profile Feature	Pb-Free Assembly
Average Ramp-Up Rate ($T_{S_{max}}$ to T_p)	3° C/second max.
Preheat - Temperature Min ($T_{S_{min}}$) - Temperature Max ($T_{S_{max}}$) - Time ($t_{s_{min}}$ to $t_{s_{max}}$)	150 °C 200 °C 60-180 seconds
Time maintained above: - Temperature (T_L) - Time (t_L)	217 °C 60-150 seconds
Peak/Classification Temperature (T_p)	260 °C
Time within 5 °C of actual Peak Temperature (t_p)	20-40 seconds
Ramp-Down Rate	6 °C/second max.
Time 25 °C to Peak Temperature	8 minutes max.

Note 1: All temperatures refer to topside of the package, measured on the package body surface.

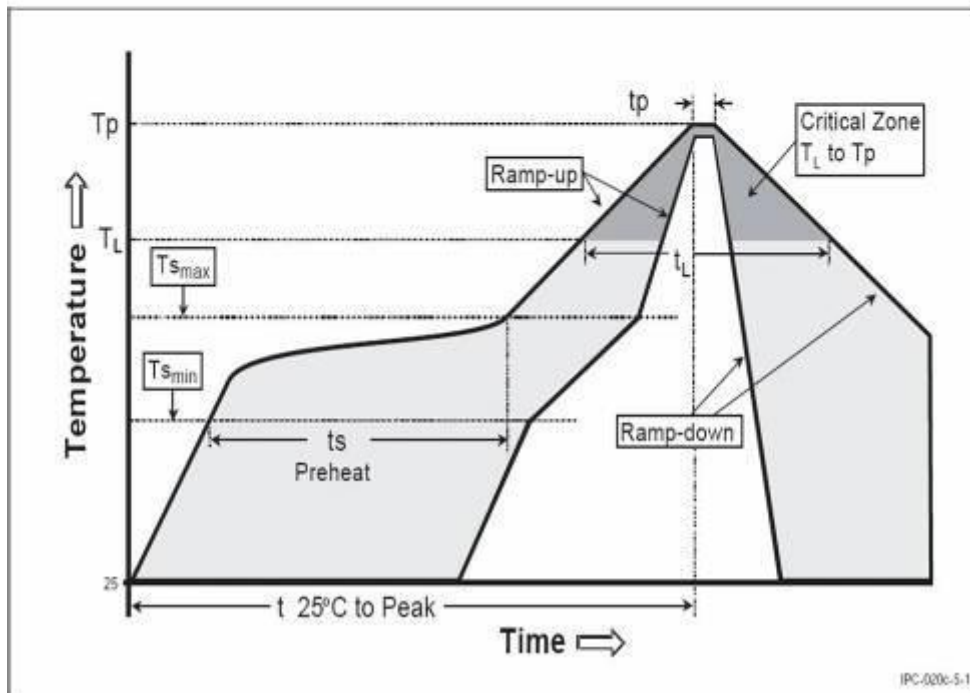

Figure 45: Soldering profile recommendation

14.7 Handling instructions

Micromechanical sensors are designed to sense acceleration with high accuracy even at low amplitudes and contain highly sensitive structures inside the sensor element. The MEMS sensor can tolerate mechanical shocks up to several thousand g's. However, these limits might be exceeded in conditions with extreme shock loads such as e.g. hammer blow on or next to the sensor, dropping of the sensor onto hard surfaces etc.

We recommend to avoid g-forces beyond the specified limits during transport, handling and mounting of the sensors in a defined and qualified installation process.

This device has built-in protections against high electrostatic discharges or electric fields (e.g. 2kV HBM); however, anti-static precautions should be taken as for any other CMOS component. Unless otherwise specified, proper operation can only occur when all terminal voltages are kept within the supply voltage range. Unused inputs must always be tied to a defined logic voltage level.

For more details on recommended handling, soldering and mounting please contact your local Bosch Sensortec sales representative and ask for the "Handling, soldering and mounting instructions" document.

14.8 Tape and reel specification

The BMX055 is shipped in a standard cardboard box.
The box dimension for 1 reel is: L x W x H = 35cm x 35cm x 6cm.
BMX055 quantity: 5,000pcs per reel, please handle with care.

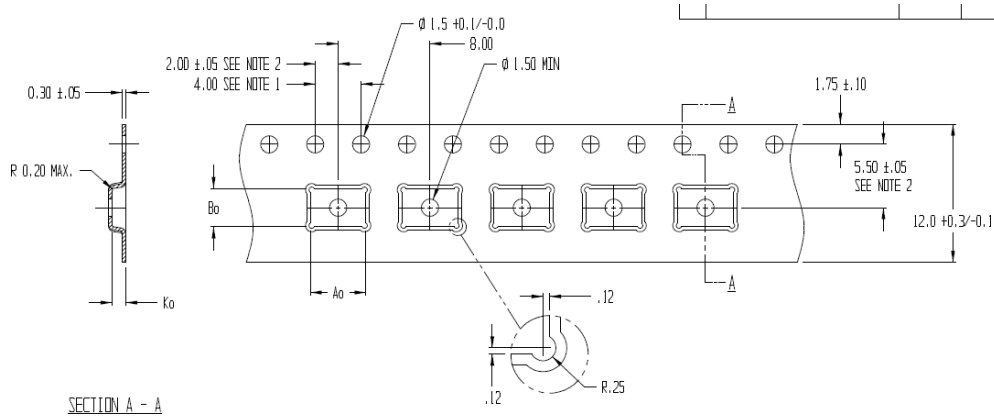

$A_0 = 4.85$
 $B_0 = 3.35$
 $K_0 = 1.20$

Figure 46: Tape and reel dimensions in mm

14.8.1 Orientation within the reel

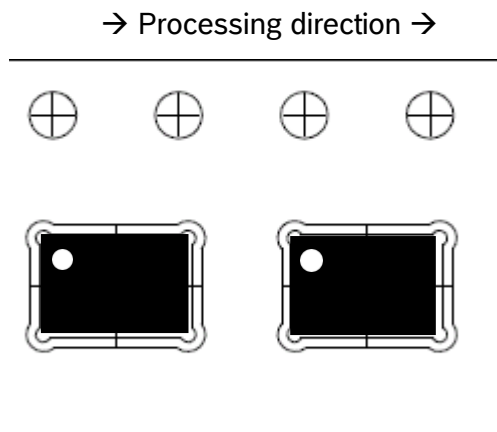

Figure 47: Orientation of the BMX055 devices relative to the tape

14.9 Environmental safety

The BMX055 sensor meets the requirements of the EC restriction of hazardous substances (RoHS and RoHS2) directive, see also:

Directive 2002/95/EC of the European Parliament and of the Council of 27 January 2003 on the restriction of the use of certain hazardous substances in electrical and electronic equipment.

14.9.1 Halogen content

The BMX055 is halogen-free. For more details on the analysis results please contact your Bosch Sensortec representative.

14.9.2 Internal package structure

Within the scope of Bosch Sensortec's ambition to improve its products and secure the mass product supply, Bosch Sensortec qualifies additional sources (e.g. 2nd source) for the LGA package of the BMX055.

While Bosch Sensortec took care that all of the technical packages parameters are described above are 100% identical for all sources, there can be differences in the chemical content and the internal structural between the different package sources.

However, as secured by the extensive product qualification process of Bosch Sensortec, this has no impact to the usage or to the quality of the BMX055 product.

15 Legal disclaimer

15.1 Engineering samples

Engineering Samples are marked with an asterisk (*), (E) or (e). Samples may vary from the valid technical specifications of the product series contained in this data sheet. They are therefore not intended or fit for resale to third parties or for use in end products. Their sole purpose is internal client testing. The testing of an engineering sample may in no way replace the testing of a product series. Bosch Sensortec assumes no liability for the use of engineering samples. The Purchaser shall indemnify Bosch Sensortec from all claims arising from the use of engineering samples.

15.2 Product use

Bosch Sensortec products are developed for the consumer goods industry. They may only be used within the parameters of this product data sheet. They are not fit for use in life-sustaining or safety-critical systems. Safety-critical systems are those for which a malfunction is expected to lead to bodily harm, death or severe property damage. In addition, they shall not be used directly or indirectly for military purposes (including but not limited to nuclear, chemical or biological proliferation of weapons or development of missile technology), nuclear power, deep sea or space applications (including but not limited to satellite technology).

Bosch Sensortec products are released on the basis of the legal and normative requirements relevant to the Bosch Sensortec product for use in the following geographical target market: BE, BG, DK, DE, EE, FI, FR, GR, IE, IT, HR, LV, LT, LU, MT, NL, AT, PL, PT, RO, SE, SK, SI, ES, CZ, HU, CY, US, CN, JP, KR, TW. If you need further information or have further requirements, please contact your local sales contact.

The resale and/or use of Bosch Sensortec products are at the purchaser's own risk and his own responsibility. The examination of fitness for the intended use is the sole responsibility of the purchaser.

The purchaser shall indemnify Bosch Sensortec from all third party claims arising from any product use not covered by the parameters of this product data sheet or not approved by Bosch Sensortec and reimburse Bosch Sensortec for all costs in connection with such claims.

The purchaser accepts the responsibility to monitor the market for the purchased products, particularly with regard to product safety, and to inform Bosch Sensortec without delay of all safety-critical incidents.

15.3 Application examples and hints

With respect to any examples or hints given herein, any typical values stated herein and/or any information regarding the application of the device, Bosch Sensortec hereby disclaims any and all warranties and liabilities of any kind, including without limitation warranties of non-infringement of intellectual property rights or copyrights of any third party. The information given in this document shall in no event be regarded as a guarantee of conditions or characteristics. They are provided for illustrative purposes only and no evaluation regarding infringement of intellectual property rights or copyrights or regarding functionality, performance or error has been made.

16 Document history and modification

Rev. No	Chapter	Description of modification/changes	Date
0.1	-	Initial release	30-March- 2013
1.0	1.2	Table 2 updated	04 October 2013
	1.2	Table 3 updated	
	1.2	Table 4 updated	
	4	Recommendation for power up sequence updated	
	5.1	Description of suspend mode and deep suspend mode updated; equations for LMP2 updated	
	5.2.2	Description of temperature sensor added	
	5.6.3	Recommendation to use pull-up, pull-down resistors added	
	5.6.6.1	Recommendation of single tap usage added	
	5.6.7	<i>orient_hyst</i> description updated	
	5.6.10	Comment added on clearance of interrupt when acceleration is lower than threshold.	
	5.7	Description of accelerometer soft reset updated	
	Acc reg 0x0F	ACC Register 0x0F (PMU_RANGE) description updated	
	Acc reg 0x10	ACC Register 0x10 (PMU_BW) description updated	
	Acc reg 0x12	ACC Register 0x12 (PMU_LOW_POWER) renamed	
	Acc reg 0x14	ACC Register 0x14 (BGW_SOFTRESET) description updated	
	Acc reg 0x2B	ACC Register 0x2B (INT_9) description updated	
	Acc reg 0x30	ACC Register 0x30 (FIFO_CONFIG_0) description updated	
	Acc reg 0x32	ACC Register 0x32 (PMU_SELF_TEST) description updated	
	7.5.2	Description of fast offset compensation updated	
	7.7	Description of gyro interrupts updated	
7.7.3	Recommendation to use pull-up, pull-down resistors added		
12.4	Description of FIFO interrupts updated		
1.1	14.1	Outline dimensions updated	07 Nov 2014
	14.4	Landing pattern recommendation updated	
	14.5.1	Correct chip marking	
1.2	15	Disclaimer Update	27 Nov 2020



Bosch Sensortec GmbH
Gerhard-Kindler-Strasse 8
72770 Reutlingen / Germany

contact@bosch-sensortec.com
www.bosch-sensortec.com

[Modifications reserved](#) | Printed in Germany
Specifications are preliminary and subject to change
without notice
Document number: BST-BMX055-DS000-03
Revision_1.2_112020