

## CSD87588N 同步降压 NexFET™ 电源块 II

### 1 特性

- 半桥电源块
- 电流 20A 时，系统效率达到 90%
- 高达 25A 的工作电流
- 高密度 - 5mm x 2.5mm 接合栅格阵列 (LGA) 封装
- 双侧冷却能力
- 超薄 - 最大厚度为 0.48mm
- 针对 5V 栅极驱动进行了优化
- 低开关损耗
- 低电感封装
- 符合 RoHS 环保标准
- 无卤素
- 无铅

### 2 应用范围

- 同步降压转换器
  - 高电流、低占空比应用
- 多相位同步降压转换器
- 负载点 (POL) 直流 - 直流转换器

### 3 说明

此 CSD87588N NexFET™ 电源块 II 是针对同步降压应用的高度优化设计，能够在 5 mm x 2.5mm 的小外形尺寸封装内提供大电流和高效率。针对 5V 栅极驱动应用进行了优化，这款产品可提供高效且灵活的解决方案，在与外部控制器/驱动器的任一 5V 栅极驱动器成对使用时，均可提供一个供高密度电源。

#### 订购信息<sup>(1)</sup>

器件	介质	数量	封装	出货
CSD87588N	13 英寸卷带	2500	5 x 2.5 LGA	卷带封装
CSD87588NT	7 英寸卷带	250		

(1) 要了解所有可用封装，请见数据表末尾的可订购产品附录。

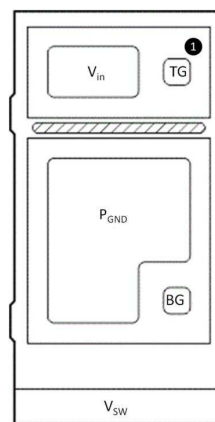

典型电路

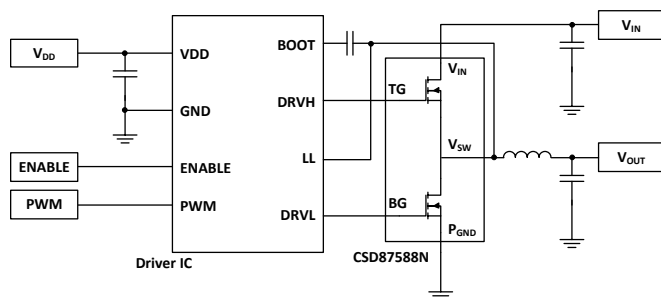

典型电源块效率与功率损耗

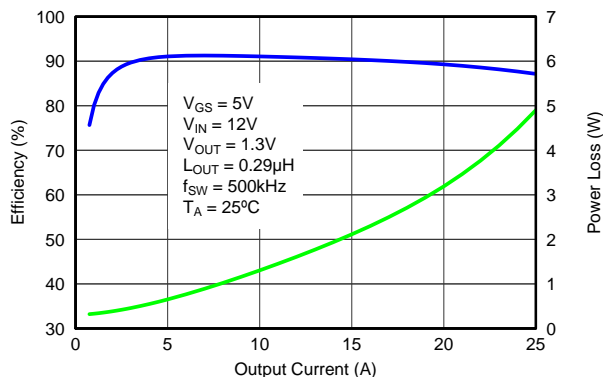

G001



## 目录

<b>1</b>	特性 .....	<b>1</b>	<b>7</b>	<b>Layout</b> .....	<b>13</b>
<b>2</b>	应用范围 .....	<b>1</b>	7.1	Layout Guidelines .....	<b>13</b>
<b>3</b>	说明 .....	<b>1</b>	7.2	Layout Example .....	<b>13</b>
<b>4</b>	修订历史记录 .....	<b>2</b>	<b>8</b>	器件和文档支持 .....	<b>14</b>
<b>5</b>	<b>Specifications</b> .....	<b>3</b>	8.1	商标 .....	<b>14</b>
5.1	Absolute Maximum Ratings .....	<b>3</b>	8.2	静电放电警告 .....	<b>14</b>
5.2	Recommended Operating Conditions .....	<b>3</b>	8.3	术语表 .....	<b>14</b>
5.3	Thermal Information .....	<b>3</b>	<b>9</b>	机械、封装和可订购信息 .....	<b>15</b>
5.4	Power Block Performance .....	<b>4</b>	9.1	CSD87588N 封装尺寸 .....	<b>15</b>
5.5	Electrical Characteristics .....	<b>4</b>	9.2	焊盘布局建议 .....	<b>16</b>
5.6	Typical Power Block Device Characteristics .....	<b>5</b>	9.3	模板建议 (100µm) .....	<b>16</b>
5.7	Typical Power Block MOSFET Characteristics .....	<b>7</b>	9.4	模板建议 (125µm) .....	<b>17</b>
<b>6</b>	<b>Application and Implementation</b> .....	<b>10</b>	9.5	引脚图 .....	<b>17</b>
6.1	Application Information .....	<b>10</b>	9.6	CSD87588N 压纹载带尺寸 .....	<b>18</b>

## 4 修订历史记录

NOTE: Page numbers for previous revisions may differ from page numbers in the current version.

Changes from Revision C (June 2014) to Revision D	Page
• Changed capacitance units to read pF in <a href="#">Figure 15</a> .....	<b>8</b>
• Changed capacitance units to read pF in <a href="#">Figure 16</a> .....	<b>8</b>

Changes from Revision B (January 2014) to Revision C	Page
• 将“无铅引脚镀层”更改成了“无铅” .....	<b>1</b>

Changes from Revision A (May 2013) to Revision B	Page
• 已添加小卷带信息 .....	<b>1</b>
• Updated <a href="#">Figure 5</a> .....	<b>5</b>
• Updated <a href="#">Figure 6</a> .....	<b>5</b>
• Updated <a href="#">Figure 7</a> .....	<b>5</b>
• Updated <a href="#">Figure 8</a> .....	<b>5</b>
• Changed figure reference to <a href="#">Figure 29</a> in electrical performance .....	<b>13</b>

Changes from Original (March 2013) to Revision A	Page
• Changed $R_{\theta JC-PCB}$ To: $R_{\theta JC}$ in the <a href="#">Thermal Information</a> table .....	<b>3</b>

## 5 Specifications

### 5.1 Absolute Maximum Ratings

 $T_A = 25^\circ\text{C}$  (unless otherwise noted) <sup>(1)</sup>

		MIN	MAX	UNIT
Voltage	$V_{IN}$ to $P_{GND}$	-0.8	30	V
	$V_{SW}$ to $P_{GND}$		30	
	$V_{SW}$ to $P_{GND}$ (10 ns)		32	
	$T_G$ to $V_{SW}$	-20	20	
	$B_G$ to $P_{GND}$	-20	20	
$I_{DM}$	Pulsed Current Rating <sup>(2)</sup>		50	A
$P_D$	Power Dissipation <sup>(3)</sup>		6	W
$E_{AS}$	Avalanche Energy	Sync FET, $I_D = 45$ , $L = 0.1$ mH	101	mJ
		Control FET, $I_D = 26$ , $L = 0.1$ mH	34	
$T_J$	Operating Junction	-55	150	$^\circ\text{C}$
$T_{stg}$	Storage Temperature Range	-55	150	$^\circ\text{C}$

- (1) Stresses beyond those listed under *Absolute Maximum Ratings* may cause permanent damage to the device. These are stress ratings only, and functional operation of the device at these or any other conditions beyond those indicated is not implied. Exposure to absolute-maximum-rated conditions for extended periods may affect device reliability.
- (2) Pulse Duration  $\leq 50$   $\mu\text{s}$ , duty cycle  $\leq 0.01$
- (3) Device mounted on FR4 material with 1 inch<sup>2</sup> (6.45 cm<sup>2</sup>) Cu

### 5.2 Recommended Operating Conditions

 $T_A = 25^\circ\text{C}$  (unless otherwise noted)

		MIN	MAX	UNIT	
$V_{GS}$	Gate Drive Voltage	4.5	16	V	
$V_{IN}$	Input Supply Voltage		24	V	
$f_{SW}$	Switching Frequency	$C_{BST} = 0.1$ $\mu\text{F}$ (min)	200	1500	kHz
Operating Current	No Airflow		25	A	
	With Airflow (200 LFM)		30	A	
	With Airflow + Heat Sink		35	A	
$T_J$	Operating Temperature		125	$^\circ\text{C}$	

### 5.3 Thermal Information

 $T_A = 25^\circ\text{C}$  (unless otherwise stated)

THERMAL METRIC		MIN	TYP	MAX	UNIT
$R_{\theta JA}$	Junction-to-ambient thermal resistance (Min Cu) <sup>(1)</sup>			170	$^\circ\text{C/W}$
	Junction-to-ambient thermal resistance (Max Cu) <sup>(2)</sup> <sup>(1)</sup>			70	
$R_{\theta JC}$	Junction-to-case thermal resistance (Top of package) <sup>(1)</sup>			3.7	
	Junction-to-case thermal resistance ( $P_{GND}$ Pin) <sup>(1)</sup>			1.25	

- (1)  $R_{\theta JC}$  is determined with the device mounted on a 1 inch<sup>2</sup> (6.45 cm<sup>2</sup>), 2 oz. (0.071 mm thick) Cu pad on a 1.5 inches  $\times$  1.5 inches (3.81 cm  $\times$  3.81 cm), 0.06 inch (1.52 mm) thick FR4 board.  $R_{\theta JC}$  is specified by design while  $R_{\theta JA}$  is determined by the user's board design.
- (2) Device mounted on FR4 material with 1 inch<sup>2</sup> (6.45 cm<sup>2</sup>) Cu.

## 5.4 Power Block Performance

 $T_A = 25^\circ\text{C}$  (unless otherwise noted)

PARAMETER		CONDITIONS	MIN	TYP	MAX	UNIT
$P_{\text{LOSS}}$	Power Loss <sup>(1)</sup>	$V_{\text{IN}} = 12\text{ V}$ , $V_{\text{GS}} = 5\text{ V}$ $V_{\text{OUT}} = 1.3\text{ V}$ , $I_{\text{OUT}} = 15\text{ A}$ $f_{\text{SW}} = 500\text{ kHz}$ $L_{\text{OUT}} = 0.29\text{ }\mu\text{H}$ , $T_J = 25^\circ\text{C}$		2.1		W
$I_{\text{QVIN}}$	$V_{\text{IN}}$ Quiescent Current	$T_G$ to $T_{\text{GR}} = 0\text{ V}$ $B_G$ to $P_{\text{GND}} = 0\text{ V}$		10		$\mu\text{A}$

(1) Measurement made with six 10  $\mu\text{F}$  (TDK C3216X5R1C106KT or equivalent) ceramic capacitors placed across  $V_{\text{IN}}$  to  $P_{\text{GND}}$  pins and using a high current 5 V driver IC.

## 5.5 Electrical Characteristics

 $T_A = 25^\circ\text{C}$  (unless otherwise stated)

PARAMETER		TEST CONDITIONS	Q1 FET			Q2 FET			UNIT
			MIN	TYP	MAX	MIN	TYP	MAX	
<b>STATIC CHARACTERISTICS</b>									
$BV_{\text{DSS}}$	Drain-to-Source Voltage	$V_{\text{GS}} = 0\text{ V}$ , $I_{\text{DS}} = 250\text{ }\mu\text{A}$	30			30			V
$I_{\text{DSS}}$	Drain-to-Source Leakage Current	$V_{\text{GS}} = 0\text{ V}$ , $V_{\text{DS}} = 24\text{ V}$			1			1	$\mu\text{A}$
$I_{\text{GSS}}$	Gate-to-Source Leakage Current	$V_{\text{DS}} = 0\text{ V}$ , $V_{\text{GS}} = 20$			100			100	nA
$V_{\text{GS(th)}}$	Gate-to-Source Threshold Voltage	$V_{\text{DS}} = V_{\text{GS}}$ , $I_{\text{DS}} = 250\text{ }\mu\text{A}$	1.1		1.9	1.1		1.9	V
$R_{\text{DS(on)}}$	Drain-to-Source On Resistance	$V_{\text{GS}} = 4.5\text{ V}$ , $I_{\text{DS}} = 15\text{ A}$		10.4	12.5		3.5	4.2	m $\Omega$
		$V_{\text{GS}} = 10\text{ V}$ , $I_{\text{DS}} = 15\text{ A}$		8	9.6		2.9	3.5	
$g_{\text{fs}}$	Transconductance	$V_{\text{DS}} = 10\text{ V}$ , $I_{\text{DS}} = 15\text{ A}$		43			93		S
<b>DYNAMIC CHARACTERISTICS</b>									
$C_{\text{ISS}}$	Input Capacitance <sup>(1)</sup>	$V_{\text{GS}} = 0\text{ V}$ , $V_{\text{DS}} = 15\text{ V}$ , $f = 1\text{ MHz}$		566	736		2310	3000	pF
$C_{\text{OSS}}$	Output Capacitance <sup>(1)</sup>			341	444		682	887	pF
$C_{\text{RSS}}$	Reverse Transfer Capacitance <sup>(1)</sup>			10.3	13.4		62	80.4	pF
$R_G$	Series Gate Resistance <sup>(1)</sup>			1.2	2.4		1.1	2.2	$\Omega$
$Q_g$	Gate Charge Total (4.5 V) <sup>(1)</sup>	$V_{\text{DS}} = 15\text{ V}$ , $I_{\text{DS}} = 15\text{ A}$		3.2	4.1		13.7	17.9	nC
$Q_{\text{gd}}$	Gate Charge - Gate-to-Drain			0.7			4.3		nC
$Q_{\text{gs}}$	Gate Charge - Gate-to-Source			1.4			4.3		nC
$Q_{\text{g(th)}}$	Gate Charge at $V_{\text{th}}$			0.8			2.8		nC
$Q_{\text{OSS}}$	Output Charge	$V_{\text{DD}} = 12\text{ V}$ , $V_{\text{GS}} = 0\text{ V}$		7			18.6		nC
$t_{\text{d(on)}}$	Turn On Delay Time	$V_{\text{DS}} = 15\text{ V}$ , $V_{\text{GS}} = 4.5\text{ V}$ , $I_{\text{DS}} = 15\text{ A}$ , $R_G = 2\text{ }\Omega$		7.3			12.1		ns
$t_r$	Rise Time			31.6			36.7		ns
$t_{\text{d(off)}}$	Turn Off Delay Time			10.2			20.1		ns
$t_f$	Fall Time			5.0			6.3		ns
<b>DIODE CHARACTERISTICS</b>									
$V_{\text{SD}}$	Diode Forward Voltage	$I_{\text{DS}} = 15\text{ A}$ , $V_{\text{GS}} = 0\text{ V}$		0.85			0.78		V
$Q_{\text{rr}}$	Reverse Recovery Charge	$V_{\text{dd}} = 15\text{ V}$ , $I_{\text{F}} = 15\text{ A}$ , $di/dt = 300\text{ A}/\mu\text{s}$		12.5			26.7		nC
$t_{\text{rr}}$	Reverse Recovery Time			16			23		ns

(1) Specified by design

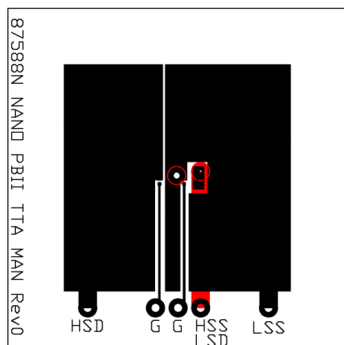

Max  $R_{\theta JA} = 70^{\circ}\text{C/W}$  when mounted on 1 inch<sup>2</sup> (6.45 cm<sup>2</sup>) of 2 oz. (0.071 mm thick) Cu.

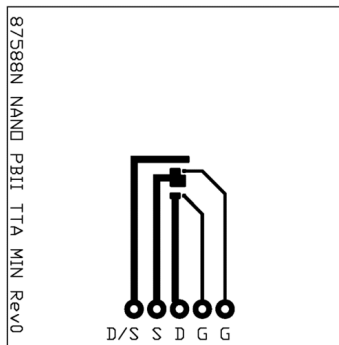

Max  $R_{\theta JA} = 170^{\circ}\text{C/W}$  when mounted on minimum pad area of 2 oz. (0.071 mm thick) Cu.

### 5.6 Typical Power Block Device Characteristics

$T_J = 125^{\circ}\text{C}$ , unless stated otherwise. The Typical Power Block System Characteristic curves [Figure 3](#) and [Figure 4](#) are based on measurements made on a PCB design with dimensions of 4.0 inches (W) × 3.5 inches (L) × 0.062 inch (H) and 6 copper layers of 1 oz. copper thickness. See [Application and Implementation](#) for detailed explanation.

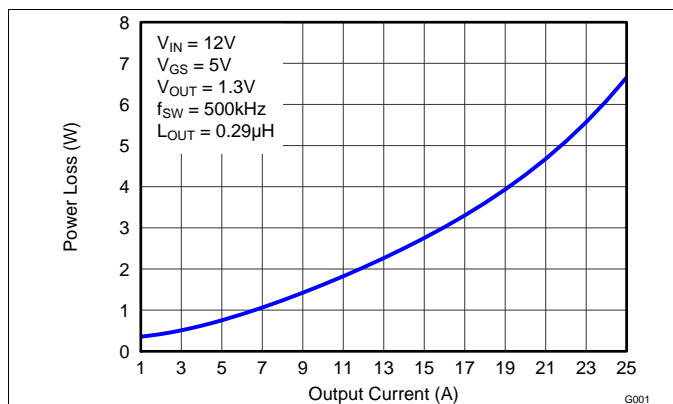

Figure 1. Power Loss vs Output Current

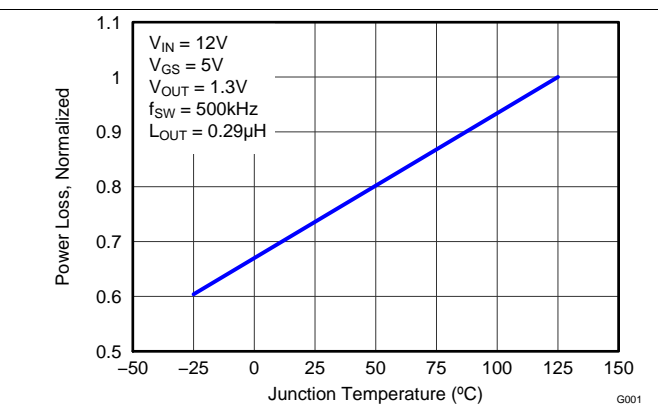

Figure 2. Normalized Power Loss vs Temperature

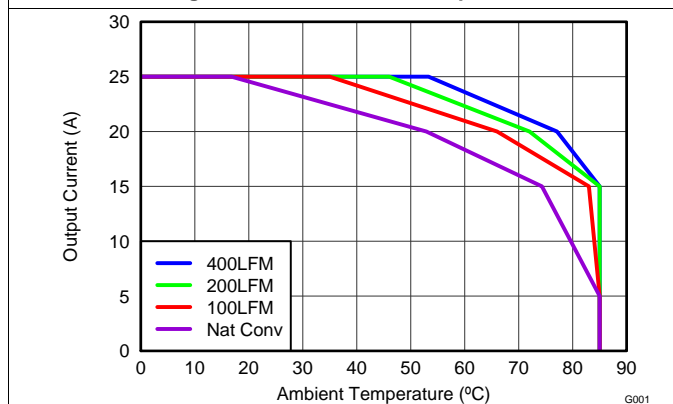

Figure 3. Safe Operating Area – PCB Horizontal Mount

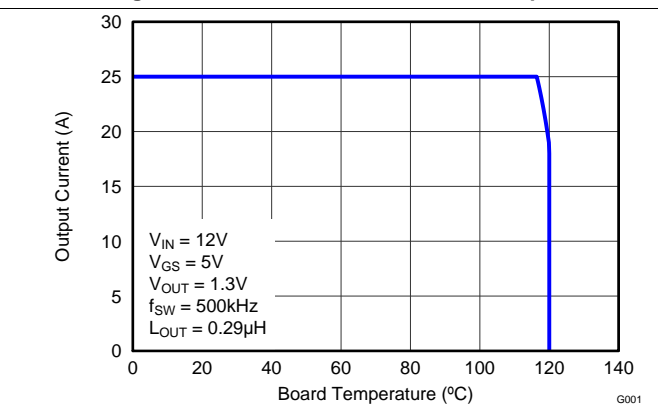

Figure 4. Typical Safe Operating Area

### Typical Power Block Device Characteristics (continued)

$T_J = 125^\circ\text{C}$ , unless stated otherwise. The Typical Power Block System Characteristic curves [Figure 3](#) and [Figure 4](#) are based on measurements made on a PCB design with dimensions of 4.0 inches (W) x 3.5 inches (L) x 0.062 inch (H) and 6 copper layers of 1 oz. copper thickness. See [Application and Implementation](#) for detailed explanation.

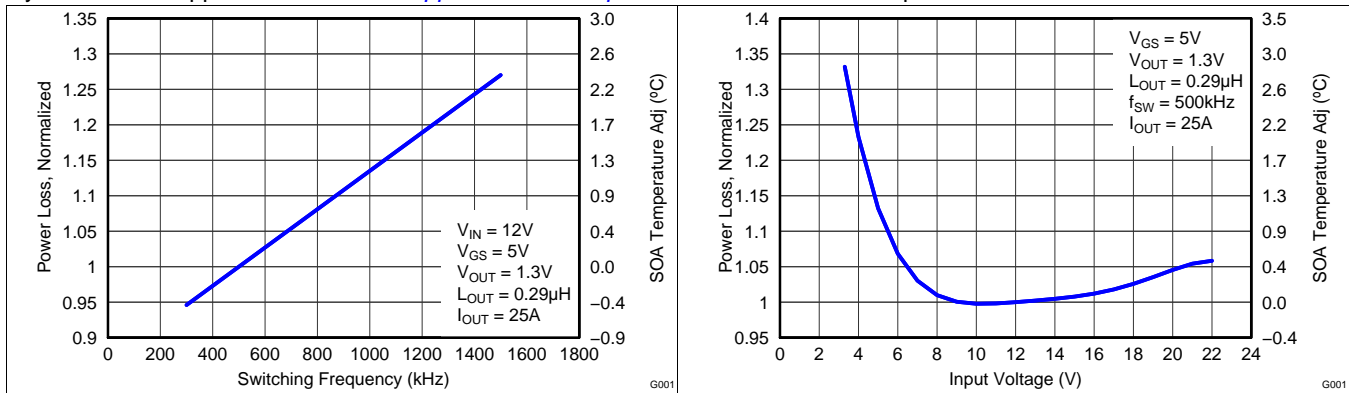

Figure 5. Normalized Power Loss vs Switching Frequency

Figure 6. Normalized Power Loss vs Input Voltage

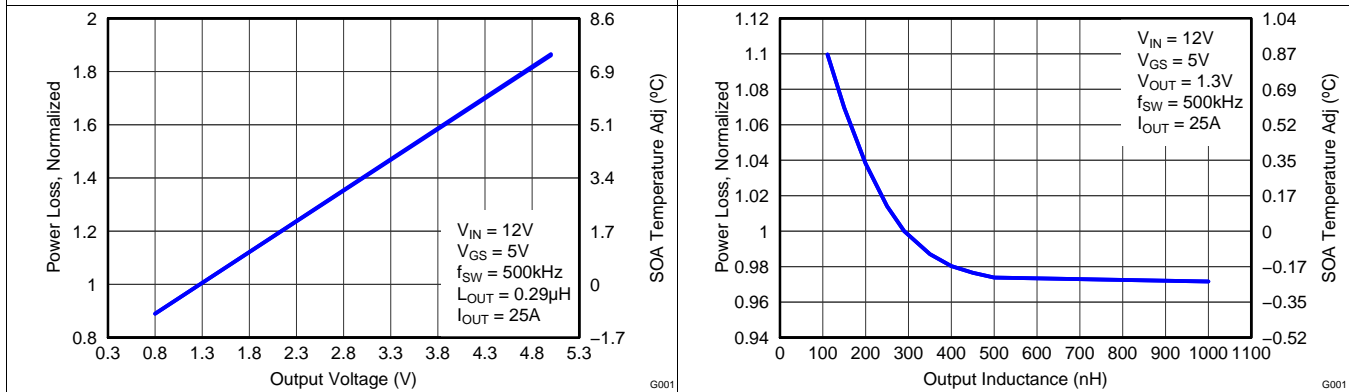
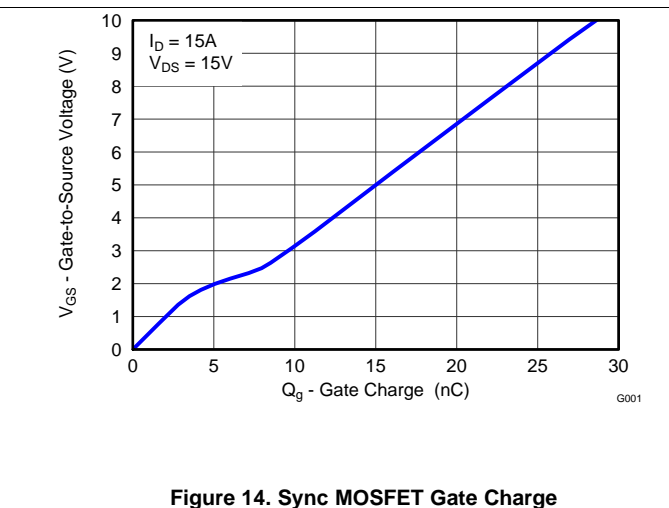
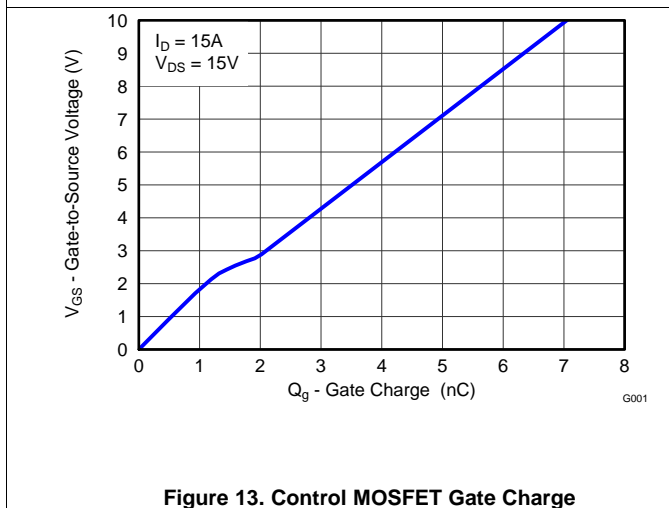
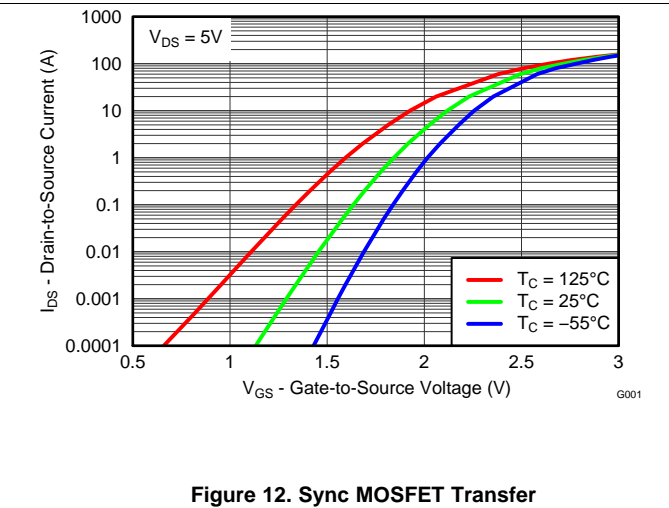
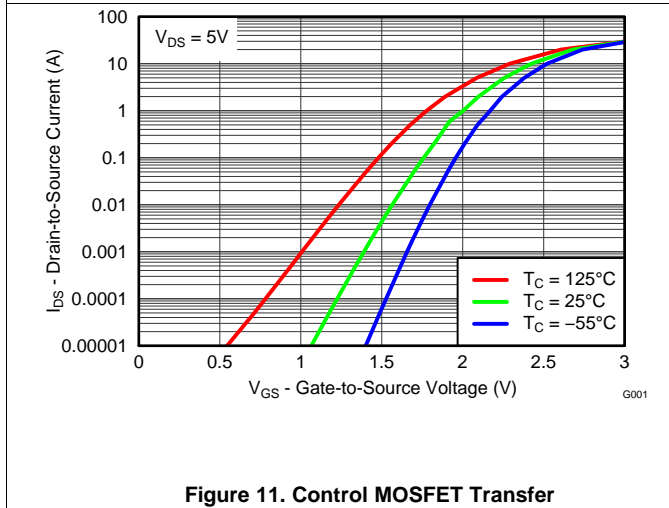
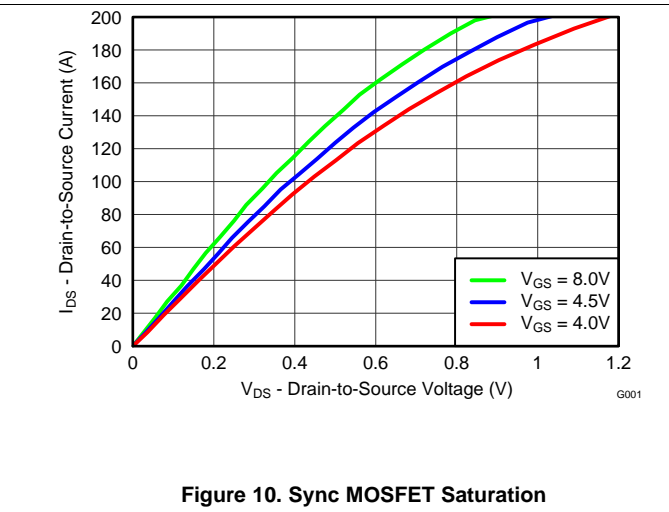
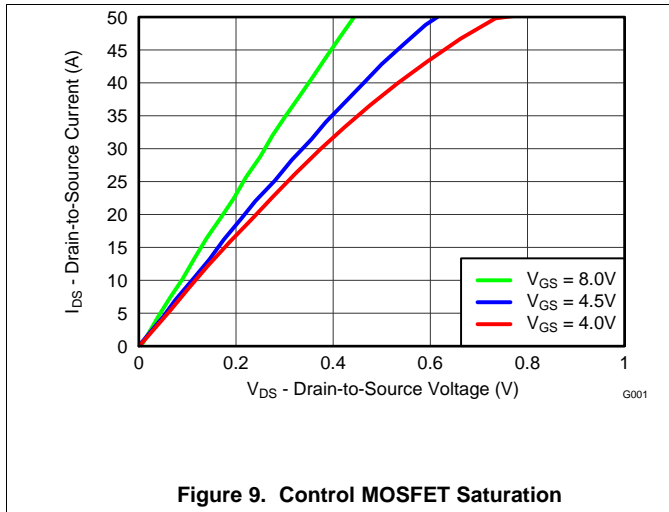

Figure 7. Normalized Power Loss vs Output Voltage

Figure 8. Normalized Power Loss vs Output Inductance

### 5.7 Typical Power Block MOSFET Characteristics

$T_A = 25^\circ\text{C}$ , unless stated otherwise.



Typical Power Block MOSFET Characteristics (continued)

T<sub>A</sub> = 25°C, unless stated otherwise.

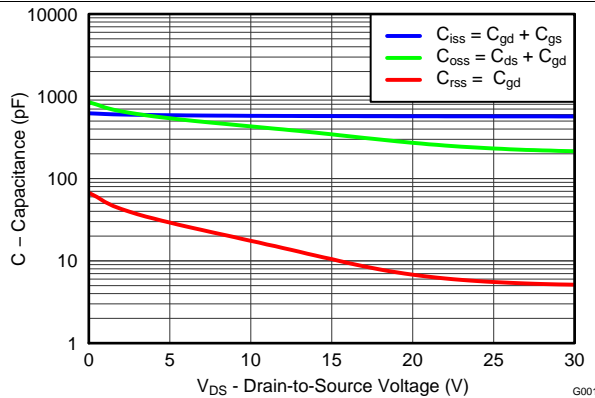

Figure 15. Control MOSFET Capacitance

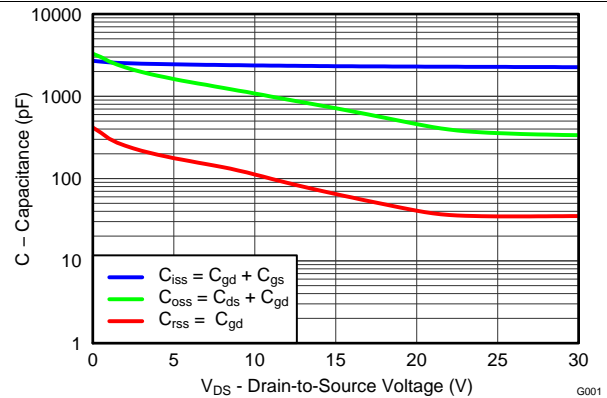

Figure 16. Sync MOSFET Capacitance

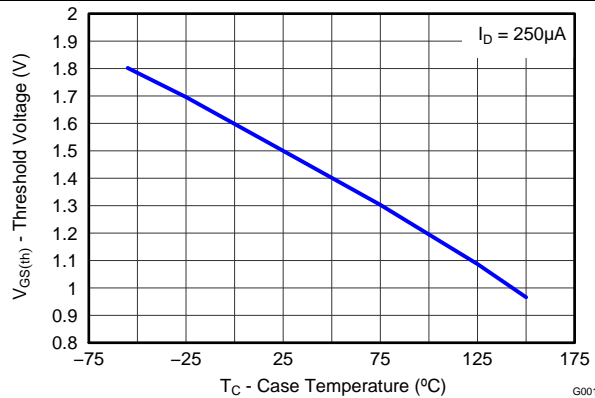

Figure 17. Control MOSFET V<sub>GS(th)</sub>

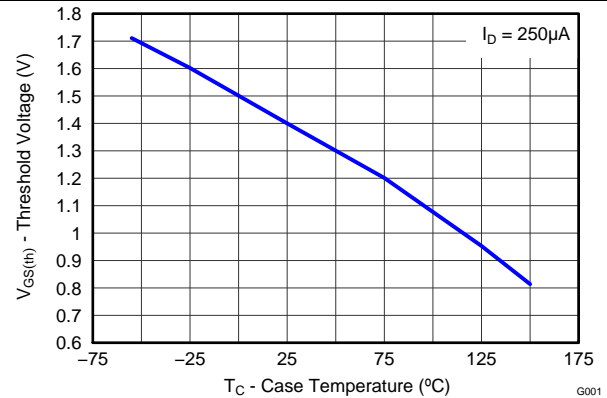

Figure 18. Sync MOSFET V<sub>GS(th)</sub>

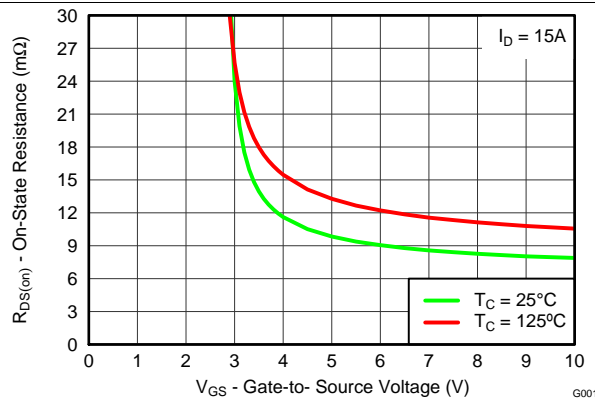

Figure 19. Control MOSFET R<sub>DS(on)</sub> vs V<sub>GS</sub>

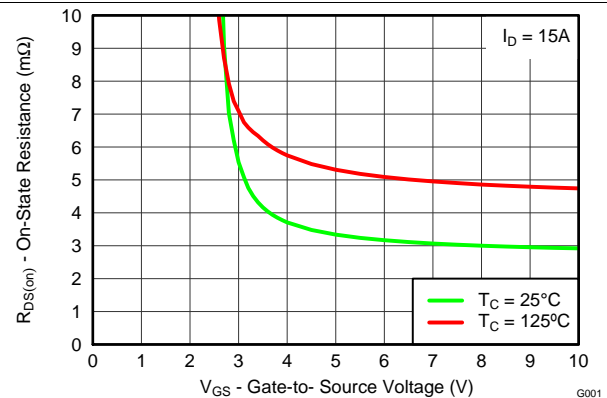

Figure 20. Sync MOSFET R<sub>DS(on)</sub> vs V<sub>GS</sub>



Typical Power Block MOSFET Characteristics (continued)

T<sub>A</sub> = 25°C, unless stated otherwise.

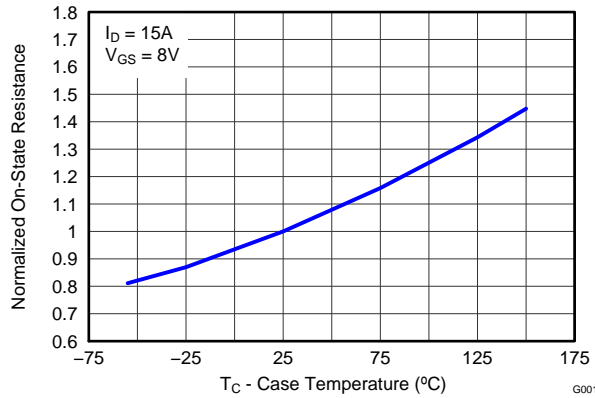

Figure 21. Control MOSFET Normalized R<sub>DS(on)</sub>

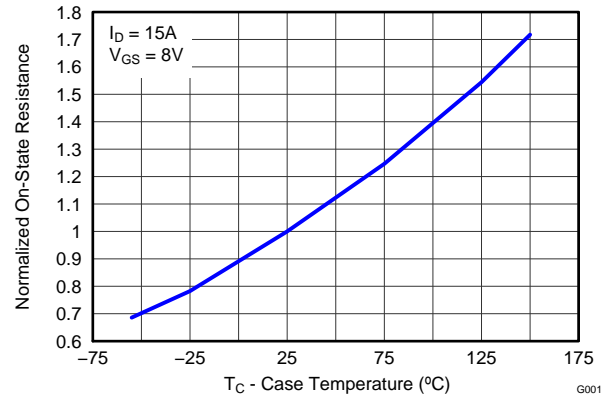

Figure 22. Sync MOSFET Normalized R<sub>DS(on)</sub>

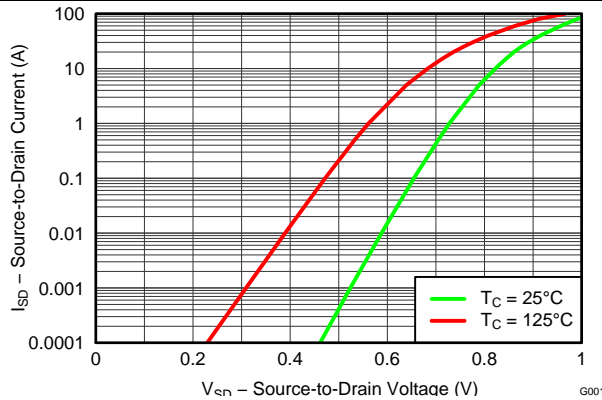

Figure 23. Control MOSFET Body Diode

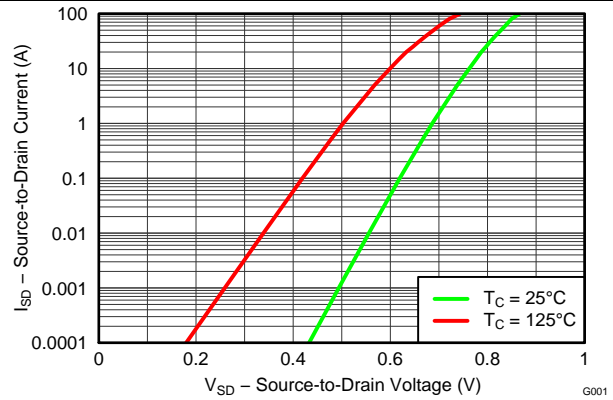

Figure 24. Sync MOSFET Body Diode

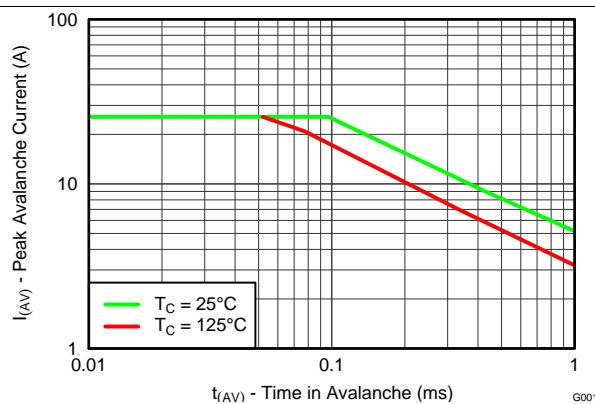

Figure 25. Control MOSFET Unclamped Inductive Switching

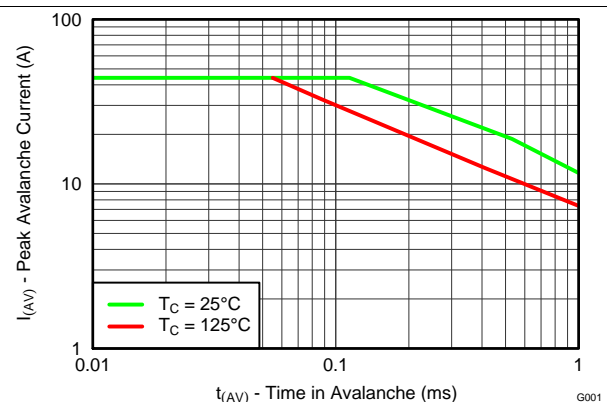

Figure 26. Sync MOSFET Unclamped Inductive Switching

## 6 Application and Implementation

### 6.1 Application Information

The CSD87588N NexFET power block is an optimized design for synchronous buck applications using 5 V gate drive. The Control FET and Sync FET silicon are parametrically tuned to yield the lowest power loss and highest system efficiency. As a result, a new rating method is needed which is tailored toward a more systems-centric environment. System-level performance curves such as Power Loss, Safe Operating Area, and normalized graphs allow engineers to predict the product performance in the actual application.

#### 6.1.1 Power Loss Curves

MOSFET-centric parameters such as  $R_{DS(ON)}$  and  $Q_{gd}$  are needed to estimate the loss generated by the devices. To simplify the design process for engineers, TI has provided measured power loss performance curves. [Figure 1](#) plots the power loss of the CSD87588N as a function of load current. This curve is measured by configuring and running the CSD87588N as it would be in the final application (see [Figure 27](#)). The measured power loss is the CSD87588N loss and consists of both input conversion loss and gate drive loss. [Equation 1](#) is used to generate the power loss curve.

$$(V_{IN} \times I_{IN}) + (V_{DD} \times I_{DD}) - (V_{SW\_AVG} \times I_{OUT}) = \text{Power Loss} \quad (1)$$

The power loss curve in [Figure 1](#) is measured at the maximum recommended junction temperatures of 125°C under isothermal test conditions.

#### 6.1.2 Safe Operating Curves (SOA)

The SOA curves in the CSD87588N data sheet provide guidance on the temperature boundaries within an operating system by incorporating the thermal resistance and system power loss. [Figure 3](#) to [Figure 4](#) outline the temperature and airflow conditions required for a given load current. The area under the curve dictates the safe operating area. All the curves are based on measurements made on a PCB design with dimensions of 4 inches (W) x 3.5 inches (L) x 0.062 inch (T) and 6 copper layers of 1 oz. copper thickness.

#### 6.1.3 Normalized Curves

The normalized curves in the CSD87588N data sheet provides guidance on the Power Loss and SOA adjustments based on their application-specific needs. These curves show how the power loss and SOA boundaries adjust for a given set of systems conditions. The primary y-axis is the normalized change in power loss and the secondary y-axis is the change in system temperature required in order to comply with the SOA curve. The change in power loss is a multiplier for the Power Loss curve and the change in temperature is subtracted from the SOA curve.

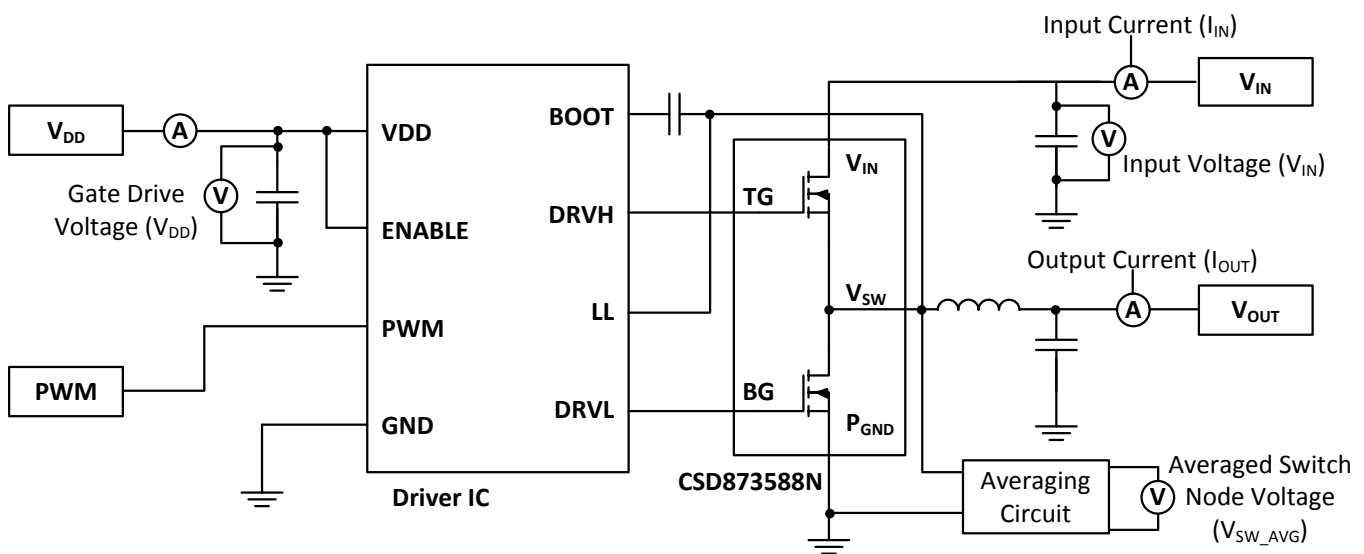

**Figure 27. Typical Application**

## Application Information (continued)

### 6.1.4 Calculating Power Loss and SOA

The user can estimate product loss and SOA boundaries by arithmetic means (see [Design Example](#)). Though the Power Loss and SOA curves in this data sheet are taken for a specific set of test conditions, the following procedure outlines the steps the user should take to predict product performance for any set of system conditions.

#### 6.1.4.1 Design Example

Operating Conditions:

- Output Current = 15 A
- Input Voltage = 7 V
- Output Voltage = 1 V
- Switching Frequency = 800 kHz
- Inductor = 0.2  $\mu$ H

#### 6.1.4.2 Calculating Power Loss

- Power Loss at 15 A = 2.75 W ([Figure 1](#))
- Normalized Power Loss for input voltage  $\approx$  1.03 ([Figure 6](#))
- Normalized Power Loss for output voltage  $\approx$  0.94 ([Figure 7](#))
- Normalized Power Loss for switching frequency  $\approx$  1.08 ([Figure 5](#))
- Normalized Power Loss for output inductor  $\approx$  1.03 ([Figure 8](#))
- **Final calculated Power Loss = 2.75 W  $\times$  1.05  $\times$  0.95  $\times$  1.05  $\times$  1.05  $\approx$  3.02 W**

#### 6.1.4.3 Calculating SOA Adjustments

- SOA adjustment for input voltage  $\approx$  0.3°C ([Figure 6](#))
- SOA adjustment for output voltage  $\approx$  -0.5°C ([Figure 7](#))
- SOA adjustment for switching frequency  $\approx$  0.7°C ([Figure 5](#))
- SOA adjustment for output inductor  $\approx$  0.3°C ([Figure 8](#))
- **Final calculated SOA adjustment = 0.3 + (-0.5) + 0.7 + 0.3  $\approx$  0.8°C**

In the previous design example, the estimated power loss of the CSD87588N would increase to 3.02 W. In addition, the maximum allowable board and/or ambient temperature would have to decrease by 0.8°C. [Figure 28](#) graphically shows how the SOA curve would be adjusted accordingly.

1. Start by drawing a horizontal line from the application current to the SOA curve.
2. Draw a vertical line from the SOA curve intercept down to the board/ambient temperature.
3. Adjust the SOA board/ambient temperature by subtracting the temperature adjustment value.

**Application Information (continued)**

In the design example, the SOA temperature adjustment yields a reduction in allowable board/ambient temperature of 0.8°C. In the event the adjustment value is a negative number, subtracting the negative number would yield an increase in allowable board/ambient temperature.

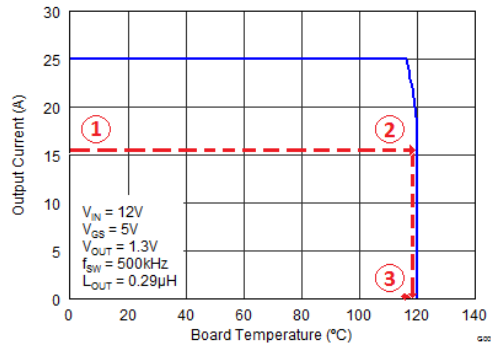

**Figure 28. Power Block SOA**

## 7 Layout

### 7.1 Layout Guidelines

There are two key system-level parameters that can be addressed with a proper PCB design: electrical and thermal performance. Properly optimizing the PCB layout yields maximum performance in both areas. The following sections provide a brief description on how to address each parameter.

#### 7.1.1 Electrical Performance

The CSD87588N has the ability to switch voltages at rates greater than 10 kV/ $\mu$ s. Take special care with the PCB layout design and placement of the input capacitors, inductor, and output capacitors.

- The placement of the input capacitors relative to VIN and PGND pins of CSD87588N device should have the highest priority during the component placement routine. It is critical to minimize these node lengths. As such, ceramic input capacitors need to be placed as close as possible to the VIN and PGND pins (see Figure 29). The example in Figure 29 uses 1 x 10 nF 0402 25 V and 4 x 10  $\mu$ F 1206 25 V ceramic capacitors (TDK part number C3216X5R1C106KT or equivalent). Notice there are ceramic capacitors on both sides of the board with an appropriate amount of vias interconnecting both layers. In terms of priority of placement next to the Power Stage C21, C5, C8, C19, and C18 should follow in order.
- The switching node of the output inductor should be placed relatively close to the Power Block II CSD87588N VSW pins. Minimizing the VSW node length between these two components will reduce the PCB conduction losses and actually reduce the switching noise level. See Figure 29. <sup>(1)</sup>

#### 7.1.2 Thermal Performance

The CSD87588N has the ability to utilize the PGND planes as the primary thermal path. As such, the use of thermal vias is an effective way to pull away heat from the device and into the system board. Concerns of solder voids and manufacturability problems can be addressed by the use of three basic tactics to minimize the amount of solder attach that wicks down the via barrel:

- Intentionally space out the vias from each other to avoid a cluster of holes in a given area.
- Use the smallest drill size allowed in your design. The example in Figure 29 uses vias with a 10 mil drill hole and a 16 mil capture pad.
- Tent the opposite side of the via with solder-mask.

The number and drill size of the thermal vias should align with the end user's PCB design rules and manufacturing capabilities.

### 7.2 Layout Example

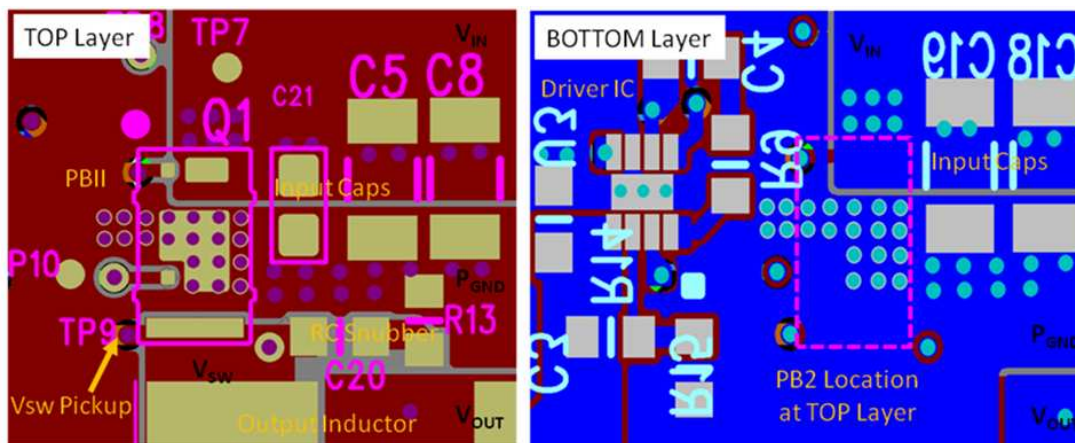

Figure 29. Recommended PCB Layout (Top Down View)

(1) Keong W. Kam, David Pommerenke, "EMI Analysis Methods for Synchronous Buck Converter EMI Root Cause Analysis", University of Missouri – Rolla

## 8 器件和文档支持

### 8.1 商标

NexFET is a trademark of Texas Instruments.  
All other trademarks are the property of their respective owners.

### 8.2 静电放电警告



这些装置包含有限的内置 ESD 保护。存储或装卸时，应将导线一起截短或将装置放置于导电泡棉中，以防止 MOS 门极遭受静电损伤。

### 8.3 术语表

[SLYZ022](#) — *TI* 术语表。

这份术语表列出并解释术语、首字母缩略词和定义。

## 9 机械、封装和可订购信息

以下页中包括机械、封装和可订购信息。 这些信息是针对指定器件可提供的最新数据。 这些数据会在无通知且不对本文档进行修订的情况下发生改变。 欲获得该数据表的浏览器版本，请查阅左侧的导航栏。

### 9.1 CSD87588N 封装尺寸

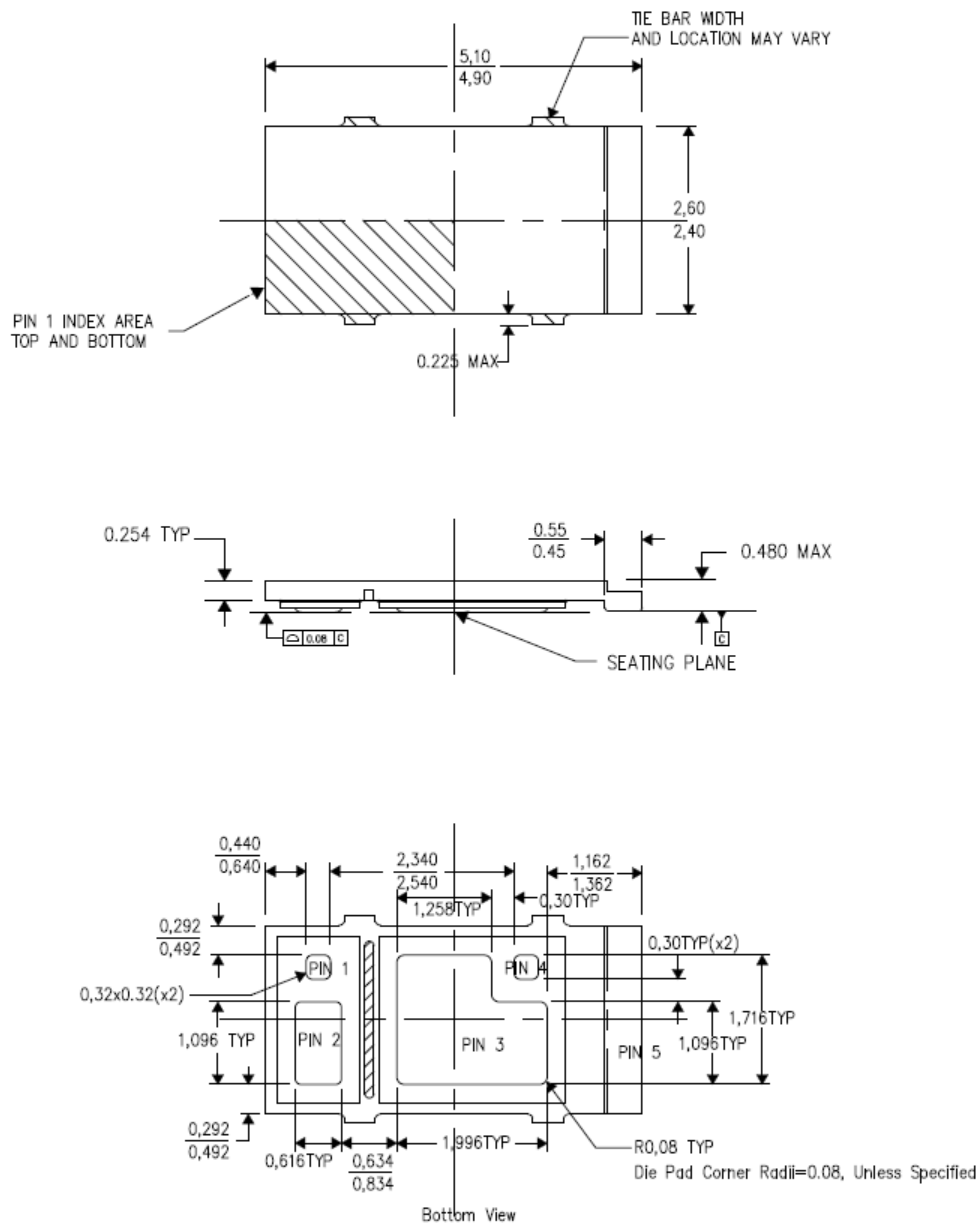

引脚配置

位置	名称
引脚 1	TG
引脚 2	V <sub>IN</sub>
引脚 3	P <sub>GND</sub>
引脚 4	BG
引脚 5	V <sub>SW</sub>

9.2 焊盘布局建议

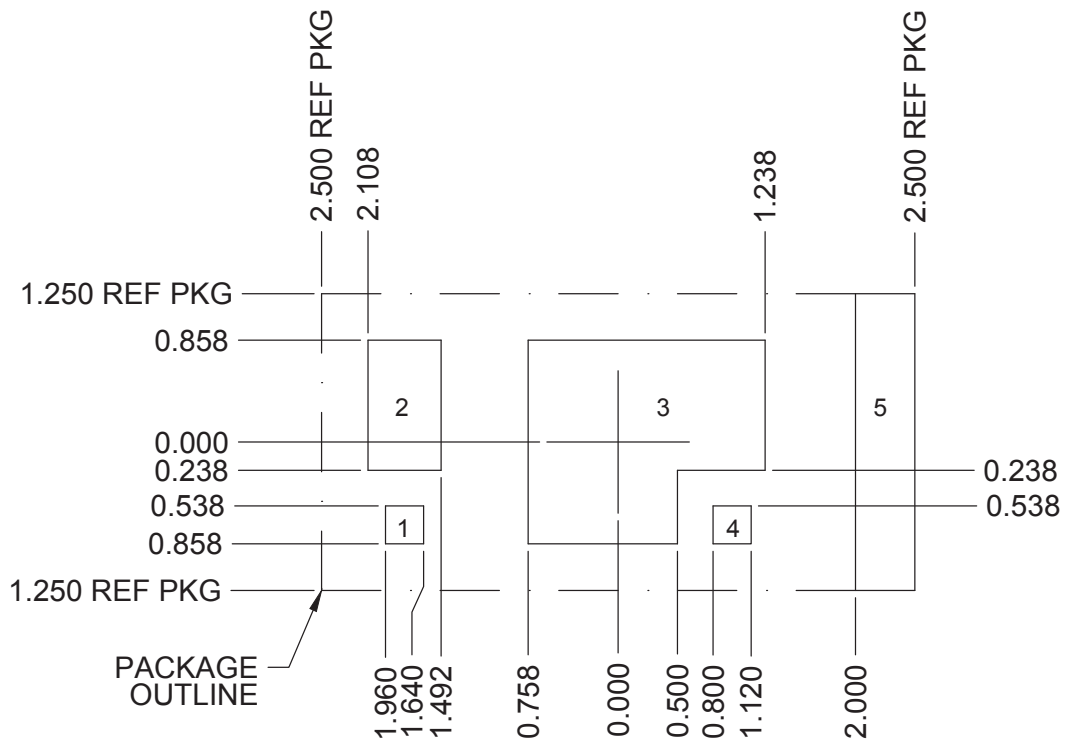

9.3 模板建议 (100μm)

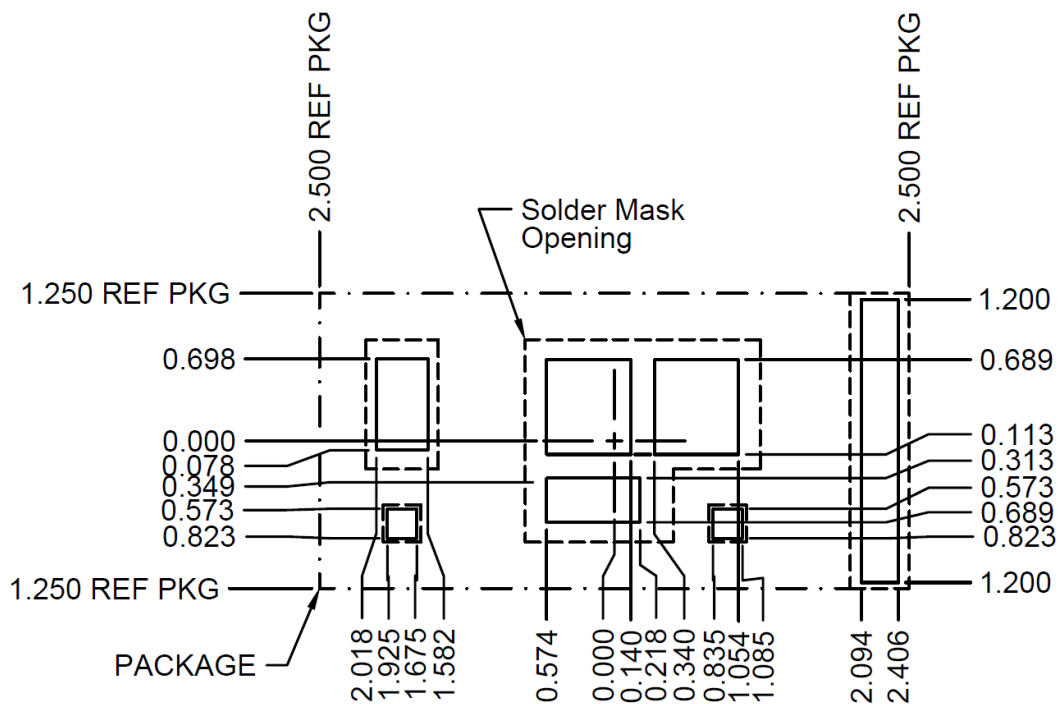



### 9.4 模板建议 (125µm)

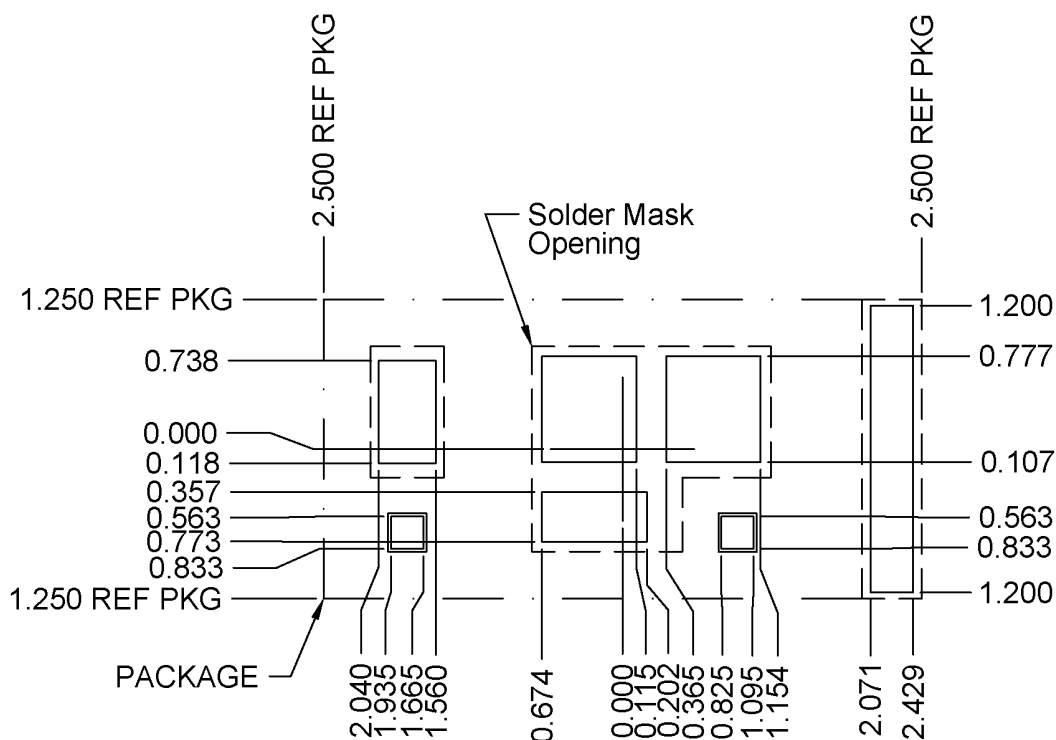

要获得与印刷电路板 (PCB) 设计相关的建议电路布局布线, 请参见《应用说明》[SLPA005 - 通过 PCB 布局布线技巧来减少振铃](#)。

### 9.5 引脚图

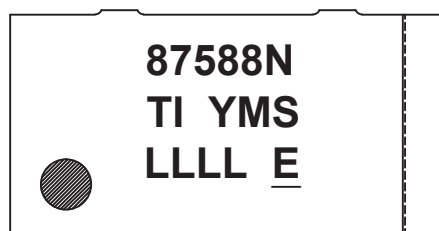

# CSD87588N

ZHCSAY0D – MARCH 2013 – REVISED APRIL 2015

www.ti.com.cn

## 9.6 CSD87588N 压纹载带尺寸

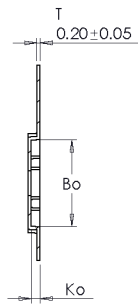

SECTION Y-Y  
SCALE 3.5 : 1

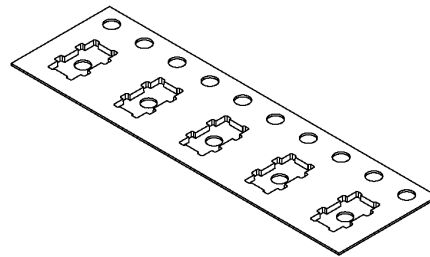
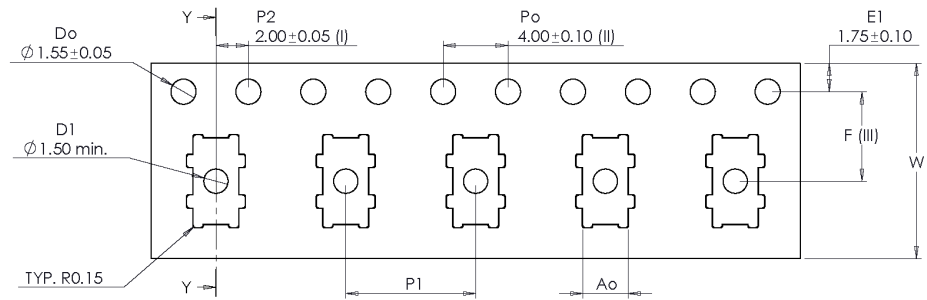

Ao	2.80	+/- 0.10
Bo	5.30	+/- 0.10
Ko	0.55	+/- 0.05
F	5.50	+/- 0.05
P1	8.00	+/- 0.10
W	12.00	+/- 0.30

Forming format : Press Form - 17  
Estimated max. length : 278 meter/22B3 reel

- (I) Measured from centreline of sprocket hole to centreline of pocket.
- (II) Cumulative tolerance of 10 sprocket holes is  $\pm 0.20$ .
- (III) Measured from centreline of sprocket hole to centreline of pocket.
- (IV) Other material available.

ALL DIMENSIONS IN MILLIMETRES UNLESS OTHERWISE STATED.

(1) 引脚 1 位于载带封装左上象限内（最靠近载带齿孔的位置）

## 重要声明

德州仪器(TI)及其下属子公司有权根据 JESD46 最新标准,对所提供的产品和服务进行更正、修改、增强、改进或其它更改,并有权根据 JESD48 最新标准中止提供任何产品和服务。客户在下订单前应获取最新的相关信息,并验证这些信息是否完整且是最新的。所有产品的销售都遵循在订单确认时所提供的TI 销售条款与条件。

TI 保证其所销售的组件的性能符合产品销售时 TI 半导体产品销售条件与条款的适用规范。仅在 TI 保证的范围内,且 TI 认为有必要时才会使用测试或其它质量控制技术。除非适用法律做出了硬性规定,否则没有必要对每种组件的所有参数进行测试。

TI 对应用帮助或客户产品设计不承担任何义务。客户应对其使用 TI 组件的产品和应用自行负责。为尽量减小与客户产品和应用相关的风险,客户应提供充分的设计与操作安全措施。

TI 不对任何 TI 专利权、版权、屏蔽作品权或其它与使用了 TI 组件或服务的组合设备、机器或流程相关的 TI 知识产权中授予的直接或隐含权限作出任何保证或解释。TI 所发布的与第三方产品或服务有关的信息,不能构成从 TI 获得使用这些产品或服务的许可、授权、或认可。使用此类信息可能需要获得第三方的专利权或其它知识产权方面的许可,或是 TI 的专利权或其它知识产权方面的许可。

对于 TI 的产品手册或数据表中 TI 信息的重要部分,仅在没有对内容进行任何篡改且带有相关授权、条件、限制和声明的情况下才允许进行复制。TI 对此类篡改过的文件不承担任何责任或义务。复制第三方的信息可能需要服从额外的限制条件。

在转售 TI 组件或服务时,如果对该组件或服务参数的陈述与 TI 标明的参数相比存在差异或虚假成分,则会失去相关 TI 组件或服务的所有明示或暗示授权,且这是不正当的、欺诈性商业行为。TI 对任何此类虚假陈述均不承担任何责任或义务。

客户认可并同意,尽管任何应用相关信息或支持仍可能由 TI 提供,但他们将独立负责满足与其产品及其在应用中使用的 TI 产品相关的所有法律、法规和安全相关要求。客户声明并同意,他们具备制定与实施安全措施所需的全部专业技术和知识,可预见故障的危险后果、监测故障及其后果、降低有可能造成人身伤害的故障的发生机率并采取适当的补救措施。客户将全额赔偿因在此类安全关键应用中使用任何 TI 组件而对 TI 及其代理造成的任何损失。

在某些场合中,为了推进安全相关应用有可能对 TI 组件进行特别的促销。TI 的目标是利用此类组件帮助客户设计和创立其特有的可满足适用的功能安全性标准和要求的终端产品解决方案。尽管如此,此类组件仍然服从这些条款。

TI 组件未获得用于 FDA Class III (或类似的生命攸关医疗设备)的授权许可,除非各方授权官员已经达成了专门管控此类使用的特别协议。

只有那些 TI 特别注明属于军用等级或“增强型塑料”的 TI 组件才是设计或专门用于军事/航空应用或环境的。购买者认可并同意,对并非指定面向军事或航空航天用途的 TI 组件进行军事或航空航天方面的应用,其风险由客户单独承担,并且由客户独立负责满足与此类使用相关的所有法律和法规要求。

TI 已明确指定符合 ISO/TS16949 要求的产品,这些产品主要用于汽车。在任何情况下,因使用非指定产品而无法达到 ISO/TS16949 要求, TI 不承担任何责任。

	产品		应用
数字音频	<a href="http://www.ti.com.cn/audio">www.ti.com.cn/audio</a>	通信与电信	<a href="http://www.ti.com.cn/telecom">www.ti.com.cn/telecom</a>
放大器和线性器件	<a href="http://www.ti.com.cn/amplifiers">www.ti.com.cn/amplifiers</a>	计算机及周边	<a href="http://www.ti.com.cn/computer">www.ti.com.cn/computer</a>
数据转换器	<a href="http://www.ti.com.cn/dataconverters">www.ti.com.cn/dataconverters</a>	消费电子	<a href="http://www.ti.com.cn/consumer-apps">www.ti.com.cn/consumer-apps</a>
DLP® 产品	<a href="http://www.dlp.com">www.dlp.com</a>	能源	<a href="http://www.ti.com.cn/energy">www.ti.com.cn/energy</a>
DSP - 数字信号处理器	<a href="http://www.ti.com.cn/dsp">www.ti.com.cn/dsp</a>	工业应用	<a href="http://www.ti.com.cn/industrial">www.ti.com.cn/industrial</a>
时钟和计时器	<a href="http://www.ti.com.cn/clockandtimers">www.ti.com.cn/clockandtimers</a>	医疗电子	<a href="http://www.ti.com.cn/medical">www.ti.com.cn/medical</a>
接口	<a href="http://www.ti.com.cn/interface">www.ti.com.cn/interface</a>	安防应用	<a href="http://www.ti.com.cn/security">www.ti.com.cn/security</a>
逻辑	<a href="http://www.ti.com.cn/logic">www.ti.com.cn/logic</a>	汽车电子	<a href="http://www.ti.com.cn/automotive">www.ti.com.cn/automotive</a>
电源管理	<a href="http://www.ti.com.cn/power">www.ti.com.cn/power</a>	视频和影像	<a href="http://www.ti.com.cn/video">www.ti.com.cn/video</a>
微控制器 (MCU)	<a href="http://www.ti.com.cn/microcontrollers">www.ti.com.cn/microcontrollers</a>		
RFID 系统	<a href="http://www.ti.com.cn/rfidsys">www.ti.com.cn/rfidsys</a>		
OMAP应用处理器	<a href="http://www.ti.com/omap">www.ti.com/omap</a>		
无线连通性	<a href="http://www.ti.com.cn/wirelessconnectivity">www.ti.com.cn/wirelessconnectivity</a>	德州仪器在线技术支持社区	<a href="http://www.deyisupport.com">www.deyisupport.com</a>

邮寄地址: 上海市浦东新区世纪大道1568号, 中建大厦32楼邮政编码: 200122  
Copyright © 2015, 德州仪器半导体技术(上海)有限公司

**PACKAGING INFORMATION**

Orderable Device	Status (1)	Package Type	Package Drawing	Pins	Package Qty	Eco Plan (2)	Lead finish/ Ball material (6)	MSL Peak Temp (3)	Op Temp (°C)	Device Marking (4/5)	Samples
CSD87588N	ACTIVE	PTAB	MPA	5	2500	RoHS & Green	NIPDAU	Level-1-260C-UNLIM	-55 to 150	87588N	Samples
CSD87588NT	ACTIVE	PTAB	MPA	5	250	RoHS & Green	NIPDAU	Level-1-260C-UNLIM	-55 to 150	87588N	Samples

(1) The marketing status values are defined as follows:

**ACTIVE:** Product device recommended for new designs.

**LIFEBUY:** TI has announced that the device will be discontinued, and a lifetime-buy period is in effect.

**NRND:** Not recommended for new designs. Device is in production to support existing customers, but TI does not recommend using this part in a new design.

**PREVIEW:** Device has been announced but is not in production. Samples may or may not be available.

**OBSOLETE:** TI has discontinued the production of the device.

(2) **RoHS:** TI defines "RoHS" to mean semiconductor products that are compliant with the current EU RoHS requirements for all 10 RoHS substances, including the requirement that RoHS substance do not exceed 0.1% by weight in homogeneous materials. Where designed to be soldered at high temperatures, "RoHS" products are suitable for use in specified lead-free processes. TI may reference these types of products as "Pb-Free".

**RoHS Exempt:** TI defines "RoHS Exempt" to mean products that contain lead but are compliant with EU RoHS pursuant to a specific EU RoHS exemption.

**Green:** TI defines "Green" to mean the content of Chlorine (Cl) and Bromine (Br) based flame retardants meet JS709B low halogen requirements of <=1000ppm threshold. Antimony trioxide based flame retardants must also meet the <=1000ppm threshold requirement.

(3) MSL, Peak Temp. - The Moisture Sensitivity Level rating according to the JEDEC industry standard classifications, and peak solder temperature.

(4) There may be additional marking, which relates to the logo, the lot trace code information, or the environmental category on the device.

(5) Multiple Device Markings will be inside parentheses. Only one Device Marking contained in parentheses and separated by a "~" will appear on a device. If a line is indented then it is a continuation of the previous line and the two combined represent the entire Device Marking for that device.

(6) Lead finish/Ball material - Orderable Devices may have multiple material finish options. Finish options are separated by a vertical ruled line. Lead finish/Ball material values may wrap to two lines if the finish value exceeds the maximum column width.

**Important Information and Disclaimer:**The information provided on this page represents TI's knowledge and belief as of the date that it is provided. TI bases its knowledge and belief on information provided by third parties, and makes no representation or warranty as to the accuracy of such information. Efforts are underway to better integrate information from third parties. TI has taken and continues to take reasonable steps to provide representative and accurate information but may not have conducted destructive testing or chemical analysis on incoming materials and chemicals. TI and TI suppliers consider certain information to be proprietary, and thus CAS numbers and other limited information may not be available for release.

In no event shall TI's liability arising out of such information exceed the total purchase price of the TI part(s) at issue in this document sold by TI to Customer on an annual basis.



## TAPE AND REEL INFORMATION



### QUADRANT ASSIGNMENTS FOR PIN 1 ORIENTATION IN TAPE



\*All dimensions are nominal

Device	Package Type	Package Drawing	Pins	SPQ	Reel Diameter (mm)	Reel Width W1 (mm)	A0 (mm)	B0 (mm)	K0 (mm)	P1 (mm)	W (mm)	Pin1 Quadrant
CSD87588N	PTAB	MPA	5	2500	330.0	12.4	2.8	5.3	0.55	8.0	12.0	Q1
CSD87588NT	PTAB	MPA	5	250	180.0	12.4	2.8	5.3	0.55	8.0	12.0	Q1

**TAPE AND REEL BOX DIMENSIONS**

\*All dimensions are nominal

Device	Package Type	Package Drawing	Pins	SPQ	Length (mm)	Width (mm)	Height (mm)
CSD87588N	PTAB	MPA	5	2500	367.0	367.0	35.0
CSD87588NT	PTAB	MPA	5	250	182.0	182.0	20.0

## 重要声明和免责声明

TI 均以“原样”提供技术性及其可靠性数据（包括数据表）、设计资源（包括参考设计）、应用或其他设计建议、网络工具、安全信息和其他资源，不保证其中不含任何瑕疵，且不做任何明示或暗示的担保，包括但不限于对适销性、适合某特定用途或不侵犯任何第三方知识产权的暗示担保。

所述资源可供专业开发人员应用TI 产品进行设计使用。您将对以下行为独自承担全部责任：(1) 针对您的应用选择合适的TI 产品；(2) 设计、验证并测试您的应用；(3) 确保您的应用满足相应标准以及任何其他安全、安保或其他要求。所述资源如有变更，恕不另行通知。TI 对您使用所述资源的授权仅限于开发资源所涉及TI 产品的相关应用。除此之外不得复制或展示所述资源，也不提供其它TI 或任何第三方的知识产权授权许可。如因使用所述资源而产生任何索赔、赔偿、成本、损失及债务等，TI 对此概不负责，并且您须赔偿由此对TI 及其代表造成的损害。

TI 所提供产品均受TI 的销售条款 (<http://www.ti.com.cn/zh-cn/legal/termsofsale.html>) 以及ti.com.cn上或随附TI产品提供的其他可适用条款的约束。TI提供所述资源并不扩展或以其他方式更改TI 针对TI 产品所发布的可适用的担保范围或担保免责声明。

邮寄地址：上海市浦东新区世纪大道 1568 号中建大厦 32 楼，邮政编码：200122

Copyright © 2020 德州仪器半导体技术（上海）有限公司