

DDR4 SDRAM Registered DIMM Based on 8Gb C-die

HMA81GR7CJR8N
HMA82GR7CJR8N
HMA82GR7CJR4N
HMA84GR7CJR4N

***SK hynix reserves the right to change products or specifications without notice.**

Revision History

Revision No.	History	Draft Date	Remark
0.1	Initial Release	Jul.2017	
1.0	IDD spec update	Aug.2017	
1.1	IDD spec correct	Sep.2017	
1.2	Corrected module dimensions P/N	Nov.2017	
1.3	Updated JEDEC Specification	Apr.2018	
1.4	Speed bin table note update	Apr.2018	
1.5	IDD spec update (speed 2933)	Aug.2018	
1.6	Define IDD Specification (speed 3200)	Mar.2019	
1.7	Correct Diagram of Module Dimension (4Gx72)	Aug.2019	No Design Change

Description

SK hynix Registered DDR4 SDRAM DIMMs (Registered Double Data Rate Synchronous DRAM Dual In-Line Memory Modules) are low power, high-speed operation memory modules that use DDR4 SDRAM devices. These Registered SDRAM DIMMs are intended for use as main memory when installed in systems such as servers and workstations.

Features

- Power Supply: VDD=1.2V (1.14V to 1.26V)
- VDDQ = 1.2V (1.14V to 1.26V)
- VPP - 2.5V (2.375V to 2.75V)
- VDDSPD=2.25V to 2.75V
- Functionality and operations comply with the DDR4 SDRAM datasheet
- 16 internal banks
- Bank Grouping is applied, and CAS to CAS latency (tCCD_L, tCCD_S) for the banks in the same or different bank group accesses are available
- Data transfer rates: PC4-3200, PC4-2933, 2666, PC4-2400, PC4-2133, PC4-1866, PC4-1600
- Bi-Directional Differential Data Strobe
- 8 bit pre-fetch
- Burst Length (BL) switch on-the-fly BL8 or BC4(Burst Chop)
- Supports ECC error correction and detection
- On-Die Termination (ODT)
- Temperature sensor with integrated SPD
- This product is in compliance with the RoHS directive.
- Per DRAM Addressability is supported
- Internal Vref DQ level generation is available
- Write CRC is supported at all speed grades
- DBI (Data Bus Inversion) is supported(x8)
- CA parity (Command/Address Parity) mode is supported

Ordering Information

Part Number	Density	Organization	Component Composition	# of ranks
HMA81GR7CJR8N-UH/VK/WM/XN	8GB	1Gx72	1Gx8(H5AN8G8NCJR)*9	1
HMA82GR7CJR8N-UH/VK/WM/XN	16GB	2Gx72	1Gx8(H5AN8G8NCJR)*18	2
HMA82GR7CJR4N-UH/VK/WM/XN	16GB	2Gx72	2Gx4(H5AN8G4NCJR)*18	1
HMA84GR7CJR4N-UH/VK/WM/XN	32GB	4Gx72	2Gx4(H5AN8G4NCJR)*36	2

Key Parameters

MT/s	Grade	tCK (ns)	CAS Latency (tCK)	tRCD (ns)	tRP (ns)	tRAS (ns)	tRC (ns)	CL-tRCD-tRP
DDR4-1600	-PB	1.25	11	13.75 (13.50)*	13.75 (13.50)*	35	48.75 (48.50)*	11-11-11
DDR4-1866	-RD	1.071	13	13.92 (13.50)*	13.92 (13.50)*	34	47.92 (47.50)*	13-13-13
DDR4-2133	-TF	0.937	15	14.06 (13.50)*	14.06 (13.50)*	33	47.06 (46.50)*	15-15-15
DDR4-2400	-UH	0.833	17	14.16 (13.75)*	14.16 (13.75)*	32	46.16 (45.75)*	17-17-17
DDR4-2666	-VK	0.75	19	14.25 (13.75)*	14.25 (13.75)*	32	46.25 (45.75)*	19-19-19
DDR4-2933	-WM	0.682	21	14.32 (13.75)*	14.32 (13.75)*	32	46.32 (45.75)*	21-21-21
DDR4-3200	-XN	0.625	22	13.75	13.75	32	47.0	22-22-22

*SK hynix DRAM devices support optional downbinning to CL21, CL19, CL17, CL17, CL15, CL13 and CL11. SPD setting is programm

Address Table

		8GB(1Rx8)	16GB(2Rx8)	16GB(1Rx4)	32GB(2Rx4)
Bank Address	# of Bank Groups	4	4	4	4
	BG Address	BG0~BG1	BG0~BG1	BG0~BG1	BG0~BG1
	Bank Address in a BG	BA0~BA1	BA0~BA1	BA0~BA1	BA0~BA1
Row Address		A0~A15	A0~A15	A0~A16	A0~A16
Column Address		A0~ A9	A0~ A9	A0~ A9	A0~ A9
Page size		1KB	1KB	512MB	512MB

Pin Descriptions

Pin Name	Description	Pin Name	Description
A0-A17 ¹	Register address input	SCL	I ² C serial bus clock for SPD-TSE and register
BA0, BA1	Register bank select input	SDA	I ² C serial data line for SPD-TSE and register
BG0, BG1	Register bank group select input	SA0-SA2	I ² C slave address select for SPD-TSE and register
RAS _n ²	Register row address strobe input	PAR	Register parity input
CAS _n ³	Register column address strobe input	VDD	SDRAM core power supply
WE _n ⁴	Register write enable input	C0, C1, C2	Chip ID lines for SDRAMx
CS0 _n , CS1 _n , CS2 _n , CS3 _n	DIMM Rank Select Lines input	12V	Optional Power Supply on socket but not used on RDIMM
CKE0, CEK1	Register clock enable lines input	VREFCA	SDRAM command/address reference supply
ODT0, ODT1	Register on-die termination control lines input	VSS	Power supply return (ground)
ACT _n	Register input for activate input	VDDSPD	Serial SPD/TS positive power supply
DQ0-DQ63	DIMM memory data bus	ALERT _n	Register ALERT _n output
CB0-CB7	DIMM ECC check bits	VPP	SDRAM Supply
TDQS9 _t -TDQS17 _t TDQS9 _c -TDQS17 _c	Dummy loads for mixed populations of x4 based and x8 based RDIMMs.		
DQS0 _t -DQS17 _t	Data Buffer data strobes (positive line of differential pair)	DM0 _n -DM8 _n	Data Mask
DQS0 _c -DQS17 _c	Data Buffer data strobes (negative line of differential pair)	RESET _n	Set Register and SDRAMs to a Known State
DBI0 _n -DBI8 _n	Data Bus Inversion	EVENT _n	SPD signals a thermal event has occurred
CK0 _t , CK1 _t	Register clock input (positive line of differential pair)	VTT	SDRAM I/O termination supply
CK0 _c , CK1 _c	Register clocks input (negative line of differential pair)	RFU	Reserved for future use

1. Address A17 is only valid for 16Gbx4 based SDRAMs.
2. RAS_n is a multiplexed function with A16.
3. CAS_n is a multiplexed function with A15.
4. WE_n is a multiplexed function with A14.

Input/Output Functional Descriptions

Symbol	Type	Function
CK0_t, CK0_c, CK1_t, CK1_c	Input	Clock: CK_t and CK_c are differential clock inputs. All address and control input signals are sampled on the crossing of the positive edge of CK_t and negative edge of CK_c.
CKE0, CKE1	Input	Clock Enable: CKE HIGH activates, and CKE LOW deactivates internal clock signals and device input buffers and output drivers. Taking CKE LOW provides Precharge Power-Down and Self-Refresh operation (all banks idle), or Active Power-Down (row Active in any bank). CKE is synchronous for Self-Refresh exit. After VREFCA and Internal DQ Vref have become stable during the power on and initialization sequence, they must be maintained during all operations (including Self-Refresh). CKE must be maintained high throughout read and write accesses. Input buffers, excluding CK_t, CK_c, ODT and CKE, are disabled during power-down. Input buffers, excluding CKE, are disabled during Self-Refresh.
CS0_n, CS1_n, CS2_n, CS3_n	Input	Chip Select: All commands are masked when CS_n is registered HIGH. CS_n provides for external Rank selection. CS_n is considered part of the command code.
C0, C1, C2	Input	Chip ID: Chip ID is only used for 3DS for 2,4,8 high stack via TSV to select each slice of stacked component. Chip ID is considered part of the command code.
ODT0, ODT1	Input	On-Die Termination: ODT (registered HIGH) enables RTT_NOM termination resistance internal to the DDR4 SDRAM. When enabled, ODT is only applied to each DQ, DQS_t, DQS_c, TDQS_t, and TDQS_c signal. The ODT pin will be ignored if MR1 is programmed to disable RTT_NOM.
ACT_n	Input	Activation Command Input: ACT_n defines the Activation command being entered along with CS_n. The input into RAS_n/A16, CAS_n/A15, and WE_n/A14 will be considered as Row Address A16, A15, and A14.
RAS_n/A16, CAS_n/A15, WE_n/A14	Input	Command Inputs: RAS_n/A16, CAS_n/A15, and WE_n/A14 (along with CS_n) define the command being entered. Those pins are multi-function. For example, for activation with ACT_n Low, these are Addresses like A16, A15, and A14, but for non-activation command with ACT_n High, these are Command pins for Read, Write, and other commands defined in command truth table.
BG0 - BG1	Input	Bank Group Inputs: BG0 - BG1 define to which bank group an Active, Read, Write, or Precharge command is being applied. BG0 also determines which mode register is to be accessed during a MRS cycle.
BA0 - BA1	Input	Bank Address Inputs: BA0 - BA1 define to which bank an Active, Read, Write, or Precharge command is being applied. Bank address also determines which mode register is to be accessed during a MRS cycle.
A0 - A17	Input	Address Inputs: Provide the row address for ACTIVATE Commands and the column address for Read/Write commands to select one location out of the memory array in the respective bank. A10/AP, A12/BC_n, RAS_n/A16, CAS_n/A15 and WE_n/A14 have additional functions. See other rows. The address inputs also provide the op-code during Mode Register Set commands. A17 is only defined for 16Gb x4 SDRAM configurations.

Symbol	Type	Function
A10 / AP	Input	Auto-precharge: A10 is sampled during Read/Write commands to determine whether Autoprecharge should be performed to the accessed bank after the Read/Write operation. (HIGH: Autoprecharge; LOW: no Autoprecharge). A10 is sampled during a Precharge command to determine whether the Precharge applies to one bank (A10 LOW) or all banks (A10 HIGH). If only one bank is to be precharged, the bank is selected by bank addresses.
A12 / BC_n	Input	Burst Chop: A12 / BC_n is sampled during Read and Write commands to determine if burst chop (on-the-fly) will be performed. (HIGH, no burst chop; LOW: burst chopped). See command truth table for details.
RESET_n	CMOS Input	Active Low Asynchronous Reset: Reset is active when RESET_n is LOW, and inactive when RESET_n is HIGH. RESET_n must be HIGH during normal operation.
DQ	Input / Output	Data Input/ Output: Bi-directional data bus. If CRC is enabled via Mode register, then CRC code is added at the end of Data Burst. Any DQ from DQ0-DQ3 may indicate the internal Vref level during test via Mode Register Setting MR4 A4=High. Refer to vendor specific data sheets to determine which DQ is used.
DQS0_t-DQS17_t, DQS0_c-DQS17_c	Input / Output	Data Strobe: output with read data, input with write data. Edge-aligned with read data, centered in write data. The data strobe DQS_t is paired with differential signals DQS_c, respectively, to provide differential pair signaling to the system during reads and writes. DDR4 SDRAM supports differential data strobe only and does not support single-ended.
TDQS9_t-TDQS17_t, TDQS9_c-TDQS17_c	Input	Provides a dummy load for x8 based RDIMMs where mixed populations of x4 and x8 based RDIMMs are present.
DBI0_n-DBI8_n	Input / Output	Provides for data bus inversion. Only possible for x8 based RDIMMs and where only x8 based RDIMMs are on a channel.
DM0_n-DM8_n	Input	Provides for masking of a byte on WRITE commands to the SDRAMs. Only Possible x8 based RDIMMs and where only x8 based RDIMMs are on a channel.
PAR	Input	Command and Address Parity Input : DDR4 Supports Even Parity check in SDRAMs with MR setting. Once it's enabled via Register in MR5, then SDRAM calculates Parity with ACT_n, RAS_n/A16, CAS_n/A15, WE_n/A14, BG0-BG1, BA0-BA1, A17-A0. Input parity should be maintained at the rising edge of the clock and at the same time as command & address, with CS_n LOW.
ALERT_n	Output (Input)	Alert: Is multi functions, such as CRC error flag or Command and Address Parity error flag, as on Output signal. If there is an error in the CRC, then ALERT_n goes LOW for the period time interval and goes back HIGH. If there is an error in the Command Address Parity Check, then ALERT_n goes LOW for a relatively long period until on going SDRAM internal recovery transaction is complete. During Connectivity Test mode, this pin functions as an input. Using this signal or not is dependent on the system.
RFU		Reserved for Future Use: No on-DIMM electrical connection is present.
NC		No Connect: No on-DIMM electrical connection is present.
VDD ¹	Supply	Power Supply: 1.2 V ± 0.06 V
VSS	Supply	Ground

Symbol	Type	Function
VTT	Supply	Power Supply for termination of Address, Command and Control, VDD/2.
12V	Supply	12V supply not used on RDIMMs.
VPP	Supply	SDRAM Activating Power Supply: 2.5V (2.375V min , 2.75V max)
VDDSPD	Supply	Power supply used to power the I2C bus on the SPD-TSE and register.
VREFCA	Supply	Reference voltage for CA

Note: For PC4, VDD is 1.2V. For PC4L, VDD is TBD.

Pin Assignments

Pin	Front Side Pin Label	Pin	Back Side Pin Label	Pin	Front Side Pin Label	Pin	Back Side Pin Label
1	NC	145	NC	74	CK0_t	218	CK1_t
2	VSS	146	VREFCA	75	CK0_c	219	CK1_c
3	DQ4	147	VSS	76	VDD	220	VDD
4	VSS	148	DQ5	77	VTT	221	VTT
5	DQ0	149	VSS	KEY			
6	VSS	150	DQ1				
7	TDQS9_t, DQS9_t, DM0_n, DBI0_n	151	VSS	78	EVENT_n	222	PARITY
8	TDQS9_c, DQS9_c	152	DQS0_c	79	A0	223	VDD
9	VSS	153	DQS0_t	80	VDD	224	BA1
10	DQ6	154	VSS	81	BA0	225	A10/AP
11	VSS	155	DQ7	82	RAS_n/A16	226	VDD
12	DQ2	156	VSS	83	VDD	227	RFU
13	VSS	157	DQ3	84	CS0_n	228	WE_n/A14
14	DQ12	158	VSS	85	VDD	229	VDD
15	VSS	159	DQ13	86	CAS_n/A15	230	NC
16	DQ8	160	VSS	87	ODT0	231	VDD
17	VSS	161	DQ9	88	VDD	232	A13
18	TDQS10_t, DQS10_t, DM1_n, DBI1_n	162	VSS	89	CS1_n, NC	233	VDD
19	TDQS10_c, DQS10_c	163	DQS1_c	90	VDD	234	A17
20	VSS	164	DQS1_t	91	ODT1, NC	235	NC, C2
21	DQ14	165	VSS	92	VDD	236	VDD
22	VSS	166	DQ15	93	C0, CS2_n, NC	237	NC, CS3_n, C1
23	DQ10	167	VSS	94	VSS	238	SA2
24	VSS	168	DQ11	95	DQ36	239	VSS
25	DQ20	169	VSS	96	VSS	240	DQ37
26	VSS	170	DQ21	97	DQ32	241	VSS
27	DQ16	171	VSS	98	VSS	242	DQ33
28	VSS	172	DQ17	99	TDQS13_t, DQS13_t, DM4_n, DBI4_n	243	VSS
29	TDQS11_t, DQS11_t, DM2_n, DBI2_n	173	VSS	100	TDQS13_c, DQS13_c	244	DQS4_c
30	TDQS11_c, DQS11_c	174	DQS2_c	101	VSS	245	DQS4_t
31	VSS	175	DQS2_t	102	DQ38	246	VSS
32	DQ22	176	VSS	103	VSS	247	DQ39
33	VSS	177	DQ23	104	DQ34	248	VSS
34	DQ18	178	VSS	105	VSS	249	DQ35
35	VSS	179	DQ19	106	DQ44	250	VSS
36	DQ28	180	VSS	107	VSS	251	DQ45

Pin	Front Side Pin Label	Pin	Back Side Pin Label	Pin	Front Side Pin Label	Pin	Back Side Pin Label
37	VSS	181	DQ29	108	DQ40	252	VSS
38	DQ24	182	VSS	109	VSS	253	DQ41
39	VSS	183	DQ25	110	TDQS14_t, DQS14_t, DM5_n, DBI5_n	254	VSS
40	TDQS12_t, DQS12_t, DM3_n, DBI3_n	184	VSS	111	TDQS14_c, DQS14_c	255	DQS5_c
41	TDQS12_c, DQS12_c	185	DQS3_c	112	VSS	256	DQS5_t
42	VSS	186	DQS3_t	113	DQ46	257	VSS
43	DQ30	187	VSS	114	VSS	258	DQ47
44	VSS	188	DQ31	115	DQ42	259	VSS
45	DQ26	189	VSS	116	VSS	260	DQ43
46	VSS	190	DQ27	117	DQ52	261	VSS
47	CB4	191	VSS	118	VSS	262	DQ53
48	VSS	192	CB5	119	DQ48	263	VSS
49	CB0	193	VSS	120	VSS	264	DQ49
50	VSS	194	CB1	121	TDQS15_t, DQS15_t, DM6_n, DBI6_n	265	VSS
51	TDQS17_t, DQS17_t, DM8_n, DBI8_n	195	VSS	122	TDQS15_c, DQS15_c	266	DQS6_c
52	TDQS17_c, DQS17_c	196	DQS8_c	123	VSS	267	DQS6_t
53	VSS	197	DQS8_t	124	DQ54	268	VSS
54	CB6	198	VSS	125	VSS	269	DQ55
55	VSS	199	CB7	126	DQ50	270	VSS
56	CB2	200	VSS	127	VSS	271	DQ51
57	VSS	201	CB3	128	DQ60	272	VSS
58	RESET_n	202	VSS	129	VSS	273	DQ61
59	VDD	203	CKE1, NC	130	DQ56	274	VSS
60	CKE0	204	VDD	131	VSS	275	DQ57
61	VDD	205	RFU	132	TDQS16_t, DQS16_t, DM7_n, DBI7_n	276	VSS
62	ACT_n	206	VDD	133	TDQS16_c, DQS16_c	277	DQS7_c
63	BG0	207	BG1	134	VSS	278	DQS7_t
64	VDD	208	ALERT_n	135	DQ62	279	VSS
65	A12/BC_n	209	VDD	136	VSS	280	DQ63
66	A9	210	A11	137	DQ58	281	VSS
67	VDD	211	A7	138	VSS	282	DQ59
68	A8	212	VDD	139	SA0	283	VSS
69	A6	213	A5	140	SA1	284	VDDSPD
70	VDD	214	A4	141	SCL	285	SDA
71	A3	215	VDD	142	VPP	286	VPP
72	A1	216	A2	143	VPP	287	VPP
73	VDD	217	VDD	144	RFU	288	VPP

Functional Block Diagram

8GB, 1Gx72 Module(1Rank of x8) - page1

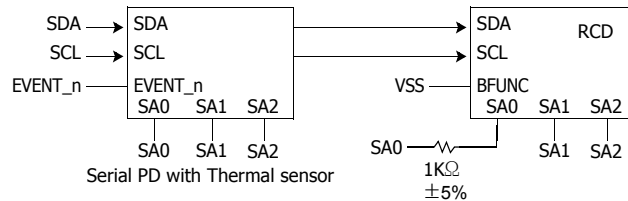
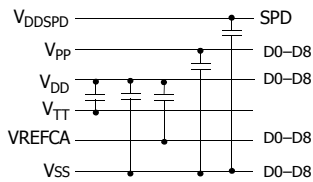
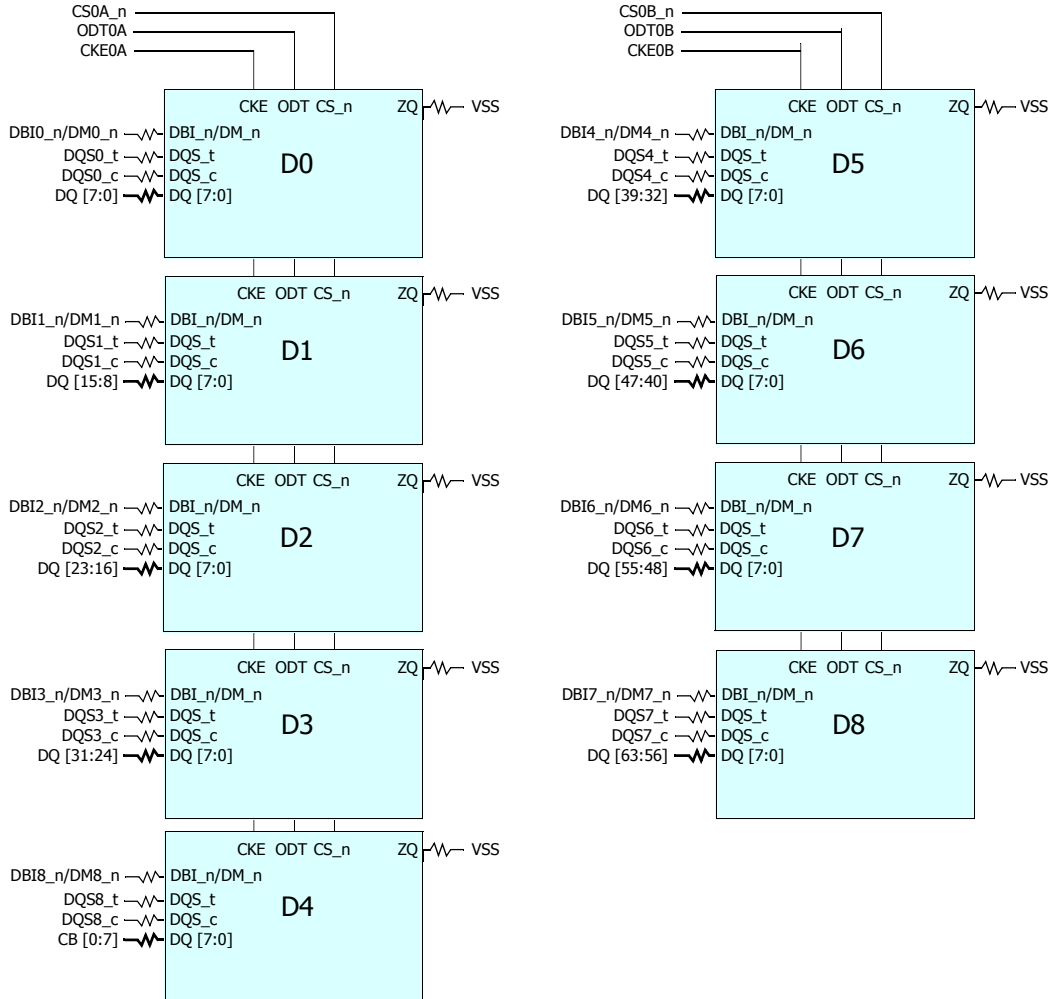

Note:

1. Unless otherwise noted, resistor values are 15Ω ±5%.
2. See the Net Structure diagrams for all resistor associated with the command, address and control bus.
3. ZQ resistors are 240Ω ±1%. For all other resistor values refer to the appropriate wiring diagram.
4. The TEN pin on the SDRAMs are tied to VSS.
5. VDD and VDDSPD also connect with the register.

8GB, 1Gx72x72 Module(1Rank of x8) - page2

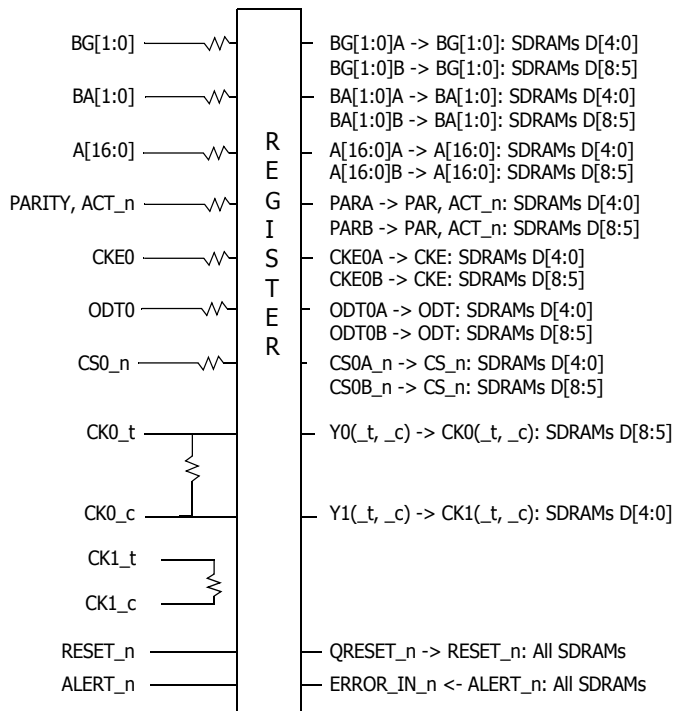

Note:

1. CK0_t, CK0_c terminated with $120\Omega \pm 5\%$ resistor.
2. CK1_t, CK1_c terminated with $120\Omega \pm 5\%$ resistor but not used.
3. Unless otherwise noted resistors are $22\Omega \pm 5\%$.
4. Register inputs CS1_n, CS2_n/C0 and CS3_n/C1 are tied to VDD. Register inputs CS, ODT1 and CKE1 are tied to VSS.

16GB, 2Gx72 Module(2Rank of x8) - page1

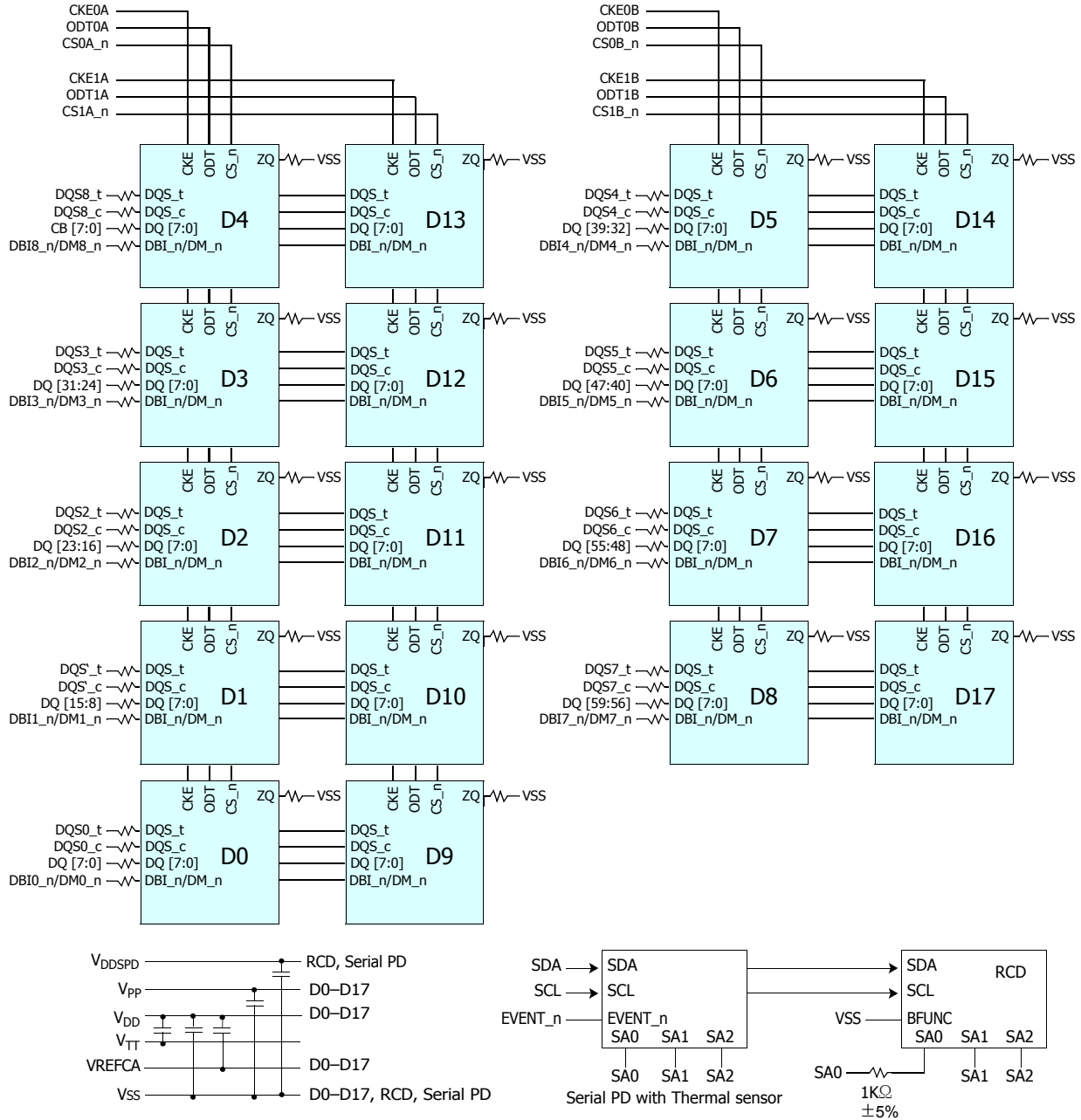

Note:

1. Unless otherwise noted, resistor values are 15Ω ±5%.
2. See the Net Structure diagrams for all resistor associated with the command, address and control bus.
3. ZQ resistors are 240Ω ±1%. For all other resistor values refer to the appropriate wiring diagram.
4. The TEN pin on the SDRAMs are tied to V_{SS}.
5. V_{DD} and V_{DDSPD} also connect to the RCD

16GB, 2Gx72 Module(2Rank of x8) - page2

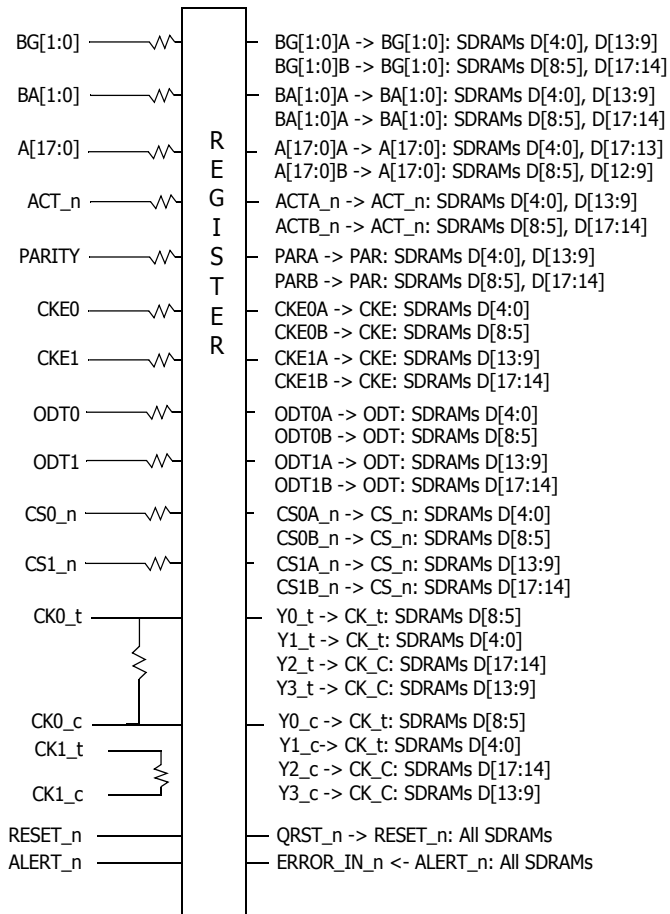

Note:

1. CK0_t, CK0_c terminated with 120Ω ±5% resistor.
2. CK1_t, CK1_c terminated with 120Ω ±5% resistor but not used.
3. Unless otherwise noted resistors are 22Ω ±5%.

16GB, 2Gx72 Module(1Rank of x4) - page1

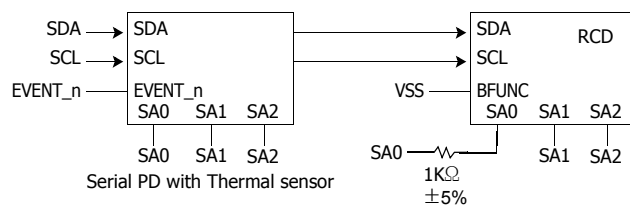
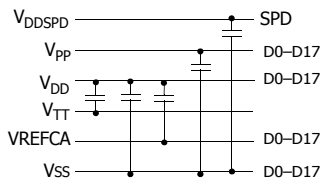
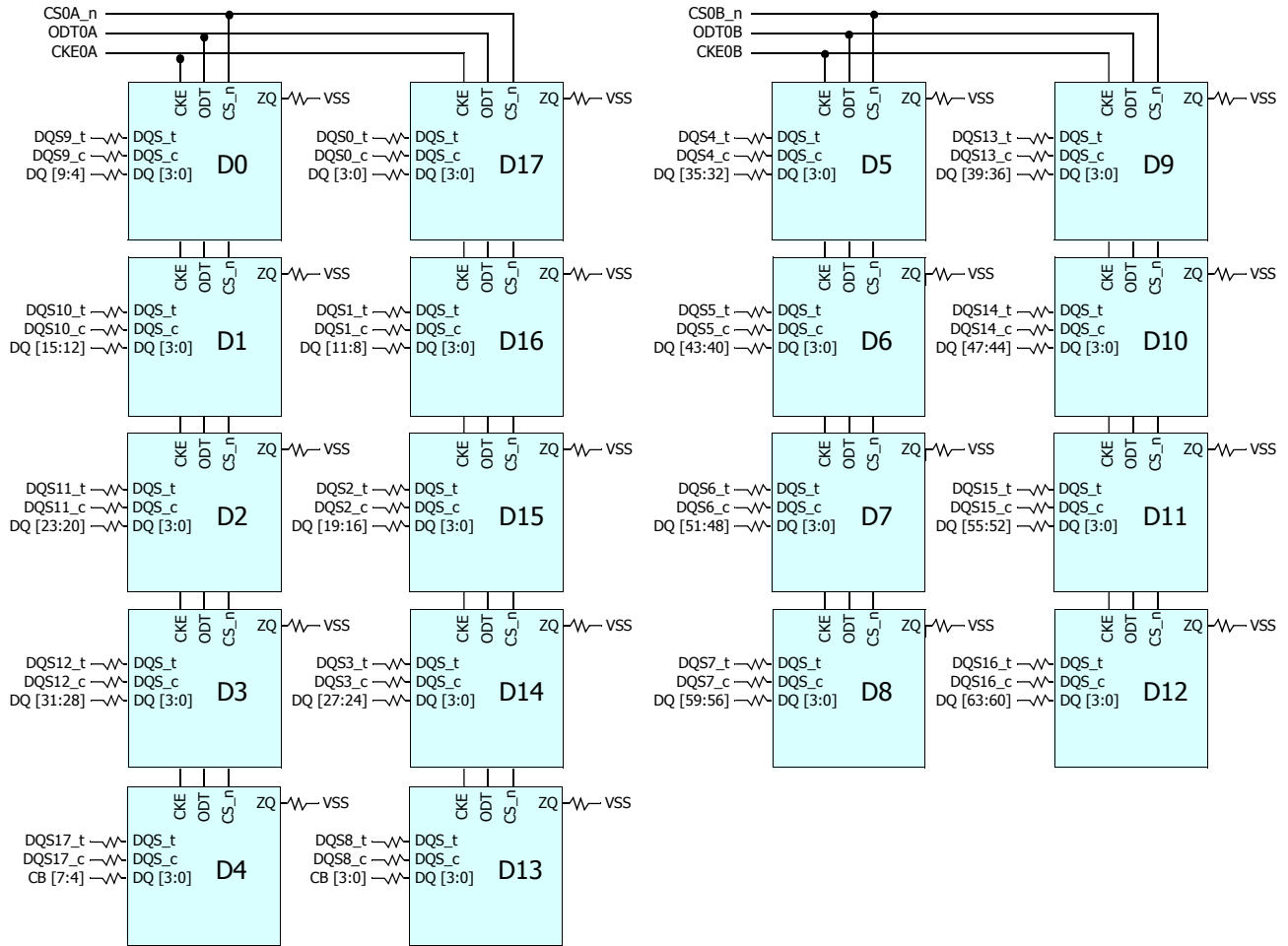

Note:

1. Unless otherwise noted, resistor values are 15Ω ±5%.
2. See the Net Structure diagrams for all resistor associated with the command, address and control bus.
3. ZQ resistors are 240Ω ±1%. For all other resistor values refer to the appropriate wiring diagram.
4. VDD and VDDSPD also connect to the register. TEN pin of SDRAMs is tied to VSS.

16GB, 2Gx72 Module(1Rank of x4) - page2

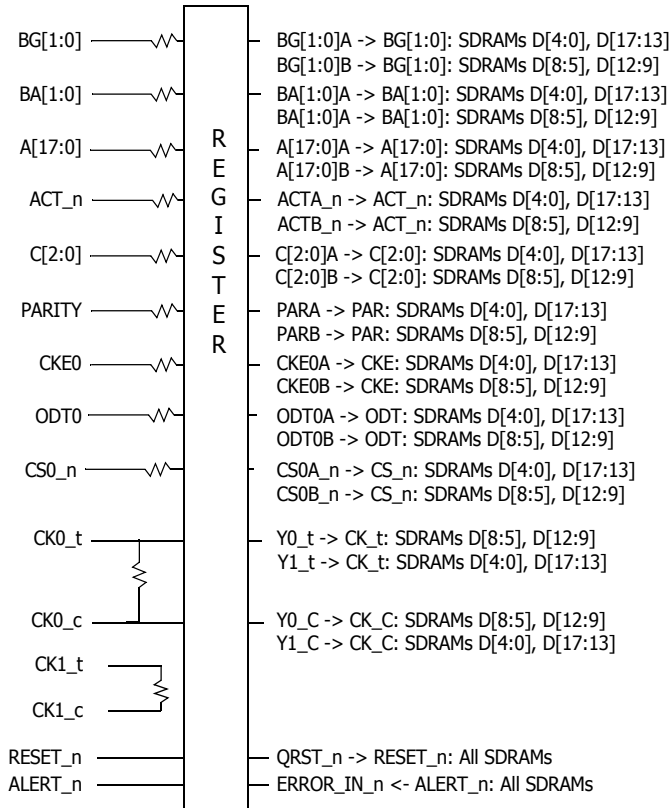

Note:

1. CK0_t, CK0_c terminated with 120 Ω \pm 5% resistor.
2. CK1_t, CK1_c terminated with 120 Ω \pm 5% resistor but not used.
3. Unless otherwise noted resistors are 22 Ω \pm 5%.
4. Register input CS1_n is tied to VDD. Register inputs ODT1 and CKE1 are tied to VSS.

32GB, 4Gx72 Module(2Rank of x4) - page1

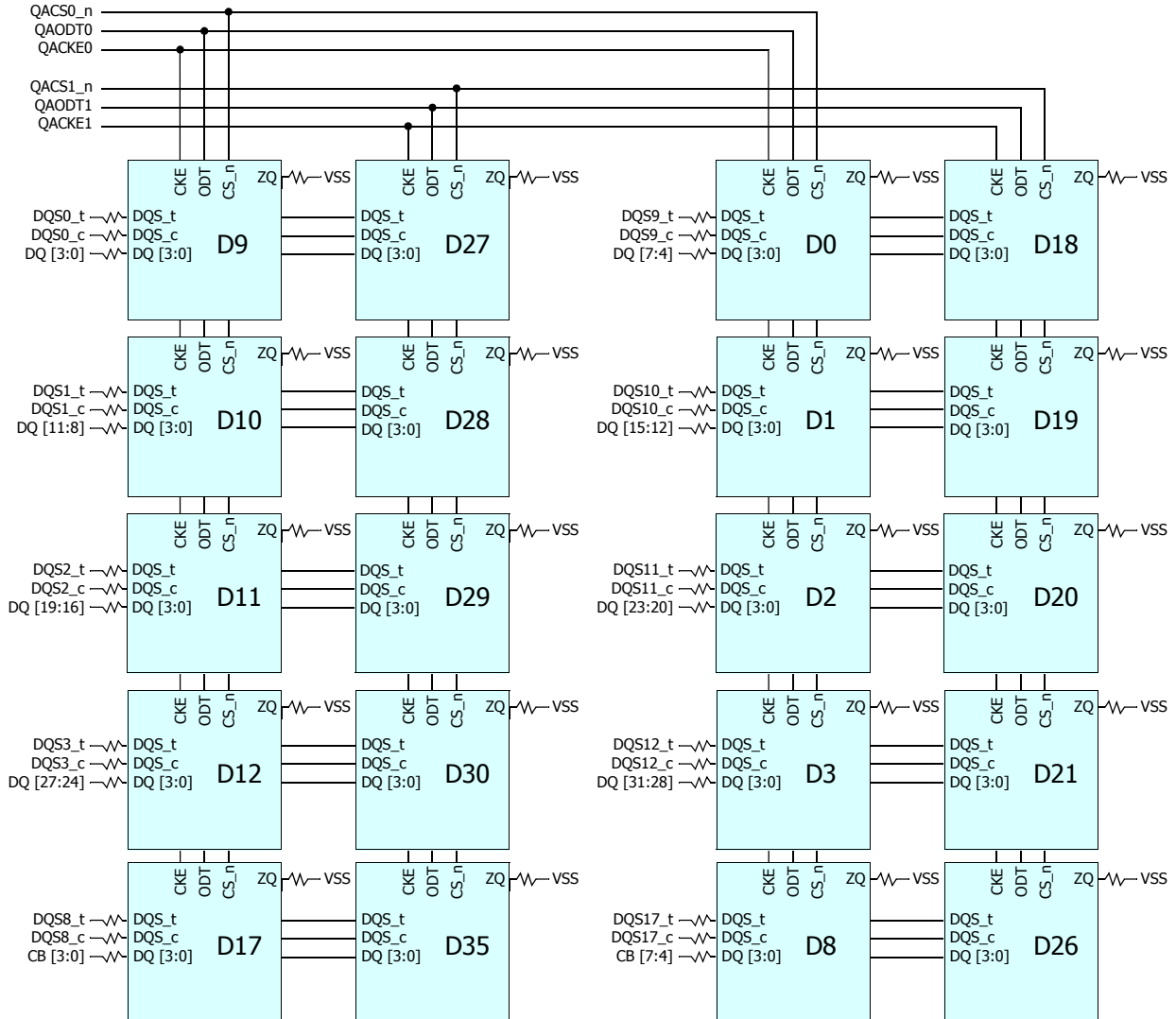

Note:

1. Unless otherwise noted, resistor values are $15\Omega \pm 5\%$.
2. See the Net Structure diagrams for all resistor associated with the command, address and control bus.
3. ZQ resistors are $240\Omega \pm 1\%$. For all other resistor values refer to the appropriate wiring diagram.
4. DRAM TEN pin need to be tied to VSS.
5. VDDSPD also connects to the register (RCD).
6. VREFCA from the edge connector only connects with the register (RCD). The RCD sources a separate VREFCA to all the SDRAMs.

32GB, 4Gx72 Module(2Rank of x4) - page2

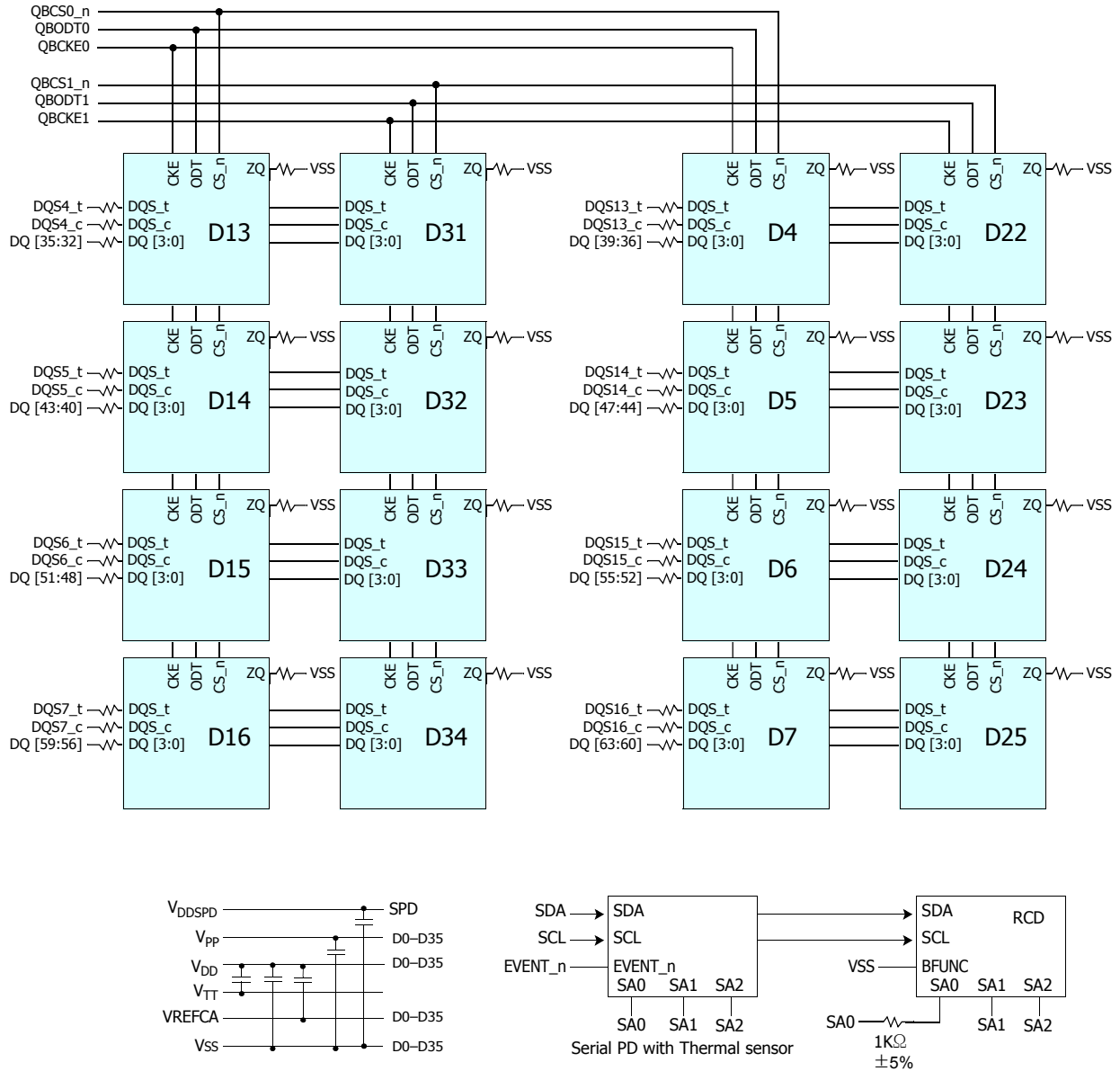

Note:

1. Unless otherwise noted, resistor values are $15\Omega \pm 5\%$.
2. See the Net Structure diagrams for all resistor associated with the command, address and control bus.
3. ZQ resistors are $240\Omega \pm 1\%$. For all other resistor values refer to the appropriate wiring diagram.
4. DRAM TEN pin need to be tied to VSS.
5. VDDSPD also connects to the register (RCD).
6. VREFCA from the edge connector only connects with the register (RCD). The RCD sources a separate VREFCA to all the SDRAMs.

32GB, 4Gx72 Module(2Rank of x4) - page3

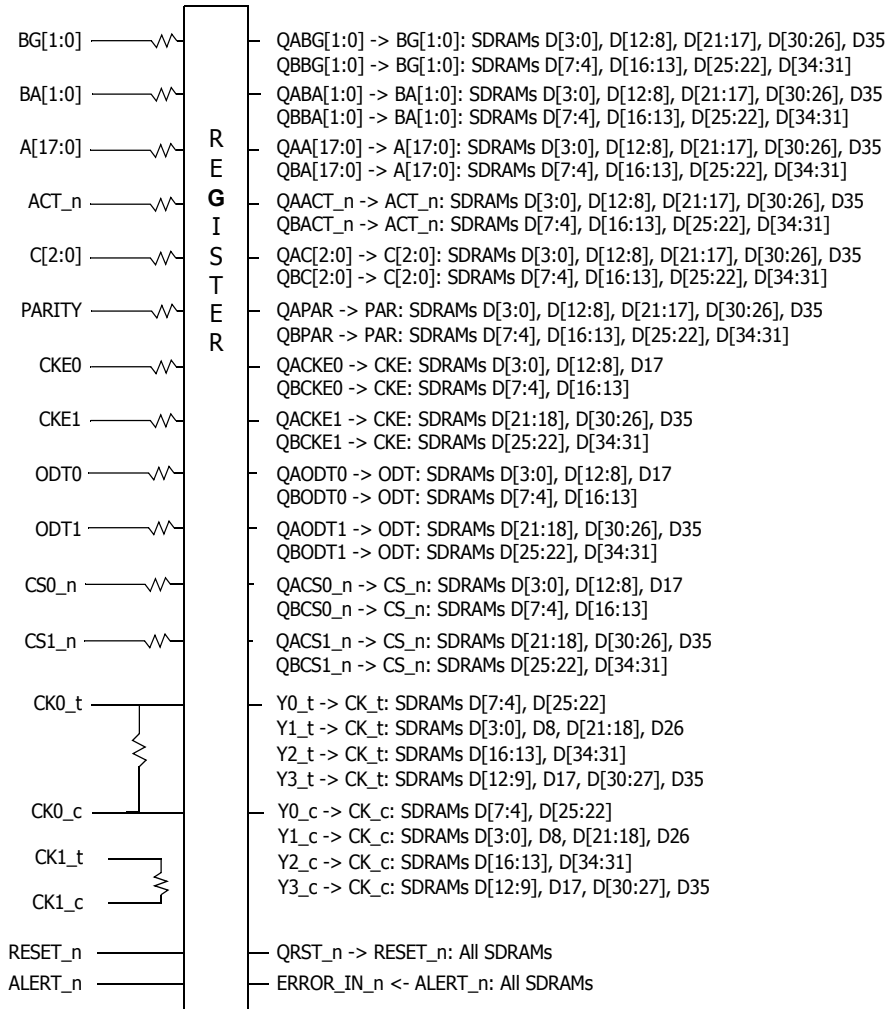

Note:

1. CK0_t, CK0_c terminated with 120 Ω \pm 5% resistor.
2. CK1_t, CK1_c terminated with 120 Ω \pm 5% resistor but not used.
3. Unless otherwise noted resistors are 22 Ω \pm 5%.

Absolute Maximum Ratings

Absolute Maximum DC Ratings

Absolute Maximum DC Ratings

Symbol	Parameter	Rating	Units	NOTE
VDD	Voltage on VDD pin relative to Vss	-0.3 ~ 1.5	V	1,3
VDDQ	Voltage on VDDQ pin relative to Vss	-0.3 ~ 1.5	V	1,3
VPP	Voltage on VPP pin relative to Vss	-0.3 ~ 3.0	V	4
V _{IN} , V _{OUT}	Voltage on any pin except VREFCA relative to Vss	-0.3 ~ 1.5	V	1,3,5
T _{STG}	Storage Temperature	-55 to +100	°C	1,2

NOTE :

- Stresses greater than those listed under "Absolute Maximum Ratings" may cause permanent damage to the device. This is a stress rating only and functional operation of the device at these or any other conditions above those indicated in the operational sections of this specification is not implied. Exposure to absolute maximum rating conditions for extended periods may affect reliability
- Storage Temperature is the case surface temperature on the center/top side of the DRAM. For the measurement conditions, please refer to JESD51-2 standard.
- VDD and VDDQ must be within 300 mV of each other at all times; and VREFCA must be not greater than 0.6 x VDDQ, When VDD and VDDQ are less than 500 mV; VREFCA may be equal to or less than 300 mV
- VPP must be equal or greater than VDD/VDDQ at all times
- Overshoot area above 1.5V is specified in DDR4 Device Operation.

DRAM Component Operating Temperature Range

Temperature Range

Symbol	Parameter	Rating	Units	Notes
T _{OPER}	Normal Operating Temperature Range	0 to 85	°C	1,2
	Extended Temperature Range	85 to 95	°C	1,3

NOTE:

- Operating Temperature TOPER is the case surface temperature on the center / top side of the DRAM. For measurement conditions, please refer to the JEDEC document JEDEC51-2.
- The Normal Temperature Range specifies the temperatures where all DRAM specifications will be supported. During operation, the DRAM case temperature must be maintained between 0 - 85°C under all operating conditions.
- Some applications require operation of the DRAM in the Extended Temperature Range between 85°C and 95°C case temperature. Full specifications are guaranteed in this range, but the following additional conditions apply:
 - Refresh commands must be doubled in frequency, therefore reducing the Refresh interval tREFI to 3.9 μs. It is also possible to specify a component with 1X refresh (tREFI to 7.8μs) in the Extended Temperature Range. Please refer to the DIMM SPD for option availability
 - If Self-Refresh operation is required in the Extended Temperature Range, then it is mandatory to either use the Manual Self-Refresh mode with Extended Temperature Range capability (MR2 A6 = 0b and MR2 A7 = 1b) or enable the optional Auto Self-Refresh mode (MR2 A6 = 1b and MR2 A7 = 0b).

AC & DC Operating Conditions

Recommended DC Operating Conditions

Recommended DC Operating Conditions

Symbol	Parameter	Rating			Unit	NOTE
		Min.	Typ.	Max.		
VDD	Supply Voltage	1.14	1.2	1.26	V	1,2,3
VDDQ	Supply Voltage for Output	1.14	1.2	1.26	V	1,2,3
VPP	Supply Voltage for DRAM Activating	2.375	2.5	2.75	V	3

NOTE:

1. Under all conditions VDDQ must be less than or equal to VDD.
2. VDDQ tracks with VDD. AC parameters are measured with VDD and VDDQ tied together.
3. DC bandwidth is limited to 20MHz.

AC & DC Input Measurement Levels

AC & DC Logic input levels for single-ended signals

Single-ended AC & DC input levels for Command and Address

Symbol	Parameter	DDR4-1600/1866/2133/ 2400		DDR4-2666/2933/3200		Unit	NOTE
		Min.	Max.	Min.	Max.		
$V_{IH.CA}(DC75)$	DC input logic high	$V_{REFCA}^+ - 0.075$	VDD	$V_{REFCA}^+ - 0.065$	VDD	V	
$V_{IL.CA}(DC75)$	DC input logic low	VSS	$V_{REFCA}^- - 0.075$	VSS	$V_{REFCA}^- - 0.065$	V	
$V_{IH.CA}(AC100)$	AC input logic high	$V_{REF} + 0.1$	Note 2	$V_{REF} + 0.09$	Note 2	V	1
$V_{IL.CA}(AC100)$	AC input logic low	Note 2	$V_{REF} - 0.1$	Note 2	$V_{REF} - 0.09$	V	1
$V_{REFCA}(DC)$	Reference Voltage for ADD, CMD inputs	$0.49 \cdot VDD$	$0.51 \cdot VDD$	$0.49 \cdot VDD$	$0.51 \cdot VDD$	V	2,3

NOTE :

1. See "Overshoot and Undershoot Specifications"
2. The AC peak noise on VREFCA may not allow VREFCA to deviate from VREFCA(DC) by more than $\pm 1\%$ VDD (for reference : approx. $\pm 12mV$)
3. For reference : approx. $VDD/2 \pm 12mV$

AC and DC Input Measurement Levels: V_{REF} Tolerances

The DC-tolerance limits and ac-noise limits for the reference voltages V_{REFCA} is illustrated in Figure below. It shows a valid reference voltage $V_{REF}(t)$ as a function of time. (V_{REF} stands for V_{REFCA}).

$V_{REF}(DC)$ is the linear average of $V_{REF}(t)$ over a very long period of time (e.g. 1 sec). This average has to meet the min/max requirement in Table X. Furthermore $V_{REF}(t)$ may temporarily deviate from $V_{REF}(DC)$ by no more than $\pm 1\% V_{DD}$.

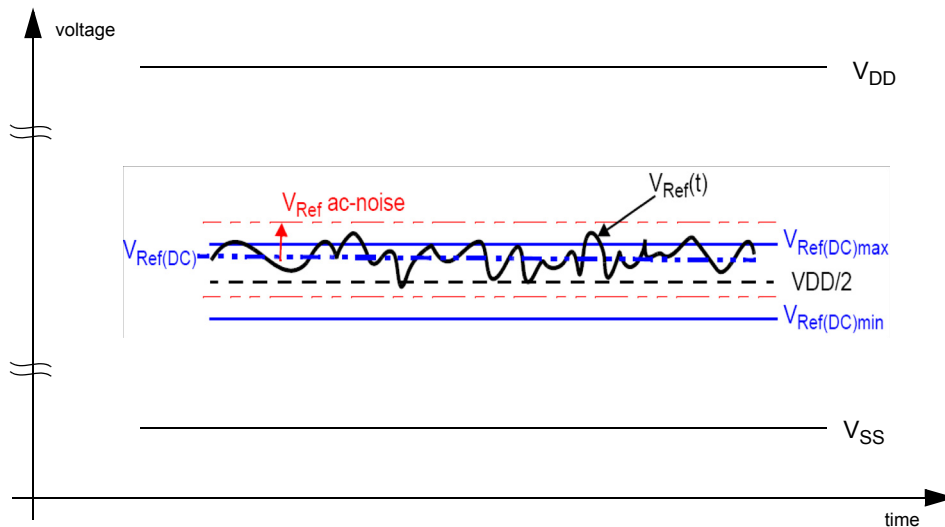

Illustration of $V_{REF}(DC)$ tolerance and V_{REF} AC-noise limits

The voltage levels for setup and hold time measurements $V_{IH}(AC)$, $V_{IH}(DC)$, $V_{IL}(AC)$ and $V_{IL}(DC)$ are dependent on V_{REF} .

" V_{REF} " shall be understood as $V_{REF}(DC)$, as defined in Figure above.

This clarifies, that DC-variations of V_{REF} affect the absolute voltage a signal has to reach to achieve a valid high or low level and therefore the time to which setup and hold is measured. System timing and voltage budgets need to account for $V_{REF}(DC)$ deviations from the optimum position within the data-eye of the input signals.

This also clarifies that the DRAM setup/hold specification and derating values need to include time and voltage associated with V_{REF} AC-noise. Timing and voltage effects due to AC-noise on V_{REF} up to the specified limit ($\pm 1\%$ of V_{DD}) are included in DRAM timings and their associated deratings.

AC and DC Logic Input Levels for Differential Signals

Differential signal definition

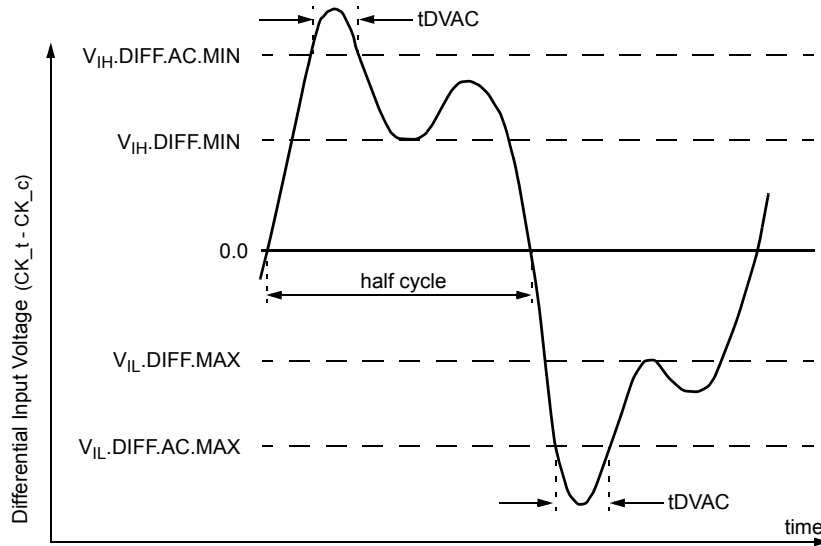

NOTE:

1. Differential signal rising edge from $V_{IL.DIFF.MAX}$ to $V_{IH.DIFF.MIN}$ must be monotonic slope.
2. Differential signal falling edge from $V_{IH.DIFF.MIN}$ to $V_{IL.DIFF.MAX}$ must be monotonic slope.

Definition of differential ac-swing and "time above ac-level" t_{DVAC}

Differential swing requirements for clock (CK_t - CK_c) Differential AC and DC Input Levels

Symbol	Parameter	DDR4 - 1600,1866,2133		DDR4 -2400		DDR4 -2666		DDR4 -2933		DDR4 -3200		unit	NOTE
		min	max	min	max	min	max	min	max	min	max		
V _{IHdiff}	differential input high	+0.150	NOTE 3	+0.135	NOTE 3	+0.135	NOTE 3	+0.125	NOTE 3	+0.110	NOTE 3	V	1
V _{ILdiff}	differential input low	NOTE 3	-0.150	NOTE 3	-0.135	NOTE 3	-0.135	NOTE 3	-0.125	NOTE 3	-0.110	V	1

NOTE :

- Used to define a differential signal slew-rate.
- for CK_t - CK_c use V_{IH.CA}/V_{IL.CA}(AC) of ADD/CMD and V_{REFCA};
- These values are not defined; however, the differential signals CK_t - CK_c, need to be within the respective limits (V_{IH.CA}(DC) max, V_{IL.CA}(DC)min) for single-ended signals as well as the limitations for overshoot and undershoot.

Allowed time before ringback (tDVAC) for CK_t - CK_c

Slew Rate [V/ns]	tDVAC [ps] @ V _{IH/Ldiff} (AC) = 200mV		tDVAC [ps] @ V _{IH/Ldiff} (AC) = TBDmV	
	min	max	min	max
> 4.0	120	-	TBD	-
4.0	115	-	TBD	-
3.0	110	-	TBD	-
2.0	105	-	TBD	-
1.8	100	-	TBD	-
1.6	95	-	TBD	-
1.4	90	-	TBD	-
1.2	85	-	TBD	-
1.0	80	-	TBD	-
< 1.0	80	-	TBD	-

Single-ended requirements for differential signals

Each individual component of a differential signal (CK_t, CK_c) has also to comply with certain requirements for single-ended signals.

CK_t and CK_c have to approximately reach V_{SEH}min / V_{SEL}max (approximately equal to the ac-levels (V_{IH}.CA(AC) / V_{IL}.CA(AC)) for ADD/CMD signals) in every half-cycle.

Note that the applicable ac-levels for ADD/CMD might be different per speed-bin etc. E.g., if Different value than V_{IH}.CA(AC100)/V_{IL}.CA(AC100) is used for ADD/CMD signals, then these ac-levels apply also for the single-ended signals CK_t and CK_c

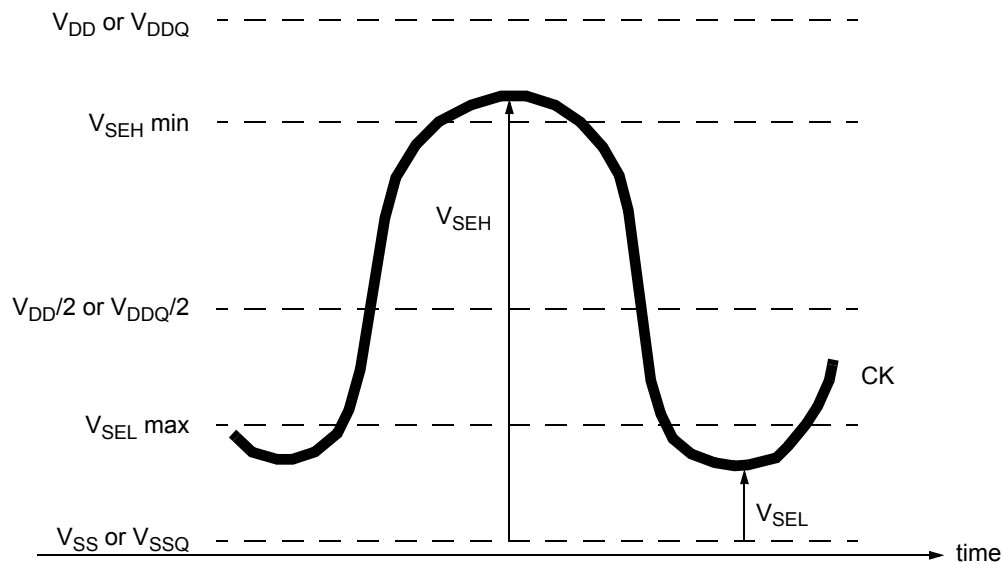

Single-ended requirement for differential signals

Note that, while ADD/CMD signal requirements are with respect to V_{refCA}, the single-ended components of differential signals have a requirement with respect to V_{DD} / 2; this is nominally the same. The transition of single-ended signals through the ac-levels is used to measure setup time. For single-ended components of differential signals the requirement to reach V_{SEL}max, V_{SEH}min has no bearing on timing, but adds a restriction on the common mode characteristics of these signals.

Single-ended levels for CK_t, CK_c

Symbol	Parameter	DDR4-1600/ 1866/2133		DDR4-2400		DDR4-2666		DDR4-2933		DDR4-3200		Unit	NOTE
		Min	Max	Min	Max	Min	Max	Min	Max	Min	Max		
V _{SEH}	Single-ended high-level for CK_t, CK_c	(VDD/2) +0.100	NOTE3	(VDD/2) +0.095	NOTE3	(VDD/2) +0.095	NOTE3	(VDD/2) +0.085	NOTE3	(VDD/2) +0.085	NOTE3	V	1, 2
V _{SEL}	Single-ended low-level for CK_t, CK_c	NOTE3	(VDD/2)- 0.100	NOTE3	(VDD/2)- 0.095	NOTE3	(VDD/2)- 0.095	NOTE3	(VDD/2)- 0.085	NOTE3	(VDD/2)- 0.085	V	1, 2

NOTE :

1. For CK_t - CK_c use V_{IH,CA}/V_{IL,CA}(AC) of ADD/CMD;
2. V_{IH}(AC)/V_{IL}(AC) for ADD/CMD is based on V_{REFCA};
3. These values are not defined, however the single-ended signals CK_t - CK_c need to be within the respective limits (V_{IH,CA}(DC) max, V_{IL,CA}(DC)min) for single-ended signals as well as the limitations for overshoot and undershoot.

Address and Control Overshoot and Undershoot specifications

AC overshoot/undershoot specification for Address, Command and Control pins

Parameter	Specification							Unit
	DDR4-1600	DDR4-1866	DDR4-2133	DDR4-2400	DDR4-2666	DDR4-2933	DDR4-3200	
Maximum peak amplitude above VDD Absolute Max allowed for overshoot area	0.06				0.06			V
Delta value between VDD Absolute Max and VDD Max allowed for overshoot area	VDD + 0.24				VDD + 0.24			V
Maximum peak amplitude allowed for undershoot area	0.30				0.30			V-ns
Maximum overshoot area per 1tCK Above Absolute Max	0.0083	0.0071	0.0062	0.0055	0.0055			V-ns
Maximum overshoot area per 1tCK Between Absolute Max	0.2550	0.2185	0.1914	0.1699	0.1699			V-ns
Maximum undershoot area per 1tCK Below VSS	0.2644	0.2265	0.1984	0.1762	0.1762			V-ns
(A0-A13,A17,BG0-BG1,BA0-BA1,ACT_n,RAS_n/A16,CAS_n/A15,WE_n/A14,CS_n,CKE,ODT,C2-C0)								

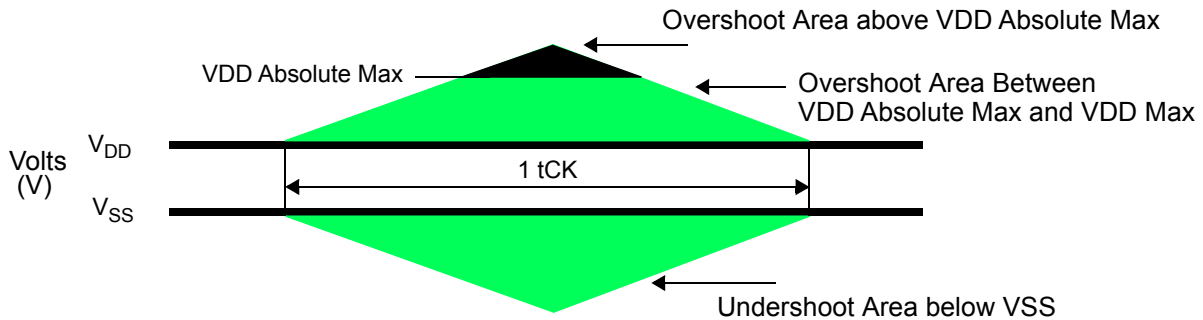

Address, Command and Control Overshoot and Undershoot Definition

Clock Overshoot and Undershoot Specifications

AC overshoot/undershoot specification for Clock

Parameter	Specification							Unit
	DDR4-1600	DDR4-1866	DDR4-2133	DDR4-2400	DDR4-2666	DDR4-2933	DDR4-3200	
Maximum peak amplitude above VDD Absolute Max allowed for overshoot area	0.06				0.06			V
Delta value between VDD Absolute Max and VDD Max allowed for overshoot area	VDD + 0.24				VDD + 0.24			V
Maximum peak amplitude allowed for undershoot area	0.30				0.30			V
Maximum overshoot area per 1UI Above Absolute Max	0.0038	0.0032	0.0028	0.0025	0.0025		V-ns	
Maximum overshoot area per 1UI Between Absolute Max	0.1125	0.0964	0.0844	0.0750	0.0750		V-ns	
Maximum undershoot area per 1UI Below VSS	0.1144	0.0980	0.0858	0.0762	0.0762		V-ns	
(CK_t, Ck_c)								

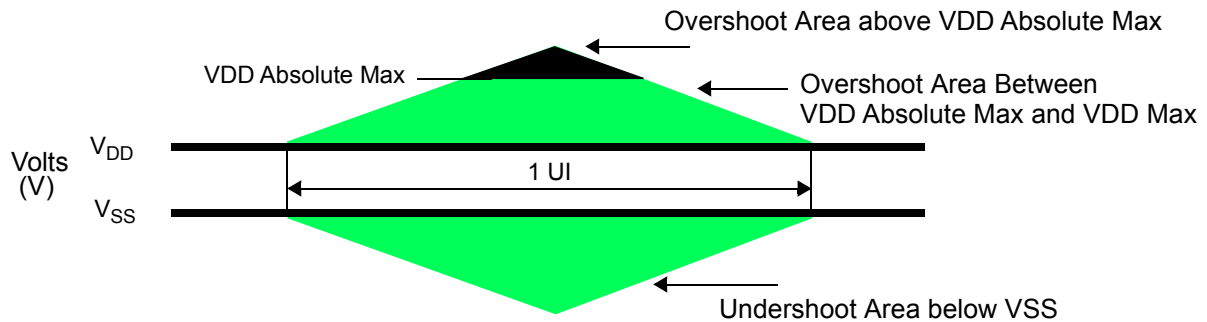

Clock Overshoot and Undershoot Definition

Data, Strobe and Mask Overshoot and Undershoot Specifications

AC overshoot/undershoot specification for Data, Strobe and Mask

Parameter	Specification							Unit
	DDR4-1600	DDR4-1866	DDR4-2133	DDR4-2400	DDR4-2666	DDR4-2933	DDR4-3200	
Maximum peak amplitude above Max absolute level of Vin,Vout	0.16	0.16	0.16	0.16	0.16			V
Overshoot area Between Max Absolute level of Vin, Vout and VDDQ Max	VDDQ + 0.24				VDDQ+0.24			V
Undershoot area Between Min absolute level of Vin,Vout and VDDQ Max	0.30	0.30	0.30	0.30	0.30			V
Maximum peak amplitude below Min absolute level of Vin,Vout	0.10	0.10	0.10	0.10	0.10			V
Maximum overshoot area per 1UI Above Max absolute level of Vin,Vout	0.0150	0.0129	0.0113	0.0100	0.0100			V-ns
Maximum overshoot area per 1UI Between Max absolute level of Vin,Vout and VDDQ Max	0.1050	0.0900	0.0788	0.0700	0.0700			V-ns
Maximum undershoot area per 1UI Between Min absolute level of Vin,Vout and VSSQ	0.1050	0.0900	0.0788	0.0700	0.0700			V-ns
Maximum undershoot area per 1UI Below Min absolute level of Vin,Vout	0.0150	0.0129	0.0113	0.0100	0.0100			V-ns

(DQ, DQS_t, DQS_c, DM_n, DBI_n, TDQS_t, TDQS_c)

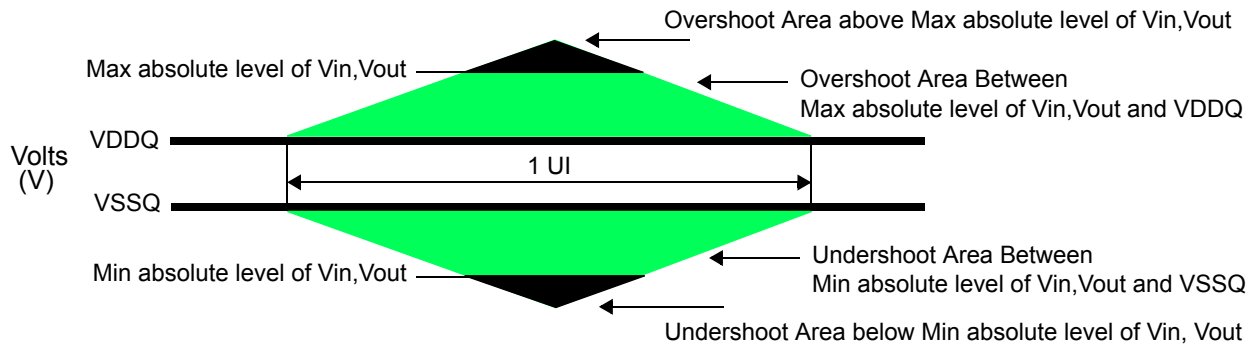

Data, Strobe and Mask Overshoot and Undershoot Definition

Slew Rate Definitions

Slew Rate Definitions for Differential Input Signals (CK)

Input slew rate for differential signals (CK_t, CK_c) are defined and measured as shown in Table and Figure below.

Differential Input Slew Rate Definition

Description			Defined by
	from	to	
Differential input slew rate for rising edge(CK _t - CK _c)	V _{ILdiffmax}	V _{IHdiffmin}	$[V_{IHdiffmin} - V_{ILdiffmax}] / \Delta TR_{diff}$
Differential input slew rate for falling edge(CK _t - CK _c)	V _{IHdiffmin}	V _{ILdiffmax}	$[V_{IHdiffmin} - V_{ILdiffmax}] / \Delta TF_{diff}$
NOTE: The differential signal (i.e.,CK _t - CK _c) must be linear between these thresholds.			

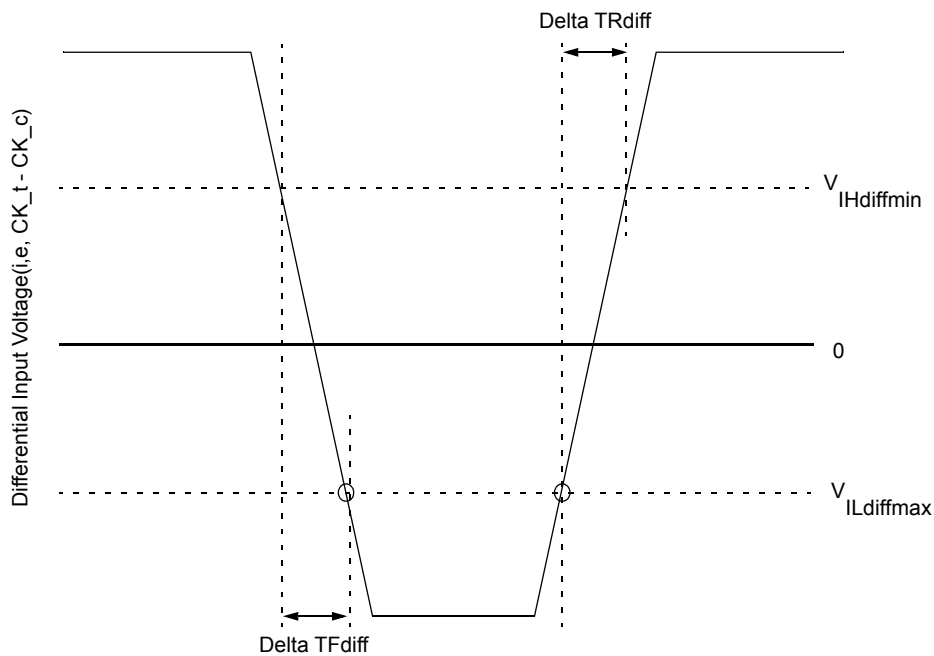

Differential Input Slew Rate Definition for CK_t, CK_c

Slew Rate Definition for Single-ended Input Signals (CMD/ADD)

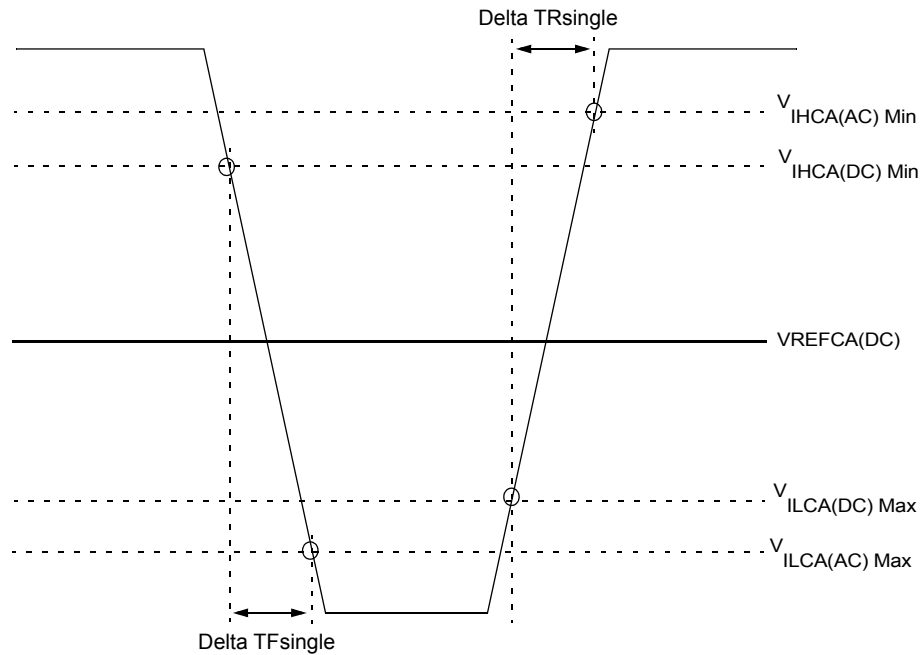

Single-ended Input Slew Rate definition for CMD and ADD

NOTE :

1. Single-ended input slew rate for rising edge = $\{ V_{IHCA(AC)Min} - V_{ILCA(DC)Max} \} / \Delta T_{Rsingle}$
2. Single-ended input slew rate for falling edge = $\{ V_{IHCA(DC)Min} - V_{ILCA(AC)Max} \} / \Delta T_{Fsingle}$
3. Single-ended signal rising edge from $V_{ILCA(DC)Max}$ to $V_{IHCA(DC)Min}$ must be monotonic slope.
4. Single-ended signal falling edge from $V_{IHCA(DC)Min}$ to $V_{ILCA(DC)Max}$ must be monotonic slope

Differential Input Cross Point Voltage

To guarantee tight setup and hold times as well as output skew parameters with respect to clock, each cross point voltage of differential input signals (CK_t, CK_c) must meet the requirements in Table. The differential input cross point voltage VIX is measured from the actual cross point of true and complement signals to the midlevel between of VDD and VSS.

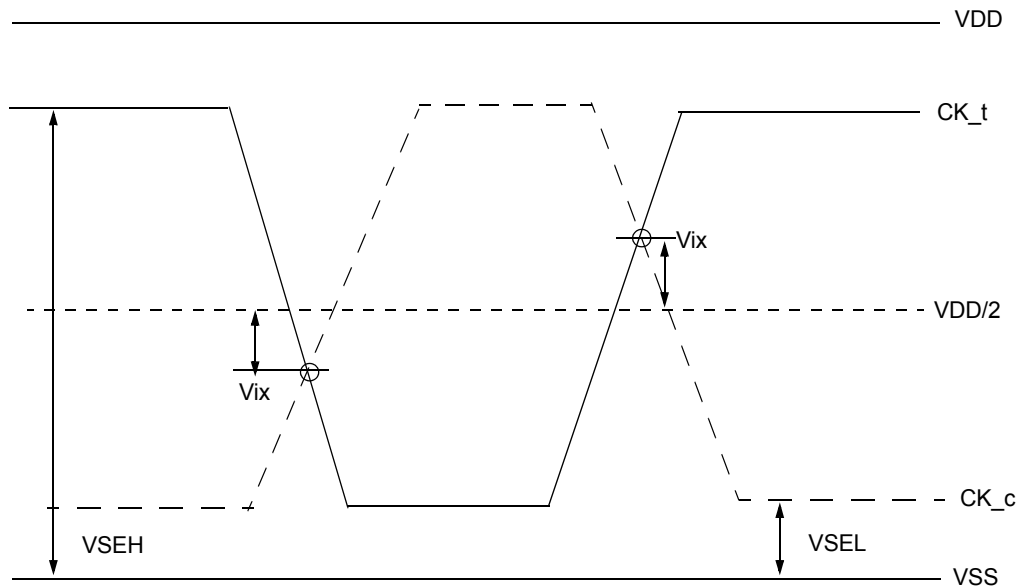

Vix Definition (CK)

Cross point voltage for differential input signals (CK)

Symbol	Parameter	DDR4-1600/1866/2133			
		min		max	
-	Area of VSEH, VSEL	$VSEL \leq VDD/2 - 145mV$	$VDD/2 - 145mV \leq VSEL \leq VDD/2 - 100mV$	$VDD/2 + 100mV \leq VSEL \leq VDD/2 + 145mV$	$VDD/2 + 145mV \leq VSEL$
VIX(CK)	Differential Input Cross Point Voltage relative to VDD/2 for CK_t, CK_c	-120mV	$-(VDD/2 - VSEL) + 25mV$	$(VSEH - VDD/2) - 25mV$	120mV

Symbol	Parameter	DDR4-2400/2666/2933/3200			
		min		max	
-	Area of VSEH, VSEL	VSEL =< VDD/2 - 145mV	VDD/2 - 145mV =< VSEL =< VDD/ 2 - 100mV	VDD/2 + 100mV =< VSEH =< VDD/2 + 145mV	VDD/2 + 145mV =< VSEH
VIX(CK)	Differential Input Cross Point Voltage relative to VDD/2 for CK_t, CK_c	-120mV	-(VDD/2 - VSEL) + 25mV	(VSEH - VDD/2) - 25mV	120mV

CMOS rail to rail Input Levels

CMOS rail to rail Input Levels for RESET_n

CMOS rail to rail Input Levels for RESET_n

Parameter	Symbol	Min	Max	Unit	NOTE
AC Input High Voltage	VIH(AC)_RESET	0.8*VDD	VDD	V	6
DC Input High Voltage	VIH(DC)_RESET	0.7*VDD	VDD	V	2
DC Input Low Voltage	VIL(DC)_RESET	VSS	0.3*VDD	V	1
AC Input Low Voltage	VIL(AC)_RESET	VSS	0.2*VDD	V	7
Rising time	TR_RESET	-	1.0	us	4
RESET pulse width	tPW_RESET	1.0	-	us	3,5

NOTE :

1. After RESET_n is registered LOW, RESET_n level shall be maintained below VIL(DC)_RESET during tPW_RESET, otherwise, SDRAM may not be reset.
2. Once RESET_n is registered HIGH, RESET_n level must be maintained above VIH(DC)_RESET, otherwise, SDRAM operation will not be guaranteed until it is reset asserting RESET_n signal LOW.
3. RESET is destructive to data contents.
4. No slope reversal(ringback) requirement during its level transition from Low to High.
5. This definition is applied only "Reset Procedure at Power Stable".
6. Overshoot might occur. It should be limited by the Absolute Maximum DC Ratings.
7. Undershoot might occur. It should be limited by Absolute Maximum DC Ratings

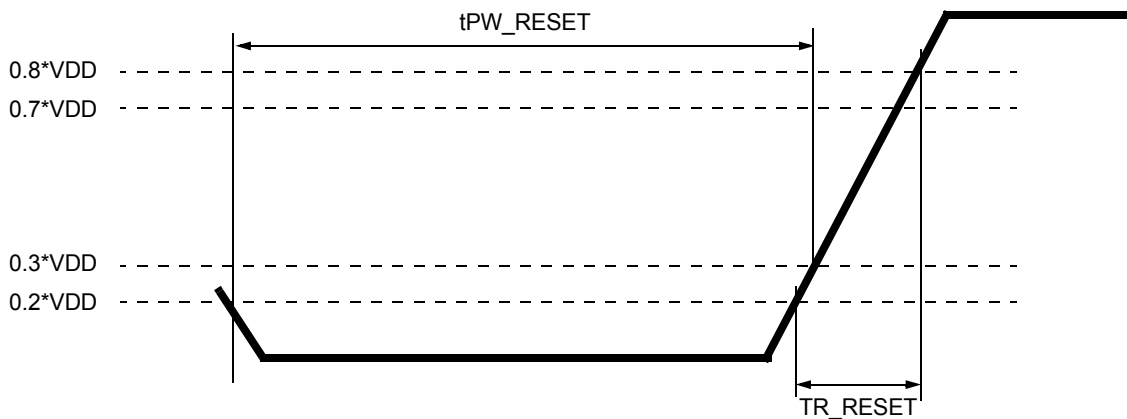

RESET_n Input Slew Rate Definition

AC and DC Logic Input Levels for DQS Signals

Differential signal definition

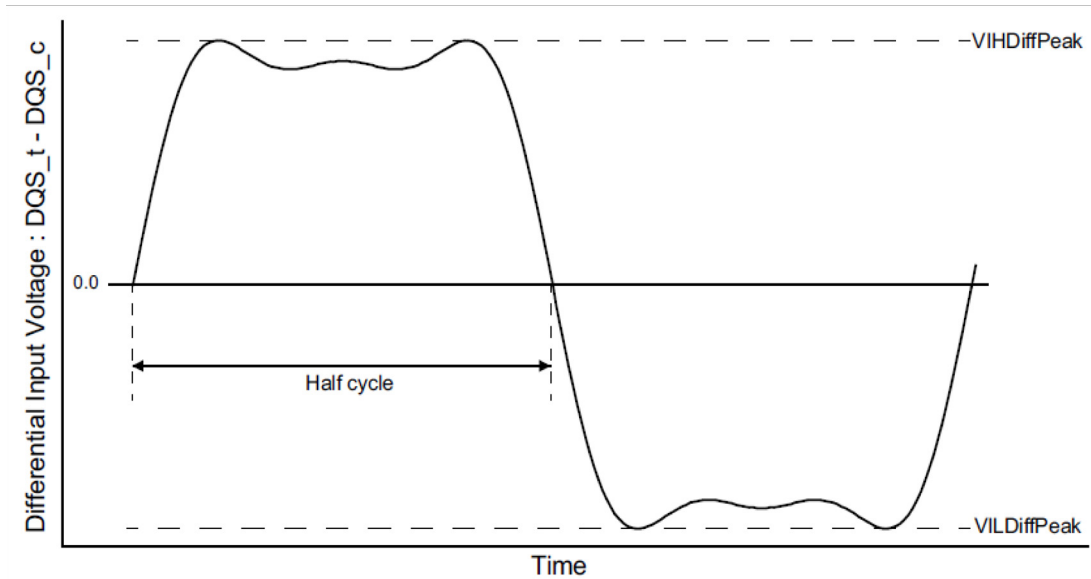

Definition of differential DQS Signal AC-swing Level

Differential swing requirements for DQS (DQS_t - DQS_c)

Differential AC and DC Input Levels for DQS

Symbol	Parameter	DDR4-1600,1866,2133		DDR4-2400		DDR4-2666,2933,3200		Unit	Note
		Min	Max	Min	Max	Min	Max		
VIHDiffPeak	VIH.DIFF.Peak Voltage	186	Note2	160	Note2	140	Note2	mV	1
VILDiffPeak	VIL.DIFF.Peak Voltage	Note2	-186	Note2	-160	Note2	-140	mV	1

NOTE :

1. Used to define a differential signal slew-rate.
2. These values are not defined; however, the differential signals DQS_t - DQS_c, need to be within the respective limits Overshoot, Undershoot Specification for single-ended signals.

Peak voltage calculation method

The peak voltage of Differential DQS signals are calculated in a following equation.

$$\mathbf{VIH.DIFF.Peak\ Voltage = Max(f(t))}$$

$$\mathbf{VIL.DIFF.Peak\ Voltage = Min(f(t))}$$

$$\mathbf{f(t) = VDQS_t - VDQS_c}$$

The Max(f(t)) or Min(f(t)) used to determine the midpoint which to reference the +/-35% window of the exempt non-monotonic signaling shall be the smallest peak voltage observed in all ui's.

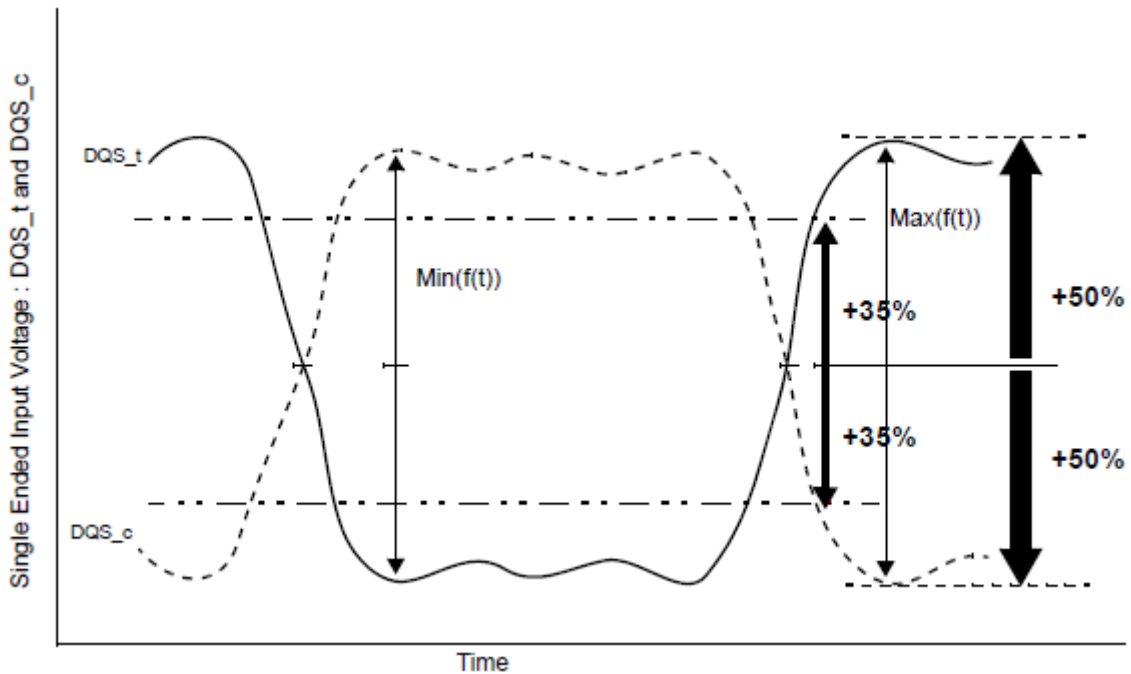

Definition of differential DQS Peak Voltage and range of exempt non-monotonic signaling

Differential Input Cross Point Voltage

To achieve tight RxMask input requirements as well as output skew parameters with respect to strobe, the cross point voltage of differential input signals (DQS_t, DQS_c) must meet the requirements in Table below. The differential input cross point voltage VIX_{DQS} (VIX_{DQS_FR} and VIX_{DQS_RF}) is measured from the actual cross point of DQS_t, DQS_c relative to the VDQSmid for the DQS_t and DQS_c signals.

VDQSmid is the midpoint of the minimum levels achieved by the transitioning DQS_t and DQS_c signals, and noted by VDQSmid. VDQSmid is the difference between the lowest horizontal tangent above VDQSmid of the transitioning DQS signals and the highest horizontal tangent below VDQSmid of the transitioning DQS signals.

A non-monotonic transitioning signal's ledge is exempt or not used in determination of a horizontal tangent provided the said ledge occurs within +/- 30% of the midpoint of either VID_{DIFF}.Peak Voltage (DQS_t rising) or VIL_{DIFF}.Peak Voltage (DQS_c rising), refer to Future Definition of differential DQS Peak Voltage and range of exempt non-monotonic signaling. A secondary horizontal tangent resulting from a ring-back transition is also exempt in determination of a horizontal tangent. That is, a falling transition's horizontal tangent is derived from its negative slope to zero slope transition (point A in Figure below) and a ring-back's horizontal tangent derived from its positive slope to zero slope transition (point B in Figure below) is not a valid horizontal tangent; and a rising transition's horizontal tangent is derived from its positive slope to zero slope transition (point C in Figure below) and a ring-back's horizontal tangent derived from its negative slope to zero slope transition (point D in Figure below) is not a valid horizontal tangent.

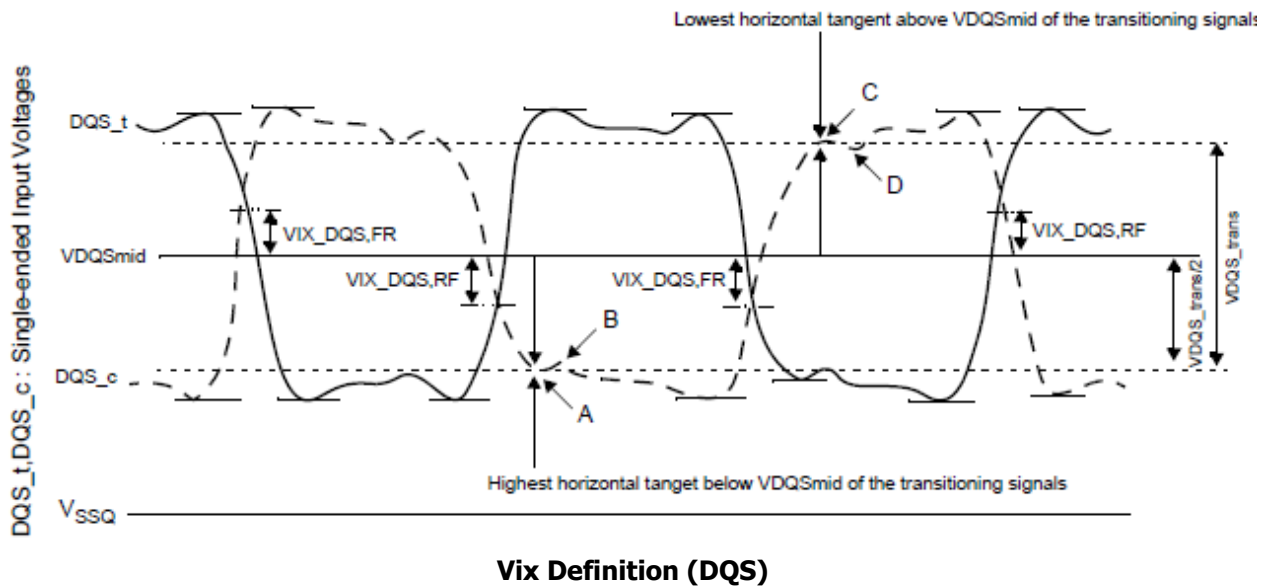

Cross point voltage for differential input signals

Symbol	Parameter	DDR4- 1600,1866,2133,2400		DDR4- 2666,2933,3200		Unit	Note
		Min	Max	Min	Max		
Vix_DOS_ ratio	DQS_t and DQS_c crossing relative to the midpoint of the DQS_t and DQS_c signal swings	-	25	-	25	%	1,2
VDQSmid_to_ Vcent	VDQSmid offset relative to Vcent_DQ(midpoint)	-	min(VIH-diff, 50)	-	min(VIH-diff, 50)	mV	3,4,5

NOTE :

1. Vix_DQS_Ratio is DQS VIX crossing (Vix_DQS_FR or Vix_DQS_RF) divided by VDQS_trans. VDQS_trans is the difference between the lowest horizontal tangent above VDQSmid of the transitioning DQS signals and the highest horizontal tangent below VDQSmid of the transitioning DQS signals.
2. VDQSmid will be similar to the VREFDQ internal setting value obtained during Vref Training if the DQS and DQS drivers and paths are matched.
3. The maximum limit shall not exceed the smaller of VIHdiff minimum limit or 50mV.
4. VIX measurements are only applicable for transitioning DQS_t and DQS_c signals when toggling data, preamble and high-z states are not applicable conditions.
5. The parameter VDQSmid is defined for simulation and ATE testing purposes, it is not expected to be tested in a system.

Differential Input Slew Rate Definition

Input slew rate for differential signals (DQS_t, DQS_c) are defined and measured as shown in Figure below.

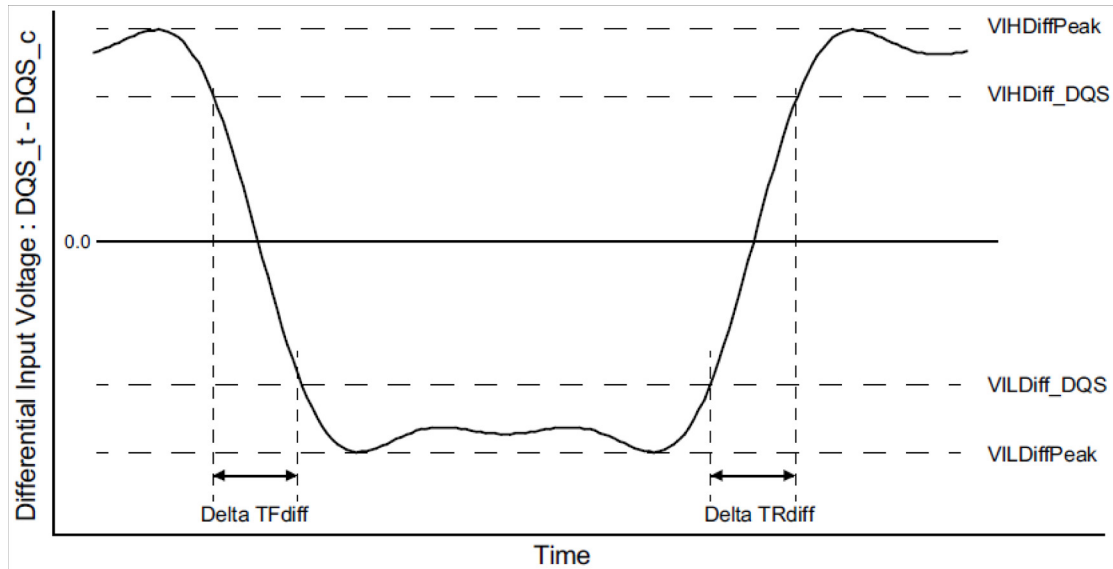

NOTE :

1. Differential signal rising edge from VILDiff_DQS to VIHDiff_DQS must be monotonic slope.
2. Differential signal falling edge from VIHDiff_DQS to VILDiff_DQS must be monotonic slope.

Differential Input Slew Rate Definition for DQS_t, DQS_c

Differential Input Slew Rate Definition for DQS_t, DQS_c

Description			Defined by
	From	To	
Differential input slew rate for rising edge(DQS _t - DQS _c)	VILDiff_DQS	VIHDiff_DQS	$ VILDiff_DQS - VIHDiff_DQS / \Delta TRdiff$
Differential input slew rate for falling edge(DQS _t - DQS _c)	VIHDiff_DQS	VILDiff_DQS	$ VILDiff_DQS - VIHDiff_DQS / \Delta TFdiff$

Differential Input Level for DQS_t, DQS_c

Symbol	Parameter	DDR4-1600,1866,2133		DDR4-2400		DDR4-2666		DDR4-2933		DDR4-3200		Unit	Note
		Min	Max	Min	Max	Min	Max	Min	Max	Min	Max		
VIHDiff_DQS	Differential Input High	136	-	130	-	130	-	115	-	110	-	mV	
VILDiff_DQS	Differential Input Low	-	-136	-	-130	-	-130	-	-115	-	-110	mV	

Differential Input Slew Rate for DQS_t, DQS_c

Symbol	Parameter	DDR4-1600,1866,2133		DDR4-2400		DDR4-2666		DDR4-2933		DDR4-3200		Unit	Note
		Min	Max	Min	Max	Min	Max	Min	Max	Min	Max		
SRIdiff	Differential Input Slew Rate	3	18	3	18	2.5	18	2.5	18	2.5	18	V/ns	

AC and DC output Measurement levels

Single-ended AC & DC Output Levels

Single-ended AC & DC output levels

Symbol	Parameter	DDR4-1600/1866/2133/ 2400/2666/2933/3200	Units	NOTE
$V_{OH(DC)}$	DC output high measurement level (for IV curve linearity)	$1.1 \times V_{DDQ}$	V	
$V_{OM(DC)}$	DC output mid measurement level (for IV curve linearity)	$0.8 \times V_{DDQ}$	V	
$V_{OL(DC)}$	DC output low measurement level (for IV curve linearity)	$0.5 \times V_{DDQ}$	V	
$V_{OH(AC)}$	AC output high measurement level (for output SR)	$(0.7 + 0.15) \times V_{DDQ}$	V	1
$V_{OL(AC)}$	AC output low measurement level (for output SR)	$(0.7 - 0.15) \times V_{DDQ}$	V	1

NOTE :

1. The swing of $\pm 0.15 \times V_{DDQ}$ is based on approximately 50% of the static single-ended output peak-to-peak swing with a driver impedance of $RZQ/7\Omega$ and an effective test load of 50Ω to $V_{TT} = V_{DDQ}$.

Differential AC & DC Output Levels

Differential AC & DC output levels

Symbol	Parameter	DDR4-1600/1866/ 2133/2400/2666/2933/ 3200	Units	NOTE
$V_{OHdiff(AC)}$	AC differential output high measurement level (for output SR)	$+0.3 \times V_{DDQ}$	V	1
$V_{OLdiff(AC)}$	AC differential output low measurement level (for output SR)	$-0.3 \times V_{DDQ}$	V	1

NOTE :

1. The swing of $\pm 0.3 \times V_{DDQ}$ is based on approximately 50% of the static differential output peak-to-peak swing with a driver impedance of $RZQ/7\Omega$ and an effective test load of 50Ω to $V_{TT} = V_{DDQ}$ at each of the differential outputs.

Single-ended Output Slew Rate

With the reference load for timing measurements, output slew rate for falling and rising edges is defined and measured between $V_{OL(AC)}$ and $V_{OH(AC)}$ for single ended signals as shown in Table and Figure below.

Single-ended output slew rate definition

Description	Measured		Defined by
	From	To	
Single ended output slew rate for rising edge	$V_{OL(AC)}$	$V_{OH(AC)}$	$[V_{OH(AC)} - V_{OL(AC)}] / \Delta TR_{se}$
Single ended output slew rate for falling edge	$V_{OH(AC)}$	$V_{OL(AC)}$	$[V_{OH(AC)} - V_{OL(AC)}] / \Delta TF_{se}$

NOTE :

1. Output slew rate is verified by design and characterization, and may not be subject to production test.

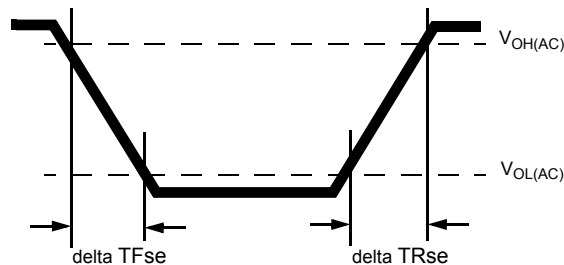

Single-ended Output Slew Rate Definition

Single-ended output slew rate

Parameter	Symbol	DDR4-1600		DDR4-1866		DDR4-2133		DDR4-2400		DDR4-2666		DDR4-2933		DDR4-3200		Units
		Min	Max	Min	Max	Min	Max	Min	Max	Min	Max	Min	Max	Min	Max	
Single ended output slew rate	SRQse	4	9	4	9	4	9	4	9	4	9	4	9	4	9	V/ns

Description: SR: Slew Rate

Q: Query Output (like in DQ, which stands for Data-in, Query-Output)

se: Single-ended Signals

For Ron = RZQ/7 setting

NOTE:

1. In two cases, a maximum slew rate of 12 V/ns applies for a single DQ signal within a byte lane.

-Case 1 is defined for a single DQ signal within a byte lane which is switching into a certain direction (either from high to low or low to high) while all remaining DQ signals in the same byte lane are static (i.e. they stay at either high or low).

-Case 2 is defined for a single DQ signal within a byte lane which is switching into a certain direction (either from high to low or low to high) while all remaining DQ signals in the same byte lane are switching into the opposite direction (i.e. from low to high or high to low respectively). For the remaining DQ signal switching into the opposite direction, the regular maximum limit of 9 V/ns applies

Differential Output Slew Rate

With the reference load for timing measurements, output slew rate for falling and rising edges is defined and measured between $V_{OLdiff}(AC)$ and $V_{OHdiff}(AC)$ for differential signals as shown in Table and Figure below.

Differential output slew rate definition

Description	Measured		Defined by
	From	To	
Differential output slew rate for rising edge	$V_{OLdiff}(AC)$	$V_{OHdiff}(AC)$	$[V_{OHdiff}(AC) - V_{OLdiff}(AC)] / \Delta TR_{diff}$
Differential output slew rate for falling edge	$V_{OHdiff}(AC)$	$V_{OLdiff}(AC)$	$[V_{OHdiff}(AC) - V_{OLdiff}(AC)] / \Delta TF_{diff}$

NOTE :

- Output slew rate is verified by design and characterization, and may not be subject to production test.

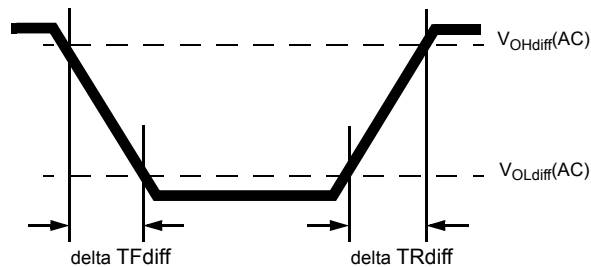

Differential Output Slew Rate Definition

Differential output slew rate

Parameter	Symbol	DDR4-1600		DDR4-1866		DDR4-2133		DDR4-2400		DDR4-2666		DDR4-2933		DDR4-3200		Units
		Min	Max	Min	Max	Min	Max	Min	Max	Min	Max	Min	Max			
Differential output slew rate	SRQdiff	8	18	8	18	8	18	8	18	8	18	8	18	8	18	V/ns

Description:

SR: Slew Rate

Q: Query Output (like in DQ, which stands for Data-in, Query-Output)

diff: Differential Signals

For Ron = RZQ/7 setting

Single-ended AC & DC Output Levels of Connectivity Test Mode

Following output parameters will be applied for DDR4 SDRAM Output Signal during Connectivity Test Mode.

Single-ended AC & DC output levels of Connectivity Test Mode

Symbol	Parameter	DDR4-1600/1866/2133/ 2400/2666/2933/3200	Unit	Note
$V_{OH}(DC)$	DC output high measurement level (for IV curve linearity)	$1.1 \times V_{DDQ}$	V	
$V_{OM}(DC)$	DC output mid measurement level (for IV curve linearity)	$0.8 \times V_{DDQ}$	V	
$V_{OL}(DC)$	DC output low measurement level (for IV curve linearity)	$0.5 \times V_{DDQ}$	V	
$V_{OB}(DC)$	DC output below measurement level (for IV curve linearity)	$0.2 \times V_{DDQ}$	V	
$V_{OH}(AC)$	AC output high measurement level (for output SR)	$V_{TT} + (0.1 \times V_{DDQ})$	V	1
$V_{OL}(AC)$	AC output below measurement level (for output SR)	$V_{TT} - (0.1 \times V_{DDQ})$	V	1

NOTE :

1. The effective test load is 50Ω terminated by $V_{TT} = 0.5 \times V_{DDQ}$.

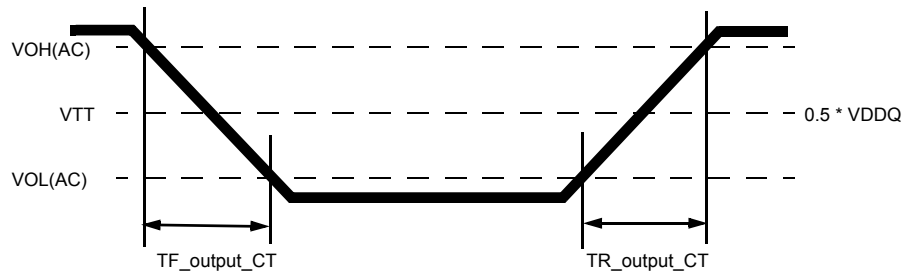

Differential Output Slew Rate Definition of Connectivity Test Mode

Single-ended output slew rate of Connectivity Test Mode

Parameter	Symbol	DDR4-1600/1866/2133/2400/2666/2933/3200		Unit	Note
		Min	Max		
Output signal Falling time	TF_{output_CT}	-	10	ns/V	
Output signal Rising time	TR_{output_CT}	-	10	ns/V	

Standard Speed Bins

DDR4-1600 Speed Bins and Operations

Speed Bin			DDR4-1600K		Unit	NOTE	
CL-nRCD-nRP			11-11-11				
Parameter	Symbol		min	max			
Internal read command to first data	tAA		13.75 ¹⁴ (13.50) ^{5,12}	18.00	ns	12	
Internal read command to first data with read DBI enabled	tAA_DBI		tAA(min) + 2nCK	tAA(max) + 2nCK	ns	12	
ACT to internal read or write delay time	tRCD		13.75 (13.50) ^{5,12}	-	ns	12	
PRE command period	tRP		13.75 (13.50) ^{5,12}	-	ns	12	
ACT to PRE command period	tRAS		35	9 x tREFI	ns	12	
ACT to ACT or REF command period	tRC		48.75 (48.50) ^{5,12}	-	ns	12	
	Normal	Read DBI					
CWL = 9	CL = 9	CL = 11 (Optional) 5	tCK(AVG)	1.5	1.6	ns	1,2,3,4, 11,14
	CL = 10	CL = 12	tCK(AVG)	Reserved		ns	1,2,3,4, 11
CWL = 9,11	CL = 10	CL = 12	tCK(AVG)	Reserved		ns	1,2,3,4
	CL = 11	CL = 13	tCK(AVG)	1.25	<1.5	ns	1,2,3,4
	CL = 12	CL = 14	tCK(AVG)	1.25	<1.5	ns	1,2,3
Supported CL Settings				(9),11,12		nCK	13,14
Supported CL Settings with read DBI				(11),13,14		nCK	13
Supported CWL Settings				9,11		nCK	

DDR4-1866 Speed Bins and Operations

Speed Bin			DDR4-1866M		Unit	NOTE	
CL-nRCD-nRP			13-13-13				
Parameter	Symbol		min	max			
Internal read command to first data	tAA		13.92 ¹⁴ (13.50) ^{5,12}	18.00	ns	12	
Internal read command to first data with read DBI enabled	tAA_DBI		tAA(min) + 2nCK	tAA(max) + 2nCK	ns	12	
ACT to internal read or write delay time	tRCD		13.92 (13.50) ^{5,12}	-	ns	12	
PRE command period	tRP		13.92 (13.50) ^{5,12}	-	ns	12	
ACT to PRE command period	tRAS		34	9 x tREFI	ns	12	
ACT to ACT or REF command period	tRC		47.92 (47.50) ^{5,12}	-	ns	12	
	Normal	Read DBI					
CWL = 9	CL = 9	CL = 11 (Optional) ⁵	tCK(AVG)	1.5	1.6	ns	1,2,3,4, 11,14
	CL = 10	CL = 12	tCK(AVG)	Reserved		ns	1,2,3,4, 11
CWL = 9,11	CL = 10	CL = 12	tCK(AVG)	Reserved		ns	4
	CL = 11	CL = 13	tCK(AVG)	1.25	<1.5	ns	1,2,3,4, 6
	CL = 12	CL = 14	tCK(AVG)	1.25	<1.5	ns	1,2,3,6
CWL = 10,12	CL = 12	CL = 14	tCK(AVG)	Reserved		ns	1,2,3,4
	CL = 13	CL = 15	tCK(AVG)	1.071	<1.25	ns	1,2,3,4
	CL = 14	CL = 16	tCK(AVG)	1.071	<1.25	ns	1,2,3
Supported CL Settings			9,11,12,13,14		nCK	13,14	
Supported CL Settings with read DBI			11,13,14 15,16		nCK	13	
Supported CWL Settings			9,10,11,12		nCK		

DDR4-2133 Speed Bins and Operations

Speed Bin			DDR4-2133P		Unit	NOTE
CL-nRCD-nRP			15-15-15			
Parameter	Symbol		min	max		
Internal read command to first data	tAA		14.06 ¹⁴ (13.50) ^{5,12}	18.00	ns	12
Internal read command to first data with read DBI enabled	tAA_DBI		tAA(min) + 3nCK	tAA(max) + 3nCK	ns	12
ACT to internal read or write delay time	tRCD		14.06 (13.50) ^{5,12}	-	ns	12
PRE command period	tRP		14.06 (13.50) ^{5,12}	-	ns	12
ACT to PRE command period	tRAS		33	9 x tREFI	ns	12
ACT to ACT or REF command period	tRC		47.06 (46.50) ^{5,12}	-	ns	12
	Normal	Read DBI				
CWL = 9	CL = 9	CL = 11	tCK(AVG)	1.5	1.6	ns 1,2,3,4, 11,14
	CL = 10	CL = 12	tCK(AVG)	Reserved		ns 1,2,3,11
CWL = 9,11	CL = 11	CL = 13	tCK(AVG)	1.25	<1.5	ns 1,2,3,4, 7
	CL = 12	CL = 14	tCK(AVG)	1.25	<1.5	ns 1,2,3,7
CWL = 10,12	CL = 13	CL = 15	tCK(AVG)	1.071	<1.25	ns 1,2,3,4, 7
	CL = 14	CL = 16	tCK(AVG)	1.071	<1.25	ns 1,2,3,7
CWL = 11,14	CL = 14	CL = 17	tCK(AVG)	Reserved		ns 1,2,3,4
	CL = 15	CL = 18	tCK(AVG)	0.937	<1.071	ns 1,2,3,4
	CL = 16	CL = 19	tCK(AVG)	0.937	<1.071	ns 1,2,3
Supported CL Settings			(9),(11),12,(13),14,15,16		nCK	13,14
Supported CL Settings with read DBI			(11),(13),14,(15),16,18,19		nCK	
Supported CWL Settings			9,10,11,12,14		ns	12

DDR4-2400 Speed Bins and Operations

Speed Bin			DDR4-2400T		Unit	NOTE
CL-nRCD-nRP			17-17-17			
Parameter	Symbol		min	max		
Internal read command to first data	tAA		14.16 (13.75) ^{5,12}	18.00	ns	12
Internal read command to first data with read DBI enabled	tAA_DBI		tAA(min) + 3nCK	tAA(max) + 3nCK	ns	12
ACT to internal read or write delay time	tRCD		14.16 (13.75) ^{5,12}	-	ns	12
PRE command period	tRP		14.16 (13.75) ^{5,12}	-	ns	12
ACT to PRE command period	tRAS		32	9 x tREFI	ns	12
ACT to ACT or REF command period	tRC		46.16 (45.75) ^{5,12}	-	ns	12
	Normal	Read DBI				
CWL = 9	CL = 9	CL = 11 (Optional) ⁵	tCK(AVG)	Reserved	ns	1,2,3,4,11
	CL = 10	CL = 12		1.5 1.6	ns	1,2,3,4,11
CWL = 9,11	CL = 10	CL = 12	tCK(AVG)	Reserved	ns	4
	CL = 11	CL = 13	tCK(AVG)	1.25 <1.5	ns	1,2,3,4,8
	CL = 12	CL = 14	tCK(AVG)	1.25 <1.5	ns	1,2,3,8
CWL = 10,12	CL = 12	CL = 14	tCK(AVG)	Reserved	ns	4
	CL = 13	CL = 15	tCK(AVG)	1.071 <1.25	ns	1,2,3,4,8
	CL = 14	CL = 16	tCK(AVG)	1.071 <1.25	ns	1,2,3,8
CWL = 11,14	CL = 14	CL = 17	tCK(AVG)	Reserved	ns	4
	CL = 15	CL = 18	tCK(AVG)	0.937 <1.071	ns	1,2,3,4,8
	CL = 16	CL = 19	tCK(AVG)	0.937 <1.071	ns	1,2,3,8
CWL = 12,16	CL = 15	CL = 18	tCK(AVG)	Reserved	ns	1,2,3,4
	CL = 16	CL = 19	tCK(AVG)	Reserved	ns	1,2,3,4
	CL = 17	CL = 20	tCK(AVG)	0.833 <0.937		
	CL = 18	CL = 21	tCK(AVG)	0.833 <0.937	ns	1,2,3
Supported CL Settings			10,11,12,13,14,15,16,17,18		nCK	13
Supported CL Settings with read DBI			12,13,14,15,16,18,19,20,21		nCK	
Supported CWL Settings			9,10,11,12,14,16		nCK	

DDR4-2666 Speed Bins and Operations

Speed Bin			DDR4-2666V		Unit	NOTE	
CL-nRCD-nRP			19-19-19				
Parameter	Symbol		min	max			
Internal read command to first data	tAA		14.25 ¹⁴ (13.75) ^{5,12}	18.00	ns	12	
Internal read command to first data with read DBI enabled	tAA_DBI		tAA(min) + 3nCK	tAA(max) + 3nCK	ns	12	
ACT to internal read or write delay time	tRCD		14.25 (13.75) ^{5,12}	-	ns	12	
PRE command period	tRP		14.25 (13.75) ^{5,12}	-	ns	12	
ACT to PRE command period	tRAS		32	9 x tREFI	ns	12	
ACT to ACT or REF command period	tRC		46.25 (45.75) ^{5,12}	-	ns	12	
	Normal	Read DBI					
CWL = 9	CL = 9	CL = 11	tCK(AVG)	Reserved	ns	1,2,3,4,11	
	CL = 10	CL = 12	tCK(AVG)	1.5	1.6	ns	1,2,3,11
CWL = 9,11	CL = 10	CL = 12	tCK(AVG)	Reserved	ns	4	
	CL = 11	CL = 13	tCK(AVG)	1.25	<1.5	ns	1,2,3,4,9
	CL = 12	CL = 14	tCK(AVG)	1.25	<1.5	ns	1,2,3,9
CWL = 10,12	CL = 12	CL = 14	tCK(AVG)	Reserved	ns	4	
	CL = 13	CL = 15	tCK(AVG)	1.071	<1.25	ns	1,2,3,4,9
	CL = 14	CL = 16	tCK(AVG)	1.071	<1.25	ns	1,2,3,9
CWL = 11,14	CL = 14	CL = 17	tCK(AVG)	Reserved	ns	4	
	CL = 15	CL = 18	tCK(AVG)	0.937	<1.071	ns	1,2,3,4,9
	CL = 16	CL = 19	tCK(AVG)	0.937	<1.071	ns	1,2,3,9
CWL = 12,16	CL = 15	CL = 18	tCK(AVG)	Reserved	ns	4	
	CL = 16	CL = 19	tCK(AVG)	Reserved	ns	1,2,3,4,9	
	CL = 17	CL = 20	tCK(AVG)	0.833	<0.937	ns	1,2,3,4,9
	CL = 18	CL = 21	tCK(AVG)	0.833	<0.937	ns	1,2,3
CWL = 14,18	CL = 17	CL = 20	tCK(AVG)	Reserved	ns	1,2,3,4	
	CL = 18	CL = 21	tCK(AVG)	Reserved	ns	1,2,3,4	
	CL = 19	CL = 22	tCK(AVG)	0.75	<0.833	ns	1,2,3,4
	CL = 20	CL = 23	tCK(AVG)	0.75	<0.833	ns	1,2,3
Supported CL Settings			10,(11),12,(13),14,(15),16,(17),18,19,20		nCK	13	
Supported CL Settings with read DBI			12,(13),14,(15),17,(18),19,(20),21,22,23		nCK		
Supported CWL Settings			9,10,11,12,14,16,18		nCK		

DDR4-2933 Speed Bins and Operations

Speed Bin			DDR4-2933Y		Unit	NOTE	
CL-nRCD-nRP			21-21-21				
Parameter	Symbol		min	max			
Internal read command to first data	tAA		14.32 ¹⁴ (13.75) ^{5,12}	18.00	ns	12	
Internal read command to first data with read DBI enabled	tAA_DBI		tAA(min) + 4nCK	tAA(max) + 4nCK	ns	12	
ACT to internal read or write delay time	tRCD		14.32 (13.75) ^{5,12}	-	ns	12	
PRE command period	tRP		14.32 (13.75) ^{5,12}	-	ns	12	
ACT to PRE command period	tRAS		32	9 x tREFI	ns	12	
ACT to ACT or REF command period	tRC		46.32 (45.75) ^{5,12}	-	ns	12	
	Normal	Read DBI					
CWL = 9	CL = 9	CL = 11	tCK(AVG)	Reserved		ns	1,2,3,4,11
	CL = 10	CL = 12	tCK(AVG)	1.5	1.6	ns	1,2,3,11
CWL = 9,11	CL = 10	CL = 12	tCK(AVG)	Reserved		ns	1,2,3,4
	CL = 11	CL = 13	tCK(AVG)	1.25	<1.5	ns	1,2,3,4,13
	CL = 12	CL = 14	tCK(AVG)	1.25	<1.5	ns	1,2,3,15
CWL = 10,12	CL = 12	CL = 14	tCK(AVG)	Reserved		ns	1,2,3,4
	CL = 13	CL = 15	tCK(AVG)	1.071	<1.25	ns	1,2,3,4,15
	CL = 14	CL = 16	tCK(AVG)	1.071	<1.25	ns	1,2,3,15
CWL = 11,14	CL = 14	CL = 17	tCK(AVG)	Reserved		ns	1,2,3,4
	CL = 15	CL = 18	tCK(AVG)	0.937	<1.071	ns	1,2,3,4,15
	CL = 16	CL = 19	tCK(AVG)	0.937	<1.071	ns	1,2,3,15
CWL = 12,16	CL = 15	CL = 18	tCK(AVG)	Reserved		ns	1,2,3,4
	CL = 16	CL = 19	tCK(AVG)	Reserved		ns	1,2,3,4,15
	CL = 17	CL = 20	tCK(AVG)	0.833	0.937	ns	1,2,3,4,15
	CL = 18	CL = 21	tCK(AVG)	0.833	0.937	ns	1,2,3,15
CWL = 14,18	CL = 17	CL = 20	tCK(AVG)	Reserved		ns	1,2,3,4
	CL = 18	CL = 21	tCK(AVG)	Reserved		ns	1,2,3,4,15
	CL = 19	CL = 22	tCK(AVG)	0.75	<0.833	ns	1,2,3,4,15
	CL = 20	CL = 23	tCK(AVG)	0.75	<0.833	ns	1,2,3,15
CWL = 16,20	CL = 19	CL = 23	tCK(AVG)	Reserved		ns	1,2,3,4
	CL = 20	CL = 24	tCK(AVG)	Reserved		ns	1,2,3,4
	CL = 21	CL = 26	tCK(AVG)	0.682	<0.75	ns	1,2,3,4
	CL = 22	CL = 26	tCK(AVG)	0.682	<0.75	ns	1,2,3
Supported CL Settings			10,(11),12,(13),14,(15),16,(17),18,(19),20,21,22		nCK	13	
Supported CL Settings with read DBI			12,(13),14,(15),16,(18),19,(20),21,(22),23,25,26		nCK	13	
Supported CWL Settings			9,10,11,12,14,15,16,18,20		nCK		

DDR4-3200 Speed Bins and Operations

Speed Bin			DDR4-3200AA		Unit	NOTE	
CL-nRCD-nRP			22-22-22				
Parameter	Symbol		min	max			
Internal read command to first data	tAA		13.75	18.00	ns	12	
Internal read command to first data with read DBI enabled	tAA_DBI		tAA(min) + 4nCK	tAA(max) + 4nCK	ns	12	
ACT to internal read or write delay time	tRCD		13.75	-	ns	12	
PRE command period	tRP		13.75	-	ns	12	
ACT to PRE command period	tRAS		32	9 x tREFI	ns	12	
ACT to ACT or REF command period	tRC		45.75	-	ns	12	
	Normal	Read DBI					
CWL = 9	CL = 9	CL = 11	tCK(AVG)	Reserved	ns	1,2,3,4,11	
	CL = 10	CL = 12	tCK(AVG)	Reserved	ns	1,2,3,4,11	
CWL = 9,11	CL = 10	CL = 12	tCK(AVG)	Reserved	ns	1,2,3,4	
	CL = 11	CL = 13	tCK(AVG)	1.25	<1.5	ns	1,2,3,4,10
	CL = 12	CL = 14	tCK(AVG)	1.25	<1.5	ns	1,2,3,10
CWL = 10,12	CL = 12	CL = 14	tCK(AVG)	Reserved	ns	1,2,3,4	
	CL = 13	CL = 15	tCK(AVG)	1.071	<1.25	ns	1,2,3,4,10
	CL = 14	CL = 16	tCK(AVG)	1.071	<1.25	ns	1,2,3,10
CWL = 11,14	CL = 14	CL = 17	tCK(AVG)	Reserved	ns	1,2,3,4	
	CL = 15	CL = 18	tCK(AVG)	0.937	<1.071	ns	1,2,3,4,10
	CL = 16	CL = 19	tCK(AVG)	0.937	<1.071	ns	1,2,3,10
CWL = 12,16	CL = 15	CL = 18	tCK(AVG)	Reserved	ns	1,2,3,4	
	CL = 16	CL = 19	tCK(AVG)	Reserved	ns	1,2,3,4,10	
	CL = 17	CL = 20	tCK(AVG)	0.833	<0.937	ns	1,2,3,4,10
	CL = 18	CL = 21	tCK(AVG)	0.833	<0.937	ns	1,2,3,10
CWL = 14,18	CL = 17	CL = 20	tCK(AVG)	Reserved	ns	1,2,3,4	
	CL = 18	CL = 21	tCK(AVG)	Reserved	ns	1,2,3,4,10	
	CL = 19	CL = 22	tCK(AVG)	0.75	<0.833	ns	1,2,3,4,10
	CL = 20	CL = 23	tCK(AVG)	0.75	<0.833	ns	1,2,3,10
CWL = 16,20	CL = 20	CL = 24	tCK(AVG)	Reserved	ns	1,2,3,4	
	CL = 22	CL = 26	tCK(AVG)	0.625	<0.75	ns	1,2,3,4
	CL = 24	CL = 28	tCK(AVG)	0.625	<0.75	ns	1,2,3
Supported CL Settings			10,11,12,13,14,15, 16,17,18,19,20,22, 24		nCK	13	
Supported CL Settings with read DBI			12,13,14,15,16,18, 19,20,21,22,23,24, 26, 28		nCK		
Supported CWL Settings			9,10,11,12,14,16, 18,20		nCK		

Speed Bin Table Note

Absolute Specification

- VDDQ = VDD = 1.20V +/- 0.06 V
- VPP = 2.5V +0.25/-0.125 V
- The values defined with above-mentioned table are DLL ON case.
- DDR4-1600, 1866, 2133, 2400, 2933 and 3200 Speed Bin Tables are valid only when Geardown Mode is disabled.

1. The CL setting and CWL setting result in tCK(avg).MIN and tCK(avg).MAX requirements. When making a selection of tCK(avg), both need to be fulfilled: Requirements from CL setting as well as requirements from CWL setting.
2. tCK(avg).MIN limits: Since CAS Latency is not purely analog - data and strobe output are synchronized by the DLL - all possible intermediate frequencies may not be guaranteed. CL in clock cycle is calculated from tAA following rounding algorithm defined in Section 13.5.
3. tCK(avg).MAX limits: Calculate $tCK(avg) = tAA.MAX / CL\ SELECTED$ and round the resulting tCK(avg) down to the next valid speed bin (i.e. 1.5ns or 1.25ns or 1.071 ns or 0.937 ns or 0.833 ns). This result is tCK(avg).MAX corresponding to CL SELECTED.
4. 'Reserved' settings are not allowed. User must program a different value.
5. 'Optional' settings allow certain devices in the industry to support this setting, however, it is not a mandatory feature. Refer to supplier's data sheet and/or the DIMM SPD information if and how this setting is supported.
6. Any DDR4-1866 speed bin also supports functional operation at lower frequencies as shown in the table which are not subject to Production Tests but verified by Design/Characterization.
7. Any DDR4-2133 speed bin also supports functional operation at lower frequencies as shown in the table which are not subject to Production Tests but verified by Design/Characterization.
8. Any DDR4-2400 speed bin also supports functional operation at lower frequencies as shown in the table which are not subject to Production Tests but verified by Design/Characterization.
9. Any DDR4-2666 speed bin also supports functional operation at lower frequencies as shown in the table which are not subject to Production Tests but verified by Design/Characterization.
10. Any DDR4-3200 speed bin also supports functional operation at lower frequencies as shown in the table which are not subject to Production Tests but verified by Design/Characterization.
11. DDR4-1600 AC timing apply if DRAM operates at lower than 1600 MT/s data rate.
12. DDR4-2400,2666,2933 and 3200Mbps speed bin support CL=10 if DRAM operate at 1333MT/s data rate.
13. Parameters apply from tCK(avg)min to tCK(avg)max at all standard JEDEC clock period values as stated in the Speed Bin Tables.
14. CL number in parentheses, it means that these numbers are optional.
15. DDR4 SDRAM supports CL=9 as long as a system meets tAA(min).
16. Each speed bin lists the timing requirements that need to be supported in order for a given DRAM to be JEDEC compliant. JEDEC compliance does not require support for all speed bins within a given speed. JEDEC compliance requires meeting the parameters for a least one of the listed speed bins.

IDD and IDDQ Specification Parameters and Test Conditions

IDD, IPP and IDDQ Measurement Conditions

In this chapter, IDD, IPP and IDDQ measurement conditions such as test load and patterns are defined. Figure shows the setup and test load for IDD, IPP and IDDQ measurements.

- IDD currents (such as IDD0, IDD0A, IDD1, IDD1A, IDD2N, IDD2NA, IDD2NL, IDD2NT, IDD2P, IDD2Q, IDD3N, IDD3NA, IDD3P, IDD4R, IDD4RA, IDD4W, IDD4WA, IDD5B, IDD5F2, IDD5F4, IDD6N, IDD6E, IDD6R, IDD6A, IDD7 and IDD8) are measured as time-averaged currents with all VDD balls of the DDR4 SDRAM under test tied together. Any IPP or IDDQ current is not included in IDD currents.
- IPP currents have the same definition as IDD except that the current on the VPP supply is measured.
- IDDQ currents (such as IDDQ2NT and IDDQ4R) are measured as time-averaged currents with all VDDQ balls of the DDR4 SDRAM under test tied together. Any IDD current is not included in IDDQ currents.

Attention: IDDQ values cannot be directly used to calculate IO power of the DDR4 SDRAM. They can be used to support correlation of simulated IO power to actual IO power as outlined in Figure 2. In DRAM module application, IDDQ cannot be measured separately since VDD and VDDQ are using one merged-power layer in Module PCB.

For IDD, IPP and IDDQ measurements, the following definitions apply:

- "0" and "LOW" is defined as $V_{IN} \leq V_{ILAC}(\max)$.
- "1" and "HIGH" is defined as $V_{IN} \geq V_{IHAC}(\min)$.
- "MID-LEVEL" is defined as inputs are $V_{REF} = V_{DD} / 2$.
- Timings used for IDD, IPP and IDDQ Measurement-Loop Patterns are provided in Table 1.
- Basic IDD, IPP and IDDQ Measurement Conditions are described in Table 2.
- Detailed IDD, IPP and IDDQ Measurement-Loop Patterns are described in Table 3 through Table 11.
- IDD Measurements are done after properly initializing the DDR4 SDRAM. This includes but is not limited to setting
 - RON = RZQ/7 (34 Ohm in MR1);
 - RTT_NOM = RZQ/6 (40 Ohm in MR1);
 - RTT_WR = RZQ/2 (120 Ohm in MR2);
 - RTT_PARK = Disable;
 - Qoff = 0_B (Output Buffer enabled) in MR1;
 - TDQS_t disabled in MR1;
 - CRC disabled in MR2;
 - CA parity feature disabled in MR5;
 - Gear down mode disabled in MR3
 - Read/Write DBI disabled in MR5;
 - DM disabled in MR5
- Attention: The IDD, IPP and IDDQ Measurement-Loop Patterns need to be executed at least one time before actual IDD or IDDQ measurement is started.
- Define $D = \{CS_n, ACT_n, RAS_n, CAS_n, WE_n\} := \{HIGH, LOW, LOW, LOW, LOW\}$; apply BG/BA changes when directed.
- Define $D\# = \{CS_n, ACT_n, RAS_n, CAS_n, WE_n\} := \{HIGH, HIGH, HIGH, HIGH, HIGH\}$; apply invert of BG/BA changes when directed above.

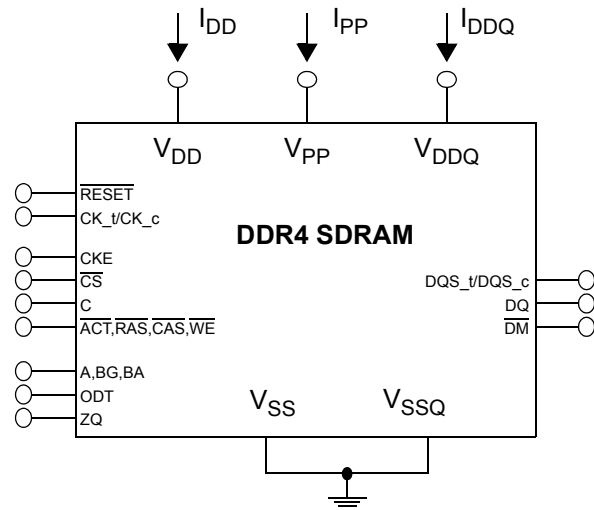

NOTE:

1. DIMM level Output test load condition may be different from above

Figure 1 - Measurement Setup and Test Load for IDD, IPP and IDDQ Measurements

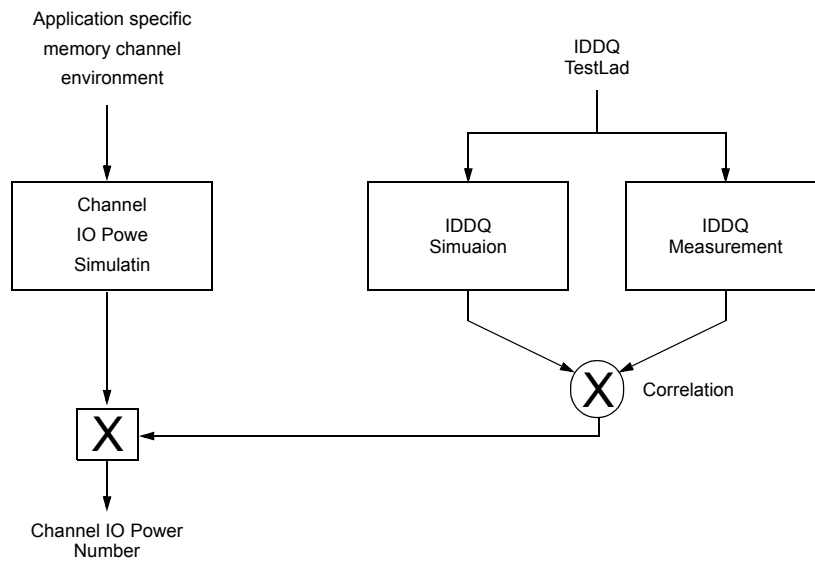

Figure 2 - Correlation from simulated Channel IO Power to actual Channel IO Power supported by IDDQ Measurement

Table 1-Timings used for IDD, IPP and IDDQ Measurement-Loop Patterns

Symbol	DDR4-1600	DDR4-1866	DDR4-2133	DDR4-2400	DDR4-2666	DDR4-2933	DDR4-3200	Unit
	11-11-11	13-13-13	15-15-15	17-17-17	19-19-19	21-21-21	22-22-22	
tCK	1.25	1.071	0.937	0.833	0.75	0.682	0.625	ns
CL	11	13	15	17	19	21	22	nCK
CWL	11	12	14	16	18	20	20	nCK
nRCD	11	13	15	17	19	21	22	nCK
nRC	39	45	51	56	62	68	74	nCK
nRAS	28	32	36	39	43	47	52	nCK
nRP	11	13	15	17	19	21	22	nCK
nFAW	x4	16	16	16	16	16	16	nCK
	x8	20	22	23	26	28	31	nCK
	x16	28	28	32	36	40	44	nCK
nRRDS	x4	4	4	4	4	4	4	nCK
	x8	4	4	4	4	4	4	nCK
	x16	5	5	6	7	8	8	nCK
nRRDL	x4	5	5	6	6	7	8	nCK
	x8	5	5	6	6	7	8	nCK
	x16	6	6	7	8	9	10	nCK
tCCD_S	4	4	4	4	4	4	4	nCK
tCCD_L	5	5	6	6	7	8	8	nCK
tWTR_S	2	3	3	3	4	4	4	nCK
tWTR_L	6	7	8	9	10	11	12	nCK
nRFC 2Gb	128	150	171	193	214	235	256	nCK
nRFC 4Gb	208	243	278	313	347	382	416	nCK
nRFC 8Gb	280	327	374	421	467	514	560	nCK
nRFC 16Gb	440	514	587	661	734	807	880	nCK
TBD								nCK

Table 2 -Basic IDD, IPP and IDDQ Measurement Conditions

Symbol	Description
IDD0	Operating One Bank Active-Precharge Current (AL=0) CKE: High; External clock: On; tCK, nRC, nRAS, CL: see Table 1; BL: 8 ¹ ; AL: 0; CS_n: High between ACT and PRE; Command, Address, Bank Group Address, Bank Address Inputs: partially toggling according to Table 3; Data IO: VDDQ; DM_n: stable at 1; Bank Activity: Cycling with one bank active at a time: 0,0,1,1,2,2,... (see Table 3); Output Buffer and RTT: Enabled in Mode Registers ² ; ODT Signal: stable at 0; Pattern Details: see Table 3
IDD0A	Operating One Bank Active-Precharge Current (AL=CL-1) AL = CL-1, Other conditions: see IDD0
IPP0	Operating One Bank Active-Precharge IPP Current Same condition with IDD0
IDD1	Operating One Bank Active-Read-Precharge Current (AL=0) CKE: High; External clock: On; tCK, nRC, nRAS, nRCD, CL: see Table 1; BL: 8 ¹ ; AL: 0; CS_n: High between ACT, RD and PRE; Command, Address, Bank Group Address, Bank Address Inputs, Data IO: partially toggling according to Table 4; DM_n: stable at 1; Bank Activity: Cycling with one bank active at a time: 0,0,1,1,2,2,... (see Table 4); Output Buffer and RTT: Enabled in Mode Registers ² ; ODT Signal: stable at 0; Pattern Details: see Table 4
IDD1A	Operating One Bank Active-Read-Precharge Current (AL=CL-1) AL = CL-1, Other conditions: see IDD1
IPP1	Operating One Bank Active-Read-Precharge IPP Current Same condition with IDD1
IDD2N	Precharge Standby Current (AL=0) CKE: High; External clock: On; tCK, CL: see Table 1; BL: 8 ¹ ; AL: 0; CS_n: stable at 1; Command, Address, Bank Group Address, Bank Address Inputs: partially toggling according to Table 5; Data IO: VDDQ; DM_n: stable at 1; Bank Activity: all banks closed; Output Buffer and RTT: Enabled in Mode Registers ² ; ODT Signal: stable at 0; Pattern Details: see Table 5
IDD2NA	Precharge Standby Current (AL=CL-1) AL = CL-1, Other conditions: see IDD2N
IPP2N	Precharge Standby IPP Current Same condition with IDD2N
IDD2NT	Precharge Standby ODT Current CKE: High; External clock: On; tCK, CL: see Table 1; BL: 8 ¹ ; AL: 0; CS_n: stable at 1; Command, Address, Bank Group Address, Bank Address Inputs: partially toggling according to Table 6; Data IO: VSSQ; DM_n: stable at 1; Bank Activity: all banks closed; Output Buffer and RTT: Enabled in Mode Registers ² ; ODT Signal: toggling according to Table 6; Pattern Details: see Table 6
IDDQ2NT (Optional)	Precharge Standby ODT IDDQ Current Same definition like for IDD2NT, however measuring IDDQ current instead of IDD current
IDD2NL	Precharge Standby Current with CAL enabled Same definition like for IDD2N, CAL enabled ³
IDD2NG	Precharge Standby Current with Gear Down mode enabled Same definition like for IDD2N, Gear Down mode enabled ^{3,5}
IDD2ND	Precharge Standby Current with DLL disabled Same definition like for IDD2N, DLL disabled ³

IDD2N_par	Precharge Standby Current with CA parity enabled Same definition like for IDD2N, CA parity enabled ³
IDD2P	Precharge Power-Down Current CKE: Low; External clock: On; tCK, CL: see Table 1; BL: 8 ¹ ; AL: 0; CS_n: stable at 1; Command, Address, Bank Group Address, Bank Address Inputs: stable at 0; Data IO: VDDQ; DM_n: stable at 1; Bank Activity: all banks closed; Output Buffer and RTT: Enabled in Mode Registers ² ; ODT Signal: stable at 0
IPP2P	Precharge Power-Down IPP Current Same condition with IDD2P
IDD2Q	Precharge Quiet Standby Current CKE: High; External clock: On; tCK, CL: see Table 1; BL: 8 ¹ ; AL: 0; CS_n: stable at 1; Command, Address, Bank Group Address, Bank Address Inputs: stable at 0; Data IO: VDDQ; DM_n: stable at 1; Bank Activity: all banks closed; Output Buffer and RTT: Enabled in Mode Registers ² ; ODT Signal: stable at 0
IDD3N	Active Standby Current CKE: High; External clock: On; tCK, CL: see Table 1; BL: 8 ¹ ; AL: 0; CS_n: stable at 1; Command, Address, Bank Group Address, Bank Address Inputs: partially toggling according to Table 5; Data IO: VDDQ; DM_n: stable at 1; Bank Activity: all banks open; Output Buffer and RTT: Enabled in Mode Registers ² ; ODT Signal: stable at 0; Pattern Details: see Table 5
IDD3NA	Active Standby Current (AL=CL-1) AL = CL-1, Other conditions: see IDD3N
IPP3N	Active Standby IPP Current Same condition with IDD3N
IDD3P	Active Power-Down Current CKE: Low; External clock: On; tCK, CL: see Table 1; BL: 8 ¹ ; AL: 0; CS_n: stable at 1; Command, Address, Bank Group Address, Bank Address Inputs: stable at 0; Data IO: VDDQ; DM_n: stable at 1; Bank Activity: all banks open; Output Buffer and RTT: Enabled in Mode Registers ² ; ODT Signal: stable at 0
IPP3P	Active Power-Down IPP Current Same condition with IDD3P
IDD4R	Operating Burst Read Current CKE: High; External clock: On; tCK, CL: see Table 1; BL: 8 ² ; AL: 0; CS_n: High between RD; Command, Address, Bank Group Address, Bank Address Inputs: partially toggling according to Table 7; Data IO: seamless read data burst with different data between one burst and the next one according to Table 7; DM_n: stable at 1; Bank Activity: all banks open, RD commands cycling through banks: 0,0,1,1,2,2,... (see Table 7); Output Buffer and RTT: Enabled in Mode Registers ² ; ODT Signal: stable at 0; Pattern Details: see Table 7
IDD4RA	Operating Burst Read Current (AL=CL-1) AL = CL-1, Other conditions: see IDD4R
IDD4RB	Operating Burst Read Current with Read DBI Read DBI enabled³, Other conditions: see IDD4R
IPP4R	Operating Burst Read IPP Current Same condition with IDD4R
IDDQ4R (Optional)	Operating Burst Read IDDQ Current Same definition like for IDD4R, however measuring IDDQ current instead of IDD current
IDDQ4RB (Optional)	Operating Burst Read IDDQ Current with Read DBI Same definition like for IDD4RB, however measuring IDDQ current instead of IDD current

IDD4W	Operating Burst Write Current CKE: High; External clock: On; tCK, CL: see Table 1; BL: 8 ¹ ; AL: 0; CS_n: High between WR; Command, Address, Bank Group Address, Bank Address Inputs: partially toggling according to Table 8; Data IO: seamless write data burst with different data between one burst and the next one according to Table 8; DM_n: stable at 1; Bank Activity: all banks open, WR commands cycling through banks: 0,0,1,1,2,2,... (see Table 8); Output Buffer and RTT: Enabled in Mode Registers ² ; ODT Signal: stable at HIGH; Pattern Details: see Table 8
IDD4WA	Operating Burst Write Current (AL=CL-1) AL = CL-1, Other conditions: see IDD4W
IDD4WB	Operating Burst Write Current with Write DBI Write DBI enabled³, Other conditions: see IDD4W
IDD4WC	Operating Burst Write Current with Write CRC Write CRC enabled³, Other conditions: see IDD4W
IDD4W_par	Operating Burst Write Current with CA Parity CA Parity enabled³, Other conditions: see IDD4W
IPP4W	Operating Burst Write IPP Current Same condition with IDD4W
IDD5B	Burst Refresh Current (1X REF) CKE: High; External clock: On; tCK, CL, nRFC: see Table 1; BL: 8 ¹ ; AL: 0; CS_n: High between REF; Command, Address, Bank Group Address, Bank Address Inputs: partially toggling according to Table 9; Data IO: VDDQ; DM_n: stable at 1; Bank Activity: REF command every nRFC (see Table 9); Output Buffer and RTT: Enabled in Mode Registers ² ; ODT Signal: stable at 0; Pattern Details: see Table 9
IPP5B	Burst Refresh Write IPP Current (1X REF) Same condition with IDD5B
IDD5F2	Burst Refresh Current (2X REF) tRFC=tRFC_x2, Other conditions: see IDD5B
IPP5F2	Burst Refresh Write IPP Current (2X REF) Same condition with IDD5F2
IDD5F4	Burst Refresh Current (4X REF) tRFC=tRFC_x4, Other conditions: see IDD5B
IPP5F4	Burst Refresh Write IPP Current (4X REF) Same condition with IDD5F4
IDD6N	Self Refresh Current: Normal Temperature Range T_{CASE}: 0 - 85°C; Low Power Array Self Refresh (LP ASR) : Normal ⁴ ; CKE: Low; External clock: Off; CK_t and CK_c#: LOW; CL: see Table 1; BL: 8 ¹ ; AL: 0; CS_n#, Command, Address, Bank Group Address, Bank Address, Data IO: High; DM_n: stable at 1; Bank Activity: Self-Refresh operation; Output Buffer and RTT: Enabled in Mode Registers ² ; ODT Signal: MID-LEVEL
IPP6N	Self Refresh IPP Current: Normal Temperature Range Same condition with IDD6N
IDD6E	Self-Refresh Current: Extended Temperature Range⁵⁾ T_{CASE}: 0 - 95°C; Low Power Array Self Refresh (LP ASR) : Extended ⁴ ; CKE: Low; External clock: Off; CK_t and CK_c: LOW; CL: see Table 1; BL: 8 ¹ ; AL: 0; CS_n, Command, Address, Bank Group Address, Bank Address, Data IO: High; DM_n: stable at 1; Bank Activity: Extended Temperature Self-Refresh operation; Output Buffer and RTT: Enabled in Mode Registers ² ; ODT Signal: MID-LEVEL
IPP6E	Self Refresh IPP Current: Extended Temperature Range Same condition with IDD6E

IDD6R	Self-Refresh Current: Reduced Temperature Range T_{CASE} : 0 - TBD (~35-45)°C; Low Power Array Self Refresh (LP ASR) : Reduced ⁴ ; CKE : Low; External clock : Off; CK_t and CK_c# : LOW; CL : see Table 1; BL : 8 ¹ ; AL : 0; CS_n# , Command , Address , Bank Group Address , Bank Address , Data IO : High; DM_n :stable at 1; Bank Activity : Extended Temperature Self-Refresh operation; Output Buffer and RTT : Enabled in Mode Registers ² ; ODT Signal : MID-LEVEL
IPP6R	Self Refresh IPP Current: Reduced Temperature Range Same condition with IDD6R
IDD6A	Auto Self-Refresh Current T_{CASE} : 0 - 95°C; Low Power Array Self Refresh (LP ASR) : Auto ⁴ ; CKE : Low; External clock : Off; CK_t and CK_c# : LOW; CL : see Table 1; BL : 8 ¹ ; AL : 0; CS_n# , Command , Address , Bank Group Address , Bank Address , Data IO : High; DM_n :stable at 1; Bank Activity : Auto Self-Refresh operation; Output Buffer and RTT : Enabled in Mode Registers ² ; ODT Signal : MID-LEVEL
IPP6A	Auto Self-Refresh IPP Current Same condition with IDD6A
IDD7	Operating Bank Interleave Read Current CKE : High; External clock : On; tCK , nRC , nRAS , nRCD , nRRD , nFAW , CL : see Table 1; BL : 8 ¹ ; AL : CL-1; CS_n : High between ACT and RDA; Command , Address , Bank Group Address , Bank Address Inputs : partially toggling according to Table 10; Data IO : read data bursts with different data between one burst and the next one according to Table 10; DM_n : stable at 1; Bank Activity : two times interleaved cycling through banks (0, 1, ...7) with different addressing, see Table 10; Output Buffer and RTT : Enabled in Mode Registers ² ; ODT Signal : stable at 0; Pattern Details : see Table 10
IPP7	Operating Bank Interleave Read IPP Current Same condition with IDD7
IDD8	Maximum Power Down Current TBD
IPP8	Maximum Power Down IPP Current Same condition with IDD8

NOTE :

1. Burst Length: BL8 fixed by MRS: set MR0 [A1:0=00].
2. Output Buffer Enable
 - set MR1 [A12 = 0] : Qoff = Output buffer enabled
 - set MR1 [A2:1 = 00] : Output Driver Impedance Control = RZQ/7
 - RTT_Nom enable
 - set MR1 [A10:8 = 011] : RTT_NOM = RZQ/6
 - RTT_WR enable
 - set MR2 [A10:9 = 01] : RTT_WR = RZQ/2
 - RTT_PARK disable
 - set MR5 [A8:6 = 000]
3. CAL enabled : set MR4 [A8:6 = 001] : 1600MT/s
010] : 1866MT/s, 2133MT/s
011] : 2400MT/s
 - Gear Down mode enabled :set MR3 [A3 = 1] : 1/4 Rate
 - DLL disabled : set MR1 [A0 = 0]
 - CA parity enabled :set MR5 [A2:0 = 001] : 1600MT/s,1866MT/s, 2133MT/s
010] : 2400MT/s
 - Read DBI enabled : set MR5 [A12 = 1]
 - Write DBI enabled : set :MR5 [A11 = 1]
4. Low Power Array Self Refresh (LP ASR) : set MR2 [A7:6 = 00] : Normal
 - 01] : Reduced Temperature range
 - 10] : Extended Temperature range
 - 11] : Auto Self Refresh
5. IDD2NG should be measured after sync pulse(NOP) input.

Table 3 - IDD0, IDD0A and IPP0 Measurement-Loop Pattern¹

CK_t / CK_c	CKE	Sub-Loop	Cycle Number	Command	CS_n	ACT_n	RAS_n/ A16	CAS_n/ A15	WE_n/ A14	ODT	C[2:0] ³	BG[1:0] ²	BA[1:0]	A12/BC_n	A[17,13,11]	A[10]/AP	A[9:7]	A[6:3]	A[2:0]	Data ⁴			
toggling	Static High	0	0	ACT	0	0	0	0	0	0	0	0	0	0	0	0	0	0	0	0	-		
			1,2	D, D	1	0	0	0	0	0	0	0	0	0	0	0	0	0	0	0	0	-	
			3,4	D_#, D_#	1	1	1	1	1	1	0	0	3 ²	3	0	0	0	7	F	0	0	-	
			...	repeat pattern 1...4 until nRAS - 1, truncate if necessary																			
			nRAS	PRE	0	1	0	1	0	0	0	0	0	0	0	0	0	0	0	0	0	0	-
			...	repeat pattern 1...4 until nRC - 1, truncate if necessary																			
		1	1*nRC	repeat Sub-Loop 0, use BG[1:0]² = 1, BA[1:0] = 1 instead																			
		2	2*nRC	repeat Sub-Loop 0, use BG[1:0]² = 0, BA[1:0] = 2 instead																			
		3	3*nRC	repeat Sub-Loop 0, use BG[1:0]² = 1, BA[1:0] = 3 instead																			
		4	4*nRC	repeat Sub-Loop 0, use BG[1:0]² = 0, BA[1:0] = 1 instead																			
		5	5*nRC	repeat Sub-Loop 0, use BG[1:0]² = 1, BA[1:0] = 2 instead																			
		6	6*nRC	repeat Sub-Loop 0, use BG[1:0]² = 0, BA[1:0] = 3 instead																			
		7	7*nRC	repeat Sub-Loop 0, use BG[1:0]² = 1, BA[1:0] = 0 instead																			
		8	8*nRC	repeat Sub-Loop 0, use BG[1:0]² = 2, BA[1:0] = 0 instead																			
		9	9*nRC	repeat Sub-Loop 0, use BG[1:0]² = 3, BA[1:0] = 1 instead																			
10	10*nRC	repeat Sub-Loop 0, use BG[1:0]² = 2, BA[1:0] = 2 instead																					
11	11*nRC	repeat Sub-Loop 0, use BG[1:0]² = 3, BA[1:0] = 3 instead																					
12	12*nRC	repeat Sub-Loop 0, use BG[1:0]² = 2, BA[1:0] = 1 instead																					
13	13*nRC	repeat Sub-Loop 0, use BG[1:0]² = 3, BA[1:0] = 2 instead																					
14	14*nRC	repeat Sub-Loop 0, use BG[1:0]² = 2, BA[1:0] = 3 instead																					
15	15*nRC	repeat Sub-Loop 0, use BG[1:0]² = 3, BA[1:0] = 0 instead																					

NOTE:

1. DQS_t, DQS_c are VDDQ.
2. BG1 is don't care for x16 device
3. C[2:0] are used only for 3DS device
4. DQ signals are VDDQ.

Table 4 - IDD1, IDD1A and IPP1 Measurement-Loop Pattern^{a)}

CK_t, CK_c	CKE	Sub-Loop	Cycle Number	Command	CS_n	ACT_n	RAS_n/A16	CAS_n/A15	WE_n/A14	ODT	C[2:0] ³	BG[1:0] ²	BA[1:0]	A12/BC_n	A[17,13,11]	A[10]/AP	A[9:7]	A[6:3]	A[2:0]	Data ⁴		
toggling Static High		0	0	WR	0	1	1	0	0	1	0	0	0	0	0	0	0	0	0	0	D0=00, D1=FF D2=FF, D3=00 D4=FF, D5=00 D6=00, D7=FF	
			1	D	1	0	0	0	0	1	0	0	0	0	0	0	0	0	0	0	-	
			2,3	D#, D#	1	1	1	1	1	1	1	0	3 ²	3	0	0	0	7	F	0	-	
		1	4	WR	0	1	1	0	0	1	0	1	1	0	0	0	7	F	0	0	0	D0=FF, D1=00 D2=00, D3=FF D4=00, D5=FF D6=FF, D7=00
				5	D	1	0	0	0	0	1	0	0	0	0	0	0	0	0	0	0	-
				6,7	D#, D#	1	1	1	1	1	1	0	3 ²	3	0	0	0	7	F	0	-	
		2	8-11	repeat Sub-Loop 0, use BG[1:0] ² = 0, BA[1:0] = 2 instead																		
		3	12-15	repeat Sub-Loop 1, use BG[1:0] ² = 1, BA[1:0] = 3 instead																		
		4	16-19	repeat Sub-Loop 0, use BG[1:0] ² = 0, BA[1:0] = 1 instead																		
		5	20-23	repeat Sub-Loop 1, use BG[1:0] ² = 1, BA[1:0] = 2 instead																		
		6	24-27	repeat Sub-Loop 0, use BG[1:0] ² = 0, BA[1:0] = 3 instead																		
		7	28-31	repeat Sub-Loop 1, use BG[1:0] ² = 1, BA[1:0] = 0 instead																		
		8	32-35	repeat Sub-Loop 0, use BG[1:0] ² = 2, BA[1:0] = 0 instead																		
		9	36-39	repeat Sub-Loop 1, use BG[1:0] ² = 3, BA[1:0] = 1 instead																		
		10	40-43	repeat Sub-Loop 0, use BG[1:0] ² = 2, BA[1:0] = 2 instead																		
11	44-47	repeat Sub-Loop 1, use BG[1:0] ² = 3, BA[1:0] = 3 instead																				
12	48-51	repeat Sub-Loop 0, use BG[1:0] ² = 2, BA[1:0] = 1 instead																				
13	52-55	repeat Sub-Loop 1, use BG[1:0] ² = 3, BA[1:0] = 2 instead																				
14	56-59	repeat Sub-Loop 0, use BG[1:0] ² = 2, BA[1:0] = 3 instead																				
15	60-63	repeat Sub-Loop 1, use BG[1:0] ² = 3, BA[1:0] = 0 instead																				

NOTE:

1. DQS_t, DQS_c are used according to RD Commands, otherwise VDDQ
2. BG1 is don't care for x16 device
3. C[2:0] are used only for 3DS device
4. Burst Sequence driven on each DQ signal by Read Command. Outside burst operation, DQ signals are VDDQ.

Table 5 - IDD2N, IDD2NA, IDD2NL, IDD2NG, IDD2ND, IDD2N_par, IPP2,IDD3N, IDD3NA and IDD3P

Measurement-Loop Pattern¹

CK_t, CK_c	CKE	Sub-Loop	Cycle Number	Command	CS_n	ACT_n	RAS_n/A16	CAS_n/A15	WE_n/A14	ODT	C[2:0] ³	BG[1:0] ²	BA[1:0]	A12/BC_n	A[17,13,11]	A[10]/AP	A[9:7]	A[6:3]	A[2:0]	Data ⁴		
toggling	Static High	0	0	D, D	1	0	0	0	0	0	0	0	0	0	0	0	0	0	0	0	0	
			1	D, D	1	0	0	0	0	0	0	0	0	0	0	0	0	0	0	0	0	0
			2	D#, D#	1	1	1	1	1	1	0	0	3 ²	3	0	0	0	0	7	F	0	0
			3	D#, D#	1	1	1	1	1	1	0	0	3 ²	3	0	0	0	0	7	F	0	0
		1	4-7	repeat Sub-Loop 0, use BG[1:0]² = 1, BA[1:0] = 1 instead																		
		2	8-11	repeat Sub-Loop 0, use BG[1:0]² = 0, BA[1:0] = 2 instead																		
		3	12-15	repeat Sub-Loop 0, use BG[1:0]² = 1, BA[1:0] = 3 instead																		
		4	16-19	repeat Sub-Loop 0, use BG[1:0]² = 0, BA[1:0] = 1 instead																		
		5	20-23	repeat Sub-Loop 0, use BG[1:0]² = 1, BA[1:0] = 2 instead																		
		6	24-27	repeat Sub-Loop 0, use BG[1:0]² = 0, BA[1:0] = 3 instead																		
		7	28-31	repeat Sub-Loop 0, use BG[1:0]² = 1, BA[1:0] = 0 instead																		
		8	32-35	repeat Sub-Loop 0, use BG[1:0]² = 2, BA[1:0] = 0 instead																		
		9	36-39	repeat Sub-Loop 0, use BG[1:0]² = 3, BA[1:0] = 1 instead																		
		10	40-43	repeat Sub-Loop 0, use BG[1:0]² = 2, BA[1:0] = 2 instead																		
		11	44-47	repeat Sub-Loop 0, use BG[1:0]² = 3, BA[1:0] = 3 instead																		
		12	48-51	repeat Sub-Loop 0, use BG[1:0]² = 2, BA[1:0] = 1 instead																		
13	52-55	repeat Sub-Loop 0, use BG[1:0]² = 3, BA[1:0] = 2 instead																				
14	56-59	repeat Sub-Loop 0, use BG[1:0]² = 2, BA[1:0] = 3 instead																				
15	60-63	repeat Sub-Loop 0, use BG[1:0]² = 3, BA[1:0] = 0 instead																				

NOTE :

1. DQS_t, DQS_c are VDDQ.
2. BG1 is don't care for x16 device
3. C[2:0] are used only for 3DS device
4. DQ signals are VDDQ.

Table 6 - IDD2NT and IDDQ2NT Measurement-Loop Pattern¹

CK_t, CK_c	CKE	Sub-Loop	Cycle Number	Command	CS_n	ACT_n	RAS_n/A16	CAS_n/A15	WE_n/A14	ODT	C[2:0] ³	BG[1:0] ²	BA[1:0]	A12/BC_n	A[17,13,11]	A[10]/AP	A[9:7]	A[6:3]	A[2:0]	Data ⁴		
toggling	Static High	0	0	D, D	1	0	0	0	0	0	0	0	0	0	0	0	0	0	0	0	-	
			1	D, D	1	0	0	0	0	0	0	0	0	0	0	0	0	0	0	0	0	-
			2	D#, D#	1	1	1	1	1	1	0	0	3 ²	3	0	0	0	7	F	0	0	-
			3	D#, D#	1	1	1	1	1	1	0	0	3 ²	3	0	0	0	7	F	0	0	-
		1	4-7	repeat Sub-Loop 0, but ODT = 1 and BG[1:0]² = 1, BA[1:0] = 1 instead																		
		2	8-11	repeat Sub-Loop 0, but ODT = 0 and BG[1:0]² = 0, BA[1:0] = 2 instead																		
		3	12-15	repeat Sub-Loop 0, but ODT = 1 and BG[1:0]² = 1, BA[1:0] = 3 instead																		
		4	16-19	repeat Sub-Loop 0, but ODT = 0 and BG[1:0]² = 0, BA[1:0] = 1 instead																		
		5	20-23	repeat Sub-Loop 0, but ODT = 1 and BG[1:0]² = 1, BA[1:0] = 2 instead																		
		6	24-27	repeat Sub-Loop 0, but ODT = 0 and BG[1:0]² = 0, BA[1:0] = 3 instead																		
		7	28-31	repeat Sub-Loop 0, but ODT = 1 and BG[1:0]² = 1, BA[1:0] = 0 instead																		
		8	32-35	repeat Sub-Loop 0, but ODT = 0 and BG[1:0]² = 2, BA[1:0] = 0 instead																		
		9	36-39	repeat Sub-Loop 0, but ODT = 1 and BG[1:0]² = 3, BA[1:0] = 1 instead																		
		10	40-43	repeat Sub-Loop 0, but ODT = 0 and BG[1:0]² = 2, BA[1:0] = 2 instead																		
		11	44-47	repeat Sub-Loop 0, but ODT = 1 and BG[1:0]² = 3, BA[1:0] = 3 instead																		
12	48-51	repeat Sub-Loop 0, but ODT = 0 and BG[1:0]² = 2, BA[1:0] = 1 instead																				
13	52-55	repeat Sub-Loop 0, but ODT = 1 and BG[1:0]² = 3, BA[1:0] = 2 instead																				
14	56-59	repeat Sub-Loop 0, but ODT = 0 and BG[1:0]² = 2, BA[1:0] = 3 instead																				
15	60-63	repeat Sub-Loop 0, but ODT = 1 and BG[1:0]² = 3, BA[1:0] = 0 instead																				

NOTE :

1. DQS_t, DQS_c are VDDQ.
2. BG1 is don't care for x16 device
3. C[2:0] are used only for 3DS device
4. DQ signals are VDDQ.

Table 7 - IDD4R, IDDR4RA, IDD4RB and IDDQ4R Measurement-Loop Pattern¹

CK_t, CK_c	CKE	Sub-Loop	Cycle Number	Command	CS_n	ACT_n	RAS_n/A16	CAS_n/A15	WE_n/A14	ODT	C[2:0] ³	BG[1:0] ²	BA[1:0]	A12/BC_n	A[17,13,11]	A[10]/AP	A[9:7]	A[6:3]	A[2:0]	Data ⁴			
toggling	Static High	0	0	RD	0	1	1	0	1	0	0	0	0	0	0	0	0	0	0	0	D0=00, D1=FF D2=FF, D3=00 D4=FF, D5=00 D6=00, D7=FF		
			1	D	1	0	0	0	0	0	0	0	0	0	0	0	0	0	0	0	0	-	
			2,3	D#, D#	1	1	1	1	1	1	0	0	3 ²	3	0	0	0	0	7	F	0	-	
		1	4	RD	0	1	1	0	1	0	0	0	1	1	0	0	0	0	7	F	0	D0=FF, D1=00 D2=00, D3=FF D4=00, D5=FF D6=FF, D7=00	
				5	D	1	0	0	0	0	0	0	0	0	0	0	0	0	0	0	0	0	-
				6,7	D#, D#	1	1	1	1	1	1	0	0	3 ²	3	0	0	0	0	7	F	0	-
		2	8-11	repeat Sub-Loop 0, use BG[1:0]² = 0, BA[1:0] = 2 instead																			
		3	12-15	repeat Sub-Loop 1, use BG[1:0]² = 1, BA[1:0] = 3 instead																			
		4	16-19	repeat Sub-Loop 0, use BG[1:0]² = 0, BA[1:0] = 1 instead																			
		5	20-23	repeat Sub-Loop 1, use BG[1:0]² = 1, BA[1:0] = 2 instead																			
		6	24-27	repeat Sub-Loop 0, use BG[1:0]² = 0, BA[1:0] = 3 instead																			
		7	28-31	repeat Sub-Loop 1, use BG[1:0]² = 1, BA[1:0] = 0 instead																			
		8	32-35	repeat Sub-Loop 0, use BG[1:0]² = 2, BA[1:0] = 0 instead																			
		9	36-39	repeat Sub-Loop 1, use BG[1:0]² = 3, BA[1:0] = 1 instead																			
		10	40-43	repeat Sub-Loop 0, use BG[1:0]² = 2, BA[1:0] = 2 instead																			
11	44-47	repeat Sub-Loop 1, use BG[1:0]² = 3, BA[1:0] = 3 instead																					
12	48-51	repeat Sub-Loop 0, use BG[1:0]² = 2, BA[1:0] = 1 instead																					
13	52-55	repeat Sub-Loop 1, use BG[1:0]² = 3, BA[1:0] = 2 instead																					
14	56-59	repeat Sub-Loop 0, use BG[1:0]² = 2, BA[1:0] = 3 instead																					
15	60-63	repeat Sub-Loop 1, use BG[1:0]² = 3, BA[1:0] = 0 instead																					

NOTE :

1. DQS_t, DQS_c are used according to RD Commands, otherwise VDDQ.
2. BG1 is don't care for x16 device
3. C[2:0] are used only for 3DS device
4. Burst Sequence driven on each DQ signal by Read Command.

Table 8 - IDD4W, IDD4WA, IDD4WB and IDD4W_par Measurement-Loop Pattern¹

CK_t, CK_c	CKE	Sub-Loop	Cycle Number	Command	CS_n	ACT_n	RAS_n/A16	CAS_n/A15	WE_n/A14	ODT	C[2:0] ³	BG[1:0] ²	BA[1:0]	A12/BC_n	A[17,13,11]	A[10]/AP	A[9:7]	A[6:3]	A[2:0]	Data ⁴		
toggling	Static High	0	0	WR	0	1	1	0	1	1	0	0	0	0	0	0	0	0	0	0	D0=00, D1=FF D2=FF, D3=00 D4=FF, D5=00 D6=00, D7=FF	
			1	D	1	0	0	0	0	1	0	0	0	0	0	0	0	0	0	0	-	
			2,3	D#, D#	1	1	1	1	1	1	0	3 ²	3	0	0	0	7	F	0	-		
		1	4	WR	0	1	1	0	1	1	0	1	1	0	0	0	7	F	0	0	D0=FF, D1=00 D2=00, D3=FF D4=00, D5=FF D6=FF, D7=00	
				5	D	1	0	0	0	0	1	0	0	0	0	0	0	0	0	0	-	
				6,7	D#, D#	1	1	1	1	1	1	0	3 ²	3	0	0	0	7	F	0	-	
		2	8-11	repeat Sub-Loop 0, use BG[1:0]² = 0, BA[1:0] = 2 instead																		
		3	12-15	repeat Sub-Loop 1, use BG[1:0]² = 1, BA[1:0] = 3 instead																		
		4	16-19	repeat Sub-Loop 0, use BG[1:0]² = 0, BA[1:0] = 1 instead																		
		5	20-23	repeat Sub-Loop 1, use BG[1:0]² = 1, BA[1:0] = 2 instead																		
		6	24-27	repeat Sub-Loop 0, use BG[1:0]² = 0, BA[1:0] = 3 instead																		
		7	28-31	repeat Sub-Loop 1, use BG[1:0]² = 1, BA[1:0] = 0 instead																		
		8	32-35	repeat Sub-Loop 0, use BG[1:0]² = 2, BA[1:0] = 0 instead																		
		9	36-39	repeat Sub-Loop 1, use BG[1:0]² = 3, BA[1:0] = 1 instead																		
		10	40-43	repeat Sub-Loop 0, use BG[1:0]² = 2, BA[1:0] = 2 instead																		
11	44-47	repeat Sub-Loop 1, use BG[1:0]² = 3, BA[1:0] = 3 instead																				
12	48-51	repeat Sub-Loop 0, use BG[1:0]² = 2, BA[1:0] = 1 instead																				
13	52-55	repeat Sub-Loop 1, use BG[1:0]² = 3, BA[1:0] = 2 instead																				
14	56-59	repeat Sub-Loop 0, use BG[1:0]² = 2, BA[1:0] = 3 instead																				
15	60-63	repeat Sub-Loop 1, use BG[1:0]² = 3, BA[1:0] = 0 instead																				

NOTE :

1. DQS_t, DQS_c are used according to WR Commands, otherwise VDDQ.
2. BG1 is don't care for x16 device
3. C[2:0] are used only for 3DS device
4. Burst Sequence driven on each DQ signal by Write Command.

Table 9 - IDD4WC Measurement-Loop Pattern¹

CK_t, CK_c	CKE	Sub-Loop	Cycle Number	Command	CS_n	ACT_n	RAS_n/A16	CAS_n/A15	WE_n/A14	ODT	C[2:0] ^c	BG[1:0] ^b	BA[1:0]	A12/BC_n	A[17,13,11]	A[10]/AP	A[9:7]	A[6:3]	A[2:0]	Data ^d		
toggling	Static High	0	0	WR	0	1	1	0	1	1	0	0	0	0	0	0	0	0	0	0	D0=00, D1=FF D2=FF, D3=00 D4=FF, D5=00 D6=00, D7=FF D8=CRC	
		1,2	D, D	1	0	0	0	0	0	1	0	0	0	0	0	0	0	0	0	0	-	
		3,4	D#, D#	1	1	1	1	1	1	1	0	3 ²	3	0	0	0	0	7	F	0	-	
		5	WR	0	1	1	0	1	1	1	0	1	1	0	0	0	7	F	0	0	D0=FF, D1=00 D2=00, D3=FF D4=00, D5=FF D6=FF, D7=00 D8=CRC	
		6,7	D, D	1	0	0	0	0	0	1	0	0	0	0	0	0	0	0	0	0	-	
		8,9	D#, D#	1	1	1	1	1	1	1	0	3 ²	3	0	0	0	0	7	F	0	-	
		2	10-14	repeat Sub-Loop 0, use BG[1:0]² = 0, BA[1:0] = 2 instead																		
		3	15-19	repeat Sub-Loop 1, use BG[1:0]² = 1, BA[1:0] = 3 instead																		
		4	20-24	repeat Sub-Loop 0, use BG[1:0]² = 0, BA[1:0] = 1 instead																		
		5	25-29	repeat Sub-Loop 1, use BG[1:0]² = 1, BA[1:0] = 2 instead																		
		6	30-34	repeat Sub-Loop 0, use BG[1:0]² = 0, BA[1:0] = 3 instead																		
		7	35-39	repeat Sub-Loop 1, use BG[1:0]² = 1, BA[1:0] = 0 instead																		
		8	40-44	repeat Sub-Loop 0, use BG[1:0]² = 2, BA[1:0] = 0 instead																		
		9	45-49	repeat Sub-Loop 1, use BG[1:0]² = 3, BA[1:0] = 1 instead																		
		10	50-54	repeat Sub-Loop 0, use BG[1:0]² = 2, BA[1:0] = 2 instead																		
11	55-59	repeat Sub-Loop 1, use BG[1:0]² = 3, BA[1:0] = 3 instead																				
12	60-64	repeat Sub-Loop 0, use BG[1:0]² = 2, BA[1:0] = 1 instead																				
13	65-69	repeat Sub-Loop 1, use BG[1:0]² = 3, BA[1:0] = 2 instead																				
14	70-74	repeat Sub-Loop 0, use BG[1:0]² = 2, BA[1:0] = 3 instead																				
15	75-79	repeat Sub-Loop 1, use BG[1:0]² = 3, BA[1:0] = 0 instead																				

For x4 and x8 only

NOTE :

1. DQS_t, DQS_c are VDDQ.
2. BG1 is don't care for x16 device.
3. C[2:0] are used only for 3DS device.
4. Burst Sequence driven on each DQ signal by Write Command.

Table 10 - IDD5B Measurement-Loop Pattern¹

CK_t, CK_c	CKE	Sub-Loop	Cycle Number	Command	CS_n	ACT_n	RAS_n/A16	CAS_n/A15	WE_n/A14	ODT	C[2:0] ³	BG[1:0] ²	BA[1:0]	A12/BC_n	A[17,13,11]	A[10]/AP	A[9:7]	A[6:3]	A[2:0]	Data ⁴		
toggling	Static High	0	0	REF	1	0	0	0	0	0	0	0	0	0	0	0	0	0	0	-		
		1	1	D	1	0	0	0	0	0	0	0	0	0	0	0	0	0	0	0	-	
			2	D	1	0	0	0	0	0	0	0	0	0	0	0	0	0	0	0	0	-
			3	D#, D#	1	1	1	1	1	1	0	0	3 ²	3	0	0	0	7	F	0	0	-
			4	D#, D#	1	1	1	1	1	1	0	0	3 ²	3	0	0	0	7	F	0	0	-
			4-7	repeat pattern 1...4, use BG[1:0]² = 1, BA[1:0] = 1 instead																		
			8-11	repeat pattern 1...4, use BG[1:0]² = 0, BA[1:0] = 2 instead																		
			12-15	repeat pattern 1...4, use BG[1:0]² = 1, BA[1:0] = 3 instead																		
			16-19	repeat pattern 1...4, use BG[1:0]² = 0, BA[1:0] = 1 instead																		
			20-23	repeat pattern 1...4, use BG[1:0]² = 1, BA[1:0] = 2 instead																		
			24-27	repeat pattern 1...4, use BG[1:0]² = 0, BA[1:0] = 3 instead																		
			28-31	repeat pattern 1...4, use BG[1:0]² = 1, BA[1:0] = 0 instead																		
			32-35	repeat pattern 1...4, use BG[1:0]² = 2, BA[1:0] = 0 instead																		
			36-39	repeat pattern 1...4, use BG[1:0]² = 3, BA[1:0] = 1 instead																		
			40-43	repeat pattern 1...4, use BG[1:0]² = 2, BA[1:0] = 2 instead																		
			44-47	repeat pattern 1...4, use BG[1:0]² = 3, BA[1:0] = 3 instead																		
			48-51	repeat pattern 1...4, use BG[1:0]² = 2, BA[1:0] = 1 instead																		
			52-55	repeat pattern 1...4, use BG[1:0]² = 3, BA[1:0] = 2 instead																		
			56-59	repeat pattern 1...4, use BG[1:0]² = 2, BA[1:0] = 3 instead																		
			60-63	repeat pattern 1...4, use BG[1:0]² = 3, BA[1:0] = 0 instead																		
			2	64 ... nRFC - 1	repeat Sub-Loop 1, Truncate, if necessary																	

NOTE :

1. DQS_t, DQS_c are VDDQ.
2. BG1 is don't care for x16 device.
3. C[2:0] are used only for 3DS device.
4. DQ signals are VDDQ.

Table 11 - IDD7 Measurement-Loop Pattern¹

CK_t, CK_c	CKE	Sub-Loop	Cycle Number	Command	CS_n	ACT_n	RAS_n/A16	CAS_n/A15	WE_n/A14	ODT	C[2:0] ³	BG[1:0] ²	BA[1:0]	A12/BC_n	A[17,13,11]	A[10]/AP	A[9:7]	A[6:3]	A[2:0]	Data ⁴		
toggling	Static High	0	0	ACT	0	0	0	0	0	0	0	0	0	0	0	0	0	0	0	-		
		1	1	RDA	0	1	1	0	1	0	0	0	0	0	0	0	1	0	0	0	D0=00, D1=FF D2=FF, D3=00 D4=FF, D5=00 D6=00, D7=FF	
			2	D	1	0	0	0	0	0	0	0	0	0	0	0	0	0	0	0	-	
			3	D#	1	1	1	1	1	1	0	0	3 ²	3	0	0	0	0	7	F	0	-
			...	repeat pattern 2...3 until nRRD - 1, if nRRD > 4. Truncate if necessary																		
			1	nRRD	ACT	0	0	0	0	0	0	0	0	1	1	0	0	0	0	0	0	-
			nRRD + 1	RDA	0	1	1	0	1	0	0	0	0	1	1	0	0	1	0	0	0	D0=FF, D1=00 D2=00, D3=FF D4=00, D5=FF D6=FF, D7=00
			...	repeat pattern 2 ... 3 until 2*nRRD - 1, if nRRD > 4. Truncate if necessary																		
			2	2*nRRD	repeat Sub-Loop 0, use BG[1:0]² = 0, BA[1:0] = 2 instead																	
			3	3*nRRD	repeat Sub-Loop 1, use BG[1:0]² = 1, BA[1:0] = 3 instead																	
			4	4*nRRD	repeat pattern 2 ... 3 until nFAW - 1, if nFAW > 4*nRRD. Truncate if necessary																	
			5	nFAW	repeat Sub-Loop 0, use BG[1:0]² = 0, BA[1:0] = 1 instead																	
			6	nFAW + nRRD	repeat Sub-Loop 1, use BG[1:0]² = 1, BA[1:0] = 2 instead																	
			7	nFAW + 2*nRRD	repeat Sub-Loop 0, use BG[1:0]² = 0, BA[1:0] = 3 instead																	
			8	nFAW + 3*nRRD	repeat Sub-Loop 1, use BG[1:0]² = 1, BA[1:0] = 0 instead																	
			9	nFAW + 4*nRRD	repeat Sub-Loop 4																	
			10	2*nFAW	repeat Sub-Loop 0, use BG[1:0]² = 2, BA[1:0] = 0 instead																	
			11	2*nFAW + nRRD	repeat Sub-Loop 1, use BG[1:0]² = 3, BA[1:0] = 1 instead																	
			12	2*nFAW + 2*nRRD	repeat Sub-Loop 0, use BG[1:0]² = 2, BA[1:0] = 2 instead																	
			13	2*nFAW + 3*nRRD	repeat Sub-Loop 1, use BG[1:0]² = 3, BA[1:0] = 3 instead																	
	14	2*nFAW + 4*nRRD	repeat Sub-Loop 4																			
	15	3*nFAW	repeat Sub-Loop 0, use BG[1:0]² = 2, BA[1:0] = 1 instead																			
	16	3*nFAW + nRRD	repeat Sub-Loop 1, use BG[1:0]² = 3, BA[1:0] = 2 instead																			
	17	3*nFAW + 2*nRRD	repeat Sub-Loop 0, use BG[1:0]² = 2, BA[1:0] = 3 instead																			
	18	3*nFAW + 3*nRRD	repeat Sub-Loop 1, use BG[1:0]² = 3, BA[1:0] = 0 instead																			
	19	3*nFAW + 4*nRRD	repeat Sub-Loop 4																			
	20	4*nFAW	repeat pattern 2 ... 3 until nRC - 1, if nRC > 4*nFAW. Truncate if necessary																			

NOTE :

1. DQS_t, DQS_c are VDDQ.
2. BG1 is don't care for x16 device.
3. C[2:0] are used only for 3DS device.
4. Burst Sequence driven on each DQ signal by Read Command. Outside burst operation, DQ signals are VDDQ

IDD Specifications

Module IDD values in the datasheet are only a calculation based on the component IDD spec and register power. The actual measurements may vary according to DQ loading cap.

8GB, 1Gx 72 R-DIMM: HMA81GR7CJR8N

IDD					unit	note
Symbol	2400	2667	2933	3200		
IDD0	817	832	769	795	mA	
IDD0A	817	841	778	822	mA	
IDD1	939	966	923	959	mA	
IDD1A	966	993	950	995	mA	
IDD2N	736	751	679	714	mA	
IDD2NA	736	751	679	714	mA	
IDD2NT	781	796	724	759	mA	
IDD2NL	673	688	616	651	mA	
IDD2NG	736	751	679	714	mA	
IDD2ND	727	742	670	705	mA	
IDD2NP	736	751	679	714	mA	
IDD2P	477	493	463	497	mA	
IDD2Q	718	724	643	669	mA	
IDD3N	826	841	778	813	mA	
IDD3NA	826	841	778	813	mA	
IDD3P	576	592	562	596	mA	
IDD4R	1578	1677	1715	1832	mA	
IDD4RA	1605	1704	1751	1868	mA	
IDD4RB	1605	1695	1733	1850	mA	
IDD4W	1434	1515	1544	1625	mA	
IDD4WA	1461	1551	1580	1688	mA	
IDD4WB	1389	1461	1490	1580	mA	
IDD4WC	1416	1497	1526	1625	mA	
IDD4WP	1569	1668	1706	1868	mA	
IDD5B	2257	2272	2200	2235	mA	
IDD5F2	1771	1795	1732	1776	mA	
IDD5F4	1636	1660	1597	1641	mA	
IDD6N	211	211	204	204	mA	
IDD6E	274	274	267	267	mA	
IDD6R	148	148	141	141	mA	
IDD6A	274	274	267	267	mA	
IDD7	1794	1857	1805	1859	mA	
IDD8	130	130	123	123	mA	

IPP					unit	note
Symbol	2400	2667	2933	3200		
IPP0	50	50	50	50	mA	
IPP1	59	59	59	59	mA	
IPP2N	29	29	29	29	mA	
IPP2P	29	29	29	29	mA	
IPP3N	144	144	144	144	mA	
IPP3P	144	144	144	144	mA	
IPP4R	171	171	171	171	mA	
IPP4W	171	171	171	171	mA	
IPP5B	567	567	567	567	mA	
IPP5F2	360	369	378	387	mA	
IPP5F4	315	315	315	450	mA	
IPP6N	45	45	45	45	mA	
IPP6E	63	63	63	63	mA	
IPP6R	37	37	37	37	mA	
IPP6A	63	63	63	63	mA	
IPP7	153	162	162	162	mA	
IPP8	29	29	29	29	mA	

16GB, 2Gx 72 R-DIMM: HMA82GR7CJR8N

IDD					unit	note	IPP					unit	note
Symbol	2400	2667	2933	3200			Symbol	2400	2667	2933	3200		
IDD0	1060	1084	1030	1065	mA		IPP0	78	78	78	78	mA	
IDD0A	1060	1093	1039	1092	mA		IPP1	87	87	87	87	mA	
IDD1	1182	1218	1184	1229	mA		IPP2N	58	58	58	58	mA	
IDD1A	1209	1245	1211	1265	mA		IPP2P	58	58	58	58	mA	
IDD2N	979	1003	940	984	mA		IPP3N	288	288	288	288	mA	
IDD2NA	979	1003	940	984	mA		IPP3P	288	288	288	288	mA	
IDD2NT	1069	1093	1030	1074	mA		IPP4R	200	200	200	200	mA	
IDD2NL	853	877	814	858	mA		IPP4W	200	200	200	200	mA	
IDD2NG	979	1003	940	984	mA		IPP5B	596	596	596	596	mA	
IDD2ND	961	985	922	966	mA		IPP5F2	389	398	407	416	mA	
IDD2NP	979	1003	940	984	mA		IPP5F4	344	344	344	479	mA	
IDD2P	648	673	652	695	mA		IPP6N	90	90	90	90	mA	
IDD2Q	943	949	868	894	mA		IPP6E	126	126	126	126	mA	
IDD3N	1159	1183	1138	1182	mA		IPP6R	74	74	74	74	mA	
IDD3NA	1159	1183	1138	1182	mA		IPP6A	126	126	126	126	mA	
IDD3P	846	871	850	893	mA		IPP7	182	191	191	191	mA	
IDD4R	1821	1929	1976	2102	mA		IPP8	58	58	58	58	mA	
IDD4RA	1848	1956	2012	2138	mA								
IDD4RB	1848	1947	1994	2120	mA								
IDD4W	1677	1767	1805	1895	mA								
IDD4WA	1704	1803	1841	1958	mA								
IDD4WB	1632	1713	1751	1850	mA								
IDD4WC	1659	1749	1787	1895	mA								
IDD4WP	1812	1920	1967	2138	mA								
IDD5B	2500	2524	2461	2505	mA								
IDD5F2	2014	2047	1993	2046	mA								
IDD5F4	1879	1912	1858	1911	mA								
IDD6N	400	400	393	393	mA								
IDD6E	526	526	519	519	mA								
IDD6R	274	274	267	267	mA								
IDD6A	526	526	519	519	mA								
IDD7	2037	2109	2066	2129	mA								
IDD8	238	238	231	231	mA								

16GB, 2Gx 72 R-DIMM: HMA82GR7CJR4N

IDD					unit	note	IPP					unit	note
Symbol	2400	2667	2933	3200			Symbol	2400	2667	2933	3200		
IDD0	1141	1165	1120	1146	mA		IPP0	99	99	99	99	mA	
IDD0A	1141	1183	1138	1200	mA		IPP1	117	117	117	117	mA	
IDD1	1308	1353	1328	1373	mA		IPP2N	58	58	58	58	mA	
IDD1A	1362	1371	1310	1337	mA		IPP2P	58	58	58	58	mA	
IDD2N	979	1003	940	984	mA		IPP3N	288	288	288	288	mA	
IDD2NA	979	1003	940	984	mA		IPP3P	288	288	288	288	mA	
IDD2NT	1069	1093	1030	1074	mA		IPP4R	342	342	342	342	mA	
IDD2NL	853	877	814	858	mA		IPP4W	342	342	342	342	mA	
IDD2NG	979	1003	940	984	mA		IPP5B	1134	1134	1134	1134	mA	
IDD2ND	961	985	922	966	mA		IPP5F2	720	738	756	774	mA	
IDD2NP	979	1003	940	984	mA		IPP5F4	630	630	630	630	mA	
IDD2P	648	673	652	695	mA		IPP6N	90	90	90	90	mA	
IDD2Q	943	949	868	894	mA		IPP6E	126	126	126	126	mA	
IDD3N	1159	1183	1138	1182	mA		IPP6R	74	74	74	74	mA	
IDD3NA	1159	1183	1138	1182	mA		IPP6A	126	126	126	126	mA	
IDD3P	846	871	850	893	mA		IPP7	432	468	504	558	mA	
IDD4R	2154	2235	2372	2525	mA		IPP8	58	58	58	58	mA	
IDD4RA	2208	2325	2426	2597	mA								
IDD4RB	534	543	2390	2543	mA								
IDD4W	2082	2199	2282	2417	mA								
IDD4WA	2136	2271	2372	2525	mA								
IDD4WB	534	543	2066	2201	mA								
IDD4WC	2064	2199	2300	2435	mA								
IDD4WP	2352	2505	2624	2813	mA								
IDD5B	4021	4045	3982	4026	mA								
IDD5F2	3049	3091	3046	3108	mA								
IDD5F4	2779	2821	2776	2838	mA								
IDD6N	400	400	393	393	mA								
IDD6E	526	526	519	519	mA								
IDD6R	274	274	267	267	mA								
IDD6A	526	526	519	519	mA								
IDD7	3684	3981	4244	4559	mA								
IDD8	238	238	231	231	mA								

32GB, 4Gx 72 R-DIMM: HMA84GR7CJR4N

IDD					unit	note
Symbol	2400	2667	2933	3200		
IDD0	1627	1669	1642	1686	mA	
IDD0A	1627	1687	1660	1740	mA	
IDD1	1794	1857	1850	1913	mA	
IDD1A	1848	1875	1832	1877	mA	
IDD2N	1465	1507	1462	1524	mA	
IDD2NA	1465	1507	1462	1524	mA	
IDD2NT	1645	1687	1642	1704	mA	
IDD2NL	1213	1255	1210	1272	mA	
IDD2NG	1465	1507	1462	1524	mA	
IDD2ND	1429	1471	1426	1488	mA	
IDD2NP	1465	1507	1462	1524	mA	
IDD2P	990	1033	1030	1091	mA	
IDD2Q	1393	1399	1318	1344	mA	
IDD3N	1825	1867	1858	1920	mA	
IDD3NA	1825	1867	1858	1920	mA	
IDD3P	1386	1429	1426	1487	mA	
IDD4R	2640	2739	2894	3065	mA	
IDD4RA	2694	2829	2948	3137	mA	
IDD4RB	2658	2793	2912	3083	mA	
IDD4W	2568	2703	2804	2957	mA	
IDD4WA	2622	2775	2894	3065	mA	
IDD4WB	2388	2505	2588	2741	mA	
IDD4WC	2550	2703	2822	2975	mA	
IDD4WP	2838	3009	3146	3353	mA	
IDD5B	4507	4549	4504	4566	mA	
IDD5F2	3535	3595	3568	3648	mA	
IDD5F4	3265	3325	3298	3378	mA	
IDD6N	778	778	771	771	mA	
IDD6E	1030	1030	1023	1023	mA	
IDD6R	526	526	519	519	mA	
IDD6A	1030	1030	1023	1023	mA	
IDD7	4170	4485	4766	5099	mA	
IDD8	454	454	447	447	mA	

IPP					unit	note
Symbol	2400	2667	2933	3200		
IPP0	157	157	157	157	mA	
IPP1	175	175	175	175	mA	
IPP2N	115	115	115	115	mA	
IPP2P	115	115	115	115	mA	
IPP3N	576	576	576	576	mA	
IPP3P	576	576	576	576	mA	
IPP4R	400	400	400	400	mA	
IPP4W	400	400	400	400	mA	
IPP5B	1192	1192	1192	1192	mA	
IPP5F2	778	796	814	832	mA	
IPP5F4	688	688	688	688	mA	
IPP6N	180	180	180	180	mA	
IPP6E	252	252	252	252	mA	
IPP6R	148	148	148	148	mA	
IPP6A	252	252	252	252	mA	
IPP7	490	526	562	616	mA	
IPP8	115	115	115	115	mA	

Module Dimensions

1Gx72 - HMA81GR7CJR8N

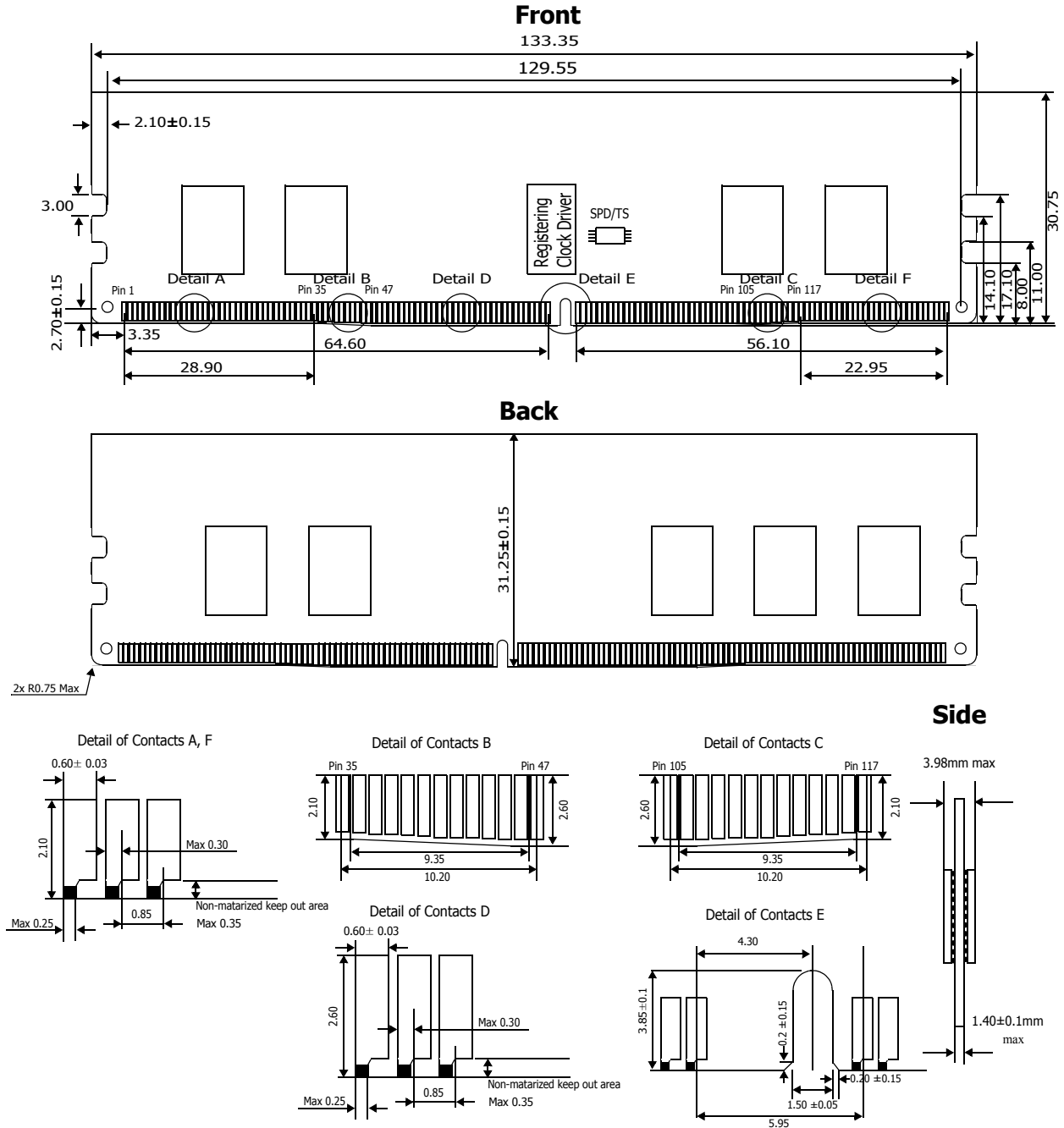

Note:

1. ±0.13 tolerance on all dimensions unless otherwise stated.

Units: millimeters

2Gx72 - HMA82GR7CJR8N

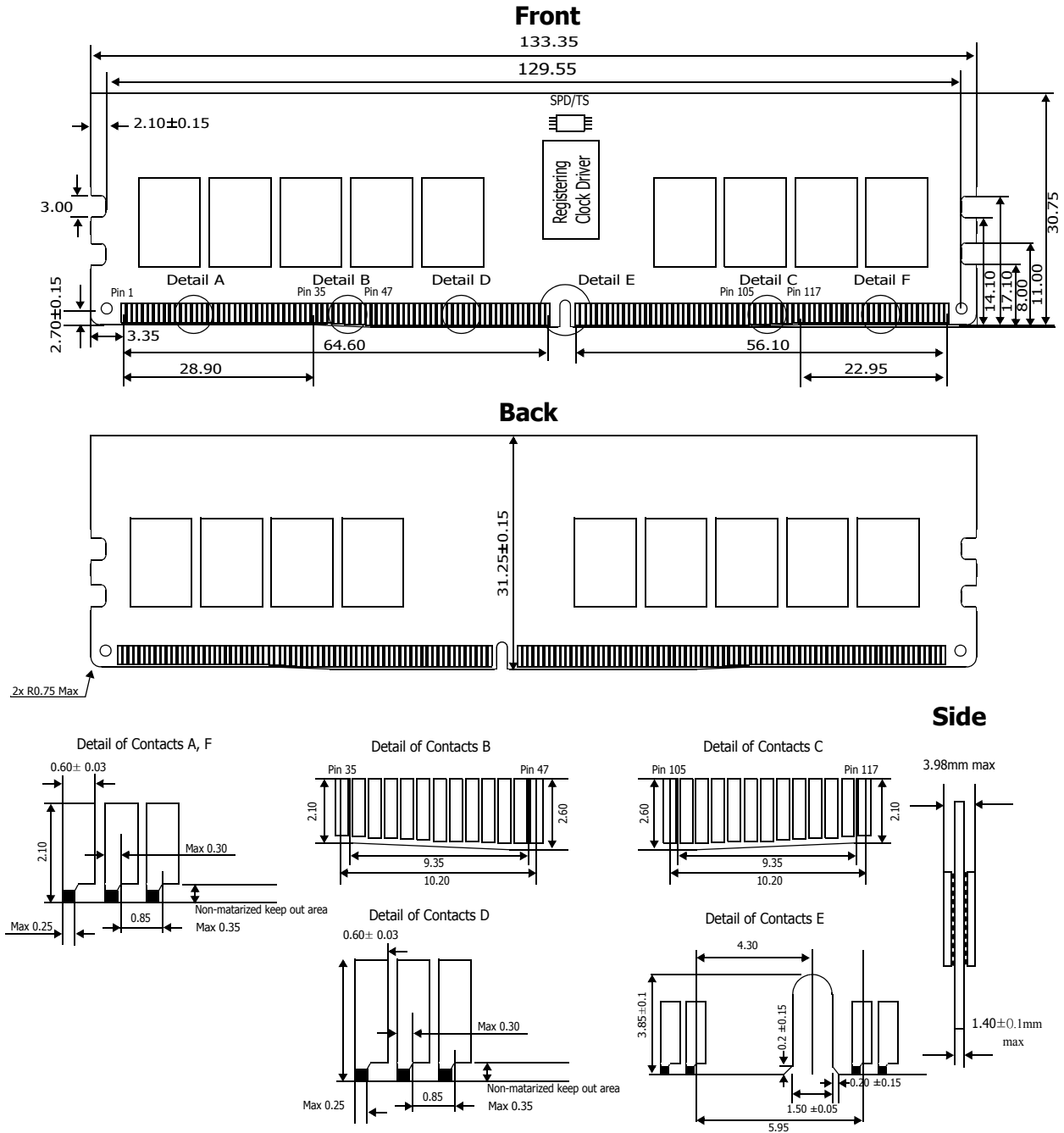

Note:

1. ±0.13 tolerance on all dimensions unless otherwise stated.

Units: millimeters

2Gx72 - HMA82GR7CJR4N

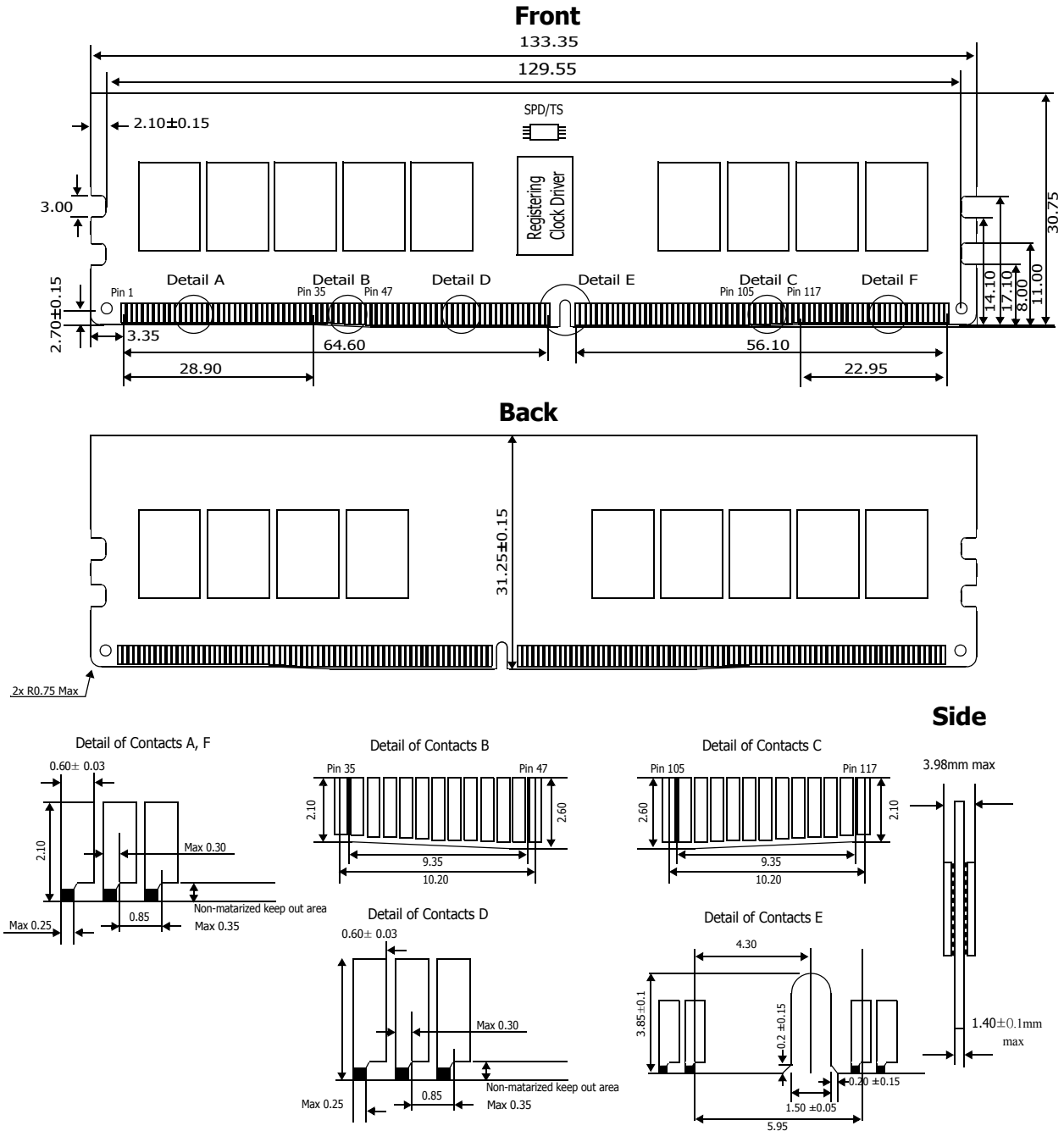

Note:

1. ±0.13 tolerance on all dimensions unless otherwise stated.

Units: millimeters

4Gx72 - HMA84GR7CJR4N

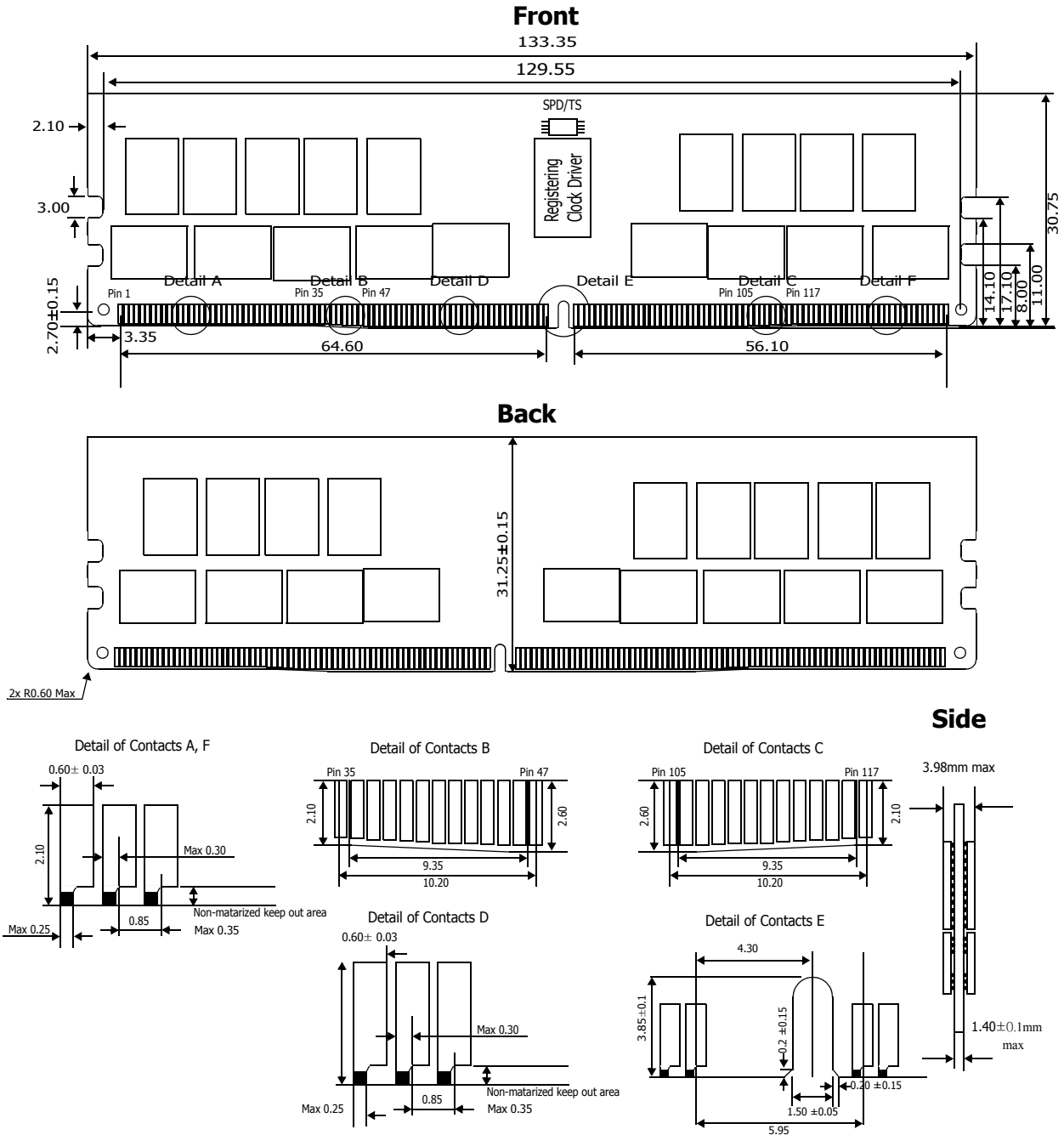

Note:

- ±0.13 tolerance on all dimensions unless otherwise stated.

Units: millimeters